

To all our customers

---

## **Regarding the change of names mentioned in the document, such as Hitachi Electric and Hitachi XX, to Renesas Technology Corp.**

---

The semiconductor operations of Mitsubishi Electric and Hitachi were transferred to Renesas Technology Corporation on April 1st 2003. These operations include microcomputer, logic, analog and discrete devices, and memory chips other than DRAMs (flash memory, SRAMs etc.) Accordingly, although Hitachi, Hitachi, Ltd., Hitachi Semiconductors, and other Hitachi brand names are mentioned in the document, these names have in fact all been changed to Renesas Technology Corp. Thank you for your understanding. Except for our corporate trademark, logo and corporate statement, no changes whatsoever have been made to the contents of the document, and these changes do not constitute any alteration to the contents of the document itself.

Renesas Technology Home Page: <http://www.renesas.com>

Renesas Technology Corp.  
Customer Support Dept.  
April 1, 2003

## Cautions

Keep safety first in your circuit designs!

1. Renesas Technology Corporation puts the maximum effort into making semiconductor products better and more reliable, but there is always the possibility that trouble may occur with them. Trouble with semiconductors may lead to personal injury, fire or property damage.  
Remember to give due consideration to safety when making your circuit designs, with appropriate measures such as (i) placement of substitutive, auxiliary circuits, (ii) use of nonflammable material or (iii) prevention against any malfunction or mishap.

Notes regarding these materials

1. These materials are intended as a reference to assist our customers in the selection of the Renesas Technology Corporation product best suited to the customer's application; they do not convey any license under any intellectual property rights, or any other rights, belonging to Renesas Technology Corporation or a third party.
2. Renesas Technology Corporation assumes no responsibility for any damage, or infringement of any third-party's rights, originating in the use of any product data, diagrams, charts, programs, algorithms, or circuit application examples contained in these materials.
3. All information contained in these materials, including product data, diagrams, charts, programs and algorithms represents information on products at the time of publication of these materials, and are subject to change by Renesas Technology Corporation without notice due to product improvements or other reasons. It is therefore recommended that customers contact Renesas Technology Corporation or an authorized Renesas Technology Corporation product distributor for the latest product information before purchasing a product listed herein.  
The information described here may contain technical inaccuracies or typographical errors. Renesas Technology Corporation assumes no responsibility for any damage, liability, or other loss rising from these inaccuracies or errors.  
Please also pay attention to information published by Renesas Technology Corporation by various means, including the Renesas Technology Corporation Semiconductor home page (<http://www.renesas.com>).
4. When using any or all of the information contained in these materials, including product data, diagrams, charts, programs, and algorithms, please be sure to evaluate all information as a total system before making a final decision on the applicability of the information and products. Renesas Technology Corporation assumes no responsibility for any damage, liability or other loss resulting from the information contained herein.
5. Renesas Technology Corporation semiconductors are not designed or manufactured for use in a device or system that is used under circumstances in which human life is potentially at stake. Please contact Renesas Technology Corporation or an authorized Renesas Technology Corporation product distributor when considering the use of a product contained herein for any specific purposes, such as apparatus or systems for transportation, vehicular, medical, aerospace, nuclear, or undersea repeater use.
6. The prior written approval of Renesas Technology Corporation is necessary to reprint or reproduce in whole or in part these materials.
7. If these products or technologies are subject to the Japanese export control restrictions, they must be exported under a license from the Japanese government and cannot be imported into a country other than the approved destination.  
Any diversion or reexport contrary to the export control laws and regulations of Japan and/or the country of destination is prohibited.
8. Please contact Renesas Technology Corporation for further details on these materials or the products contained therein.

# H8S/2168F E10A Emulator

User's Manual



ADE-702-371

Rev. 1.0  
02/19/03  
Hitachi, Ltd.

HS2168KCM01HE

## Cautions

1. Hitachi neither warrants nor grants licenses of any rights of Hitachi's or any third party's patent, copyright, trademark, or other intellectual property rights for information contained in this document. Hitachi bears no responsibility for problems that may arise with third party's rights, including intellectual property rights, in connection with use of the information contained in this document.
2. Products and product specifications may be subject to change without notice. Confirm that you have received the latest product standards or specifications before final design, purchase or use.
3. Hitachi makes every attempt to ensure that its products are of high quality and reliability. However, contact Hitachi's sales office before using the product in an application that demands especially high quality and reliability or where its failure or malfunction may directly threaten human life or cause risk of bodily injury, such as aerospace, aeronautics, nuclear power, combustion control, transportation, traffic, safety equipment or medical equipment for life support.
4. Design your application so that the product is used within the ranges guaranteed by Hitachi particularly for maximum rating, operating supply voltage range, heat radiation characteristics, installation conditions and other characteristics. Hitachi bears no responsibility for failure or damage when used beyond the guaranteed ranges. Even within the guaranteed ranges, consider normally foreseeable failure rates or failure modes in semiconductor devices and employ systemic measures such as fail-safes, so that the equipment incorporating Hitachi product does not cause bodily injury, fire or other consequential damage due to operation of the Hitachi product.
5. This product is not designed to be radiation resistant.
6. No one is permitted to reproduce or duplicate, in any form, the whole or part of this document without written approval from Hitachi.
7. Contact Hitachi's sales office for any questions regarding this document or Hitachi semiconductor products.

# IMPORTANT INFORMATION

## READ FIRST

- **READ** this user's manual before using this emulator product.
- **KEEP** the user's manual handy for future reference.

**Do not attempt to use the emulator product until you fully understand its mechanism.**

### **Emulator Product:**

Throughout this document, the term "emulator product" shall be defined as the following products produced only by Hitachi, Ltd. excluding all subsidiary products.

- Emulator
- User system interface cable

The user system or a host computer is not included in this definition.

### **Purpose of the Emulator Product:**

This emulator product is a software and hardware development tool for systems employing the Hitachi microcomputer. This emulator product must only be used for the above purpose.

### **Limited Applications:**

This emulator product is not authorized for use in MEDICAL, atomic energy, aeronautical or space technology applications without consent of the appropriate officer of a Hitachi sales company. Such use includes, but is not limited to, use in life support systems. Buyers of this emulator product must notify the relevant Hitachi sales offices before planning to use the product in such applications.

### **Improvement Policy:**

Hitachi, Ltd. (including its subsidiaries, hereafter collectively referred to as Hitachi) pursues a policy of continuing improvement in design, performance, and safety of the emulator product. Hitachi reserves the right to change, wholly or partially, the specifications, design, user's manual, and other documentation at any time without notice.

### **Target User of the Emulator Product:**

This emulator product should only be used by those who have carefully read and thoroughly understood the information and restrictions contained in the user's manual. Do not attempt to use the emulator product until you fully understand its mechanism.

It is highly recommended that first-time users be instructed by users that are well versed in the operation of the emulator product.

## **LIMITED WARRANTY**

Hitachi warrants its emulator products to be manufactured in accordance with published specifications and free from defects in material and/or workmanship. Hitachi, at its option, will replace any emulator products returned intact to the factory, transportation charges prepaid, which Hitachi, upon inspection, shall determine to be defective in material and/or workmanship. The foregoing shall constitute the sole remedy for any breach of Hitachi's warranty. See the Hitachi warranty booklet for details on the warranty period. This warranty extends only to you, the original Purchaser. It is not transferable to anyone who subsequently purchases the emulator product from you. Hitachi is not liable for any claim made by a third party or made by you for a third party.

## **DISCLAIMER**

HITACHI MAKES NO WARRANTIES, EITHER EXPRESS OR IMPLIED, ORAL OR WRITTEN, EXCEPT AS PROVIDED HEREIN, INCLUDING WITHOUT LIMITATION THEREOF, WARRANTIES AS TO MARKETABILITY, MERCHANTABILITY, FITNESS FOR ANY PARTICULAR PURPOSE OR USE, OR AGAINST INFRINGEMENT OF ANY PATENT. IN NO EVENT SHALL HITACHI BE LIABLE FOR ANY DIRECT, INCIDENTAL OR CONSEQUENTIAL DAMAGES OF ANY NATURE, OR LOSSES OR EXPENSES RESULTING FROM ANY DEFECTIVE EMULATOR PRODUCT, THE USE OF ANY EMULATOR PRODUCT, OR ITS DOCUMENTATION, EVEN IF ADVISED OF THE POSSIBILITY OF SUCH DAMAGES. EXCEPT AS EXPRESSLY STATED OTHERWISE IN THIS WARRANTY, THIS EMULATOR PRODUCT IS SOLD "AS IS", AND YOU MUST ASSUME ALL RISK FOR THE USE AND RESULTS OBTAINED FROM THE EMULATOR PRODUCT.

**State Law:**

Some states do not allow the exclusion or limitation of implied warranties or liability for incidental or consequential damages, so the above limitation or exclusion may not apply to you. This warranty gives you specific legal rights, and you may have other rights which may vary from state to state.

**The Warranty is Void in the Following Cases:**

Hitachi shall have no liability or legal responsibility for any problems caused by misuse, abuse, misapplication, neglect, improper handling, installation, repair or modifications of the emulator product without Hitachi's prior written consent or any problems caused by the user system.

**All Rights Reserved:**

This user's manual and emulator product are copyrighted and all rights are reserved by Hitachi. No part of this user's manual, all or part, may be reproduced or duplicated in any form, in hard-copy or machine-readable form, by any means available without Hitachi's prior written consent.

**Other Important Things to Keep in Mind:**

1. Circuitry and other examples described herein are meant merely to indicate the characteristics and performance of Hitachi's semiconductor products. Hitachi assumes no responsibility for any intellectual property claims or other problems that may result from applications based on the examples described herein.
2. No license is granted by implication or otherwise under any patents or other rights of any third party or Hitachi.

**Figures:**

Some figures in this user's manual may show items different from your actual system.

**MCU names:**

This user's manual uses H8S/xxxx as an example of the MCU names.

**Limited Anticipation of Danger:**

Hitachi cannot anticipate every possible circumstance that might involve a potential hazard. The warnings in this user's manual and on the emulator product are therefore not all inclusive. Therefore, you must use the emulator product safely at your own risk.

# SAFETY PAGE

## READ FIRST

- **READ** this user's manual before using this emulator product.
- **KEEP the user's manual handy for future reference.**

Do not attempt to use the emulator product until you fully understand its mechanism.

## DEFINITION OF SIGNAL WORDS



This is the safety alert symbol. It is used to alert you to potential personal injury hazards. Obey all safety messages that follow this symbol to avoid possible injury or death.



**DANGER** indicates an imminently hazardous situation which, if not avoided, will result in death or serious injury.



**WARNING** indicates a potentially hazardous situation which, if not avoided, could result in death or serious injury.



**CAUTION** indicates a potentially hazardous situation which, if not avoided, may result in minor or moderate injury.



**CAUTION** used without the safety alert symbol indicates a potentially hazardous situation which, if not avoided, may result in property damage.

**NOTE** emphasizes essential information.



# **WARNING**

**Observe the precautions listed below. Failure to do so will result in a FIRE HAZARD and will damage the user system and the emulator product or will result in PERSONAL INJURY. The USER PROGRAM will be LOST.**

- 1. Do not repair or remodel the emulator product by yourself for electric shock prevention and quality assurance.**
- 2. Always switch OFF the host computer and user system before connecting or disconnecting any CABLES or PARTS.**
- 3. Connect the connectors in the user system and in the user interface cable by confirming the correct direction.**
- 4. If the PCI interface board for the E6000 or E8000 emulator (HS6000EIC01H) and the E10A emulator PCI card are mounted on the same host computer, the connectors may be illegally connected.**

# Warnings on Emulator Usage

Be sure to read and understand the warnings below before using this emulator. Note that these are the main warnings, not the complete list.

## **WARNING**

**Always switch OFF the host computer and user system before connecting or disconnecting any CABLES or PARTS.**

**Failure to do so will result in a FIRE HAZARD and will damage the user system and the emulator product or will result in PERSONAL INJURY. The USER PROGRAM will be LOST.**

## **CAUTION**

**Place the host computer and user system so that no cable is bent or twisted. A bent or twisted cable will impose stress on the user interface leading to connection or contact failure.**

**Make sure that the host computer and the user system are placed in a secure position so that they do not move during use nor impose stress on the user interface.**

# CAUTION

**This equipment has been tested and found to comply with the limits for a Class A digital device, pursuant to part 15 of the FCC Rules. These limits are designed to provide reasonable protection against harmful interference when the equipment is operated in a commercial environment. This equipment generates, uses, and can radiate radio frequency energy and, if not installed and used in accordance with the instruction manual, may cause harmful interference to radio communications. Operation of this equipment in a residential area is likely to cause harmful interference in which case the user will be required to correct the interference at his own expense.**



# Preface

Thank you for purchasing the E10A emulator.

## **CAUTION**

**READ section 2, Preparation before Use, of this User's Manual before using the emulator product. Incorrect operation will damage the user system and the emulator product.**

This emulator is an efficient development tool for software and hardware of user systems based on Hitachi's original microprocessor. The emulator operates using the Hitachi debugging interface (hereafter referred to as the HDI), which is the interface program that runs on Microsoft® Windows® 98, Microsoft® Windows® Me, Microsoft® Windows NT®, Microsoft® Windows® 2000, or Windows® XP operating system.

This manual describes the functions and operating procedures of the E10A emulator. Sections 1 to 5 describe common features of all types of E10A emulators. Section 6 describes supplements to the E10A emulator.

This manual consists of six sections. The information contained in each section is summarized below:

- Section 1, Overview, gives the emulator overview.
- Section 2, Preparation before Use, gives instructions for first-time users, such as preparation before use and system connection.
- Section 3, Tutorial, describes HDI operating examples.
- Section 4, Descriptions of Windows, describes HDI windows for operating the emulator.
- Section 5, Command-line Functions describes how to input HDI commands and command types.
- Section 6, H8S/xxxx E10A Emulator Specifications describes the features of the E10A emulator for each MCU. Section 7 describes the important information of the E10A emulator according to emulator products. Read these sections before using the E10A emulator.

The HDI installation disks are provided by the CD-R. Refer to the descriptions in the manuals of the host computer or operating system.

## **Related Manuals:**

- Supplementary Informations
- Hitachi Debugging Interface User's Manual (HS6400DIW5SE)
- H8S, H8/300 Series C/C++ Compiler, Assembler, Optimizing Linkage Editor User's Manual
- Hardware Manual for each MCU
- Programming Manual for each MCU

- Notes:**
- 1. IBM PC is a registered trademark of International Business Machines Corporation.**
  - 2. Microsoft<sup>®</sup>, Windows<sup>®</sup>, and Windows NT<sup>®</sup> are registered trademarks of Microsoft Corporation in the United States and/or other countries.**  
**Microsoft<sup>®</sup> Windows<sup>®</sup> 98 operating system is referred to as Windows<sup>®</sup> 98 in this user's manual.**  
**Microsoft<sup>®</sup> Windows<sup>®</sup> Millennium Edition operating system is referred to as Windows<sup>®</sup> Me in this user's manual.**  
**Microsoft<sup>®</sup> Windows NT<sup>®</sup> operating system is referred to as Windows NT<sup>®</sup> in this user's manual.**  
**Microsoft<sup>®</sup> Windows<sup>®</sup> 2000 operating system is referred to as Windows<sup>®</sup> 2000 in this user's manual.**  
**Microsoft<sup>®</sup> Windows<sup>®</sup> XP operating system is referred to as Windows<sup>®</sup> XP in this user's manual.**

# Contents

Section 1 Overview .....	1
1.1 Warnings .....	3
1.2 Environmental Conditions.....	4
1.3 Components.....	6
Section 2 Preparation before Use .....	7
2.1 Emulator Preparation.....	7
2.2 HDI Installation.....	8
2.2.1 Installing under Windows® 98 or Windows® Me Operating System.....	8
2.2.2 Installing under Windows NT® 4.0 Operating System.....	9
2.2.3 Installing under Windows® 2000 or Windows® XP Operating System .....	10
2.3 Connecting the Host Computer with the Card Emulator.....	11
2.4 Connecting the Card Emulator with the User System .....	12
2.5 System Check.....	14
2.5.1 H8S/xxxx E10A Emulator Mode .....	17
2.5.2 Writing H8S/xxxx E10A Flash memory Mode.....	20
2.6 Ending the HDI .....	23
2.7 Uninstalling the HDI .....	24
Section 3 Tutorial .....	25
3.1 Introduction .....	25
3.2 Running the HDI .....	26
3.3 [HDI] Window .....	27
3.4 Setting up the Emulator.....	28
3.5 Setting the [Configuration] Dialog Box .....	28
3.6 Downloading the Tutorial Program.....	30
3.6.1 Downloading the Tutorial Program.....	30
3.6.2 Displaying the Source Program.....	31
3.7 Setting the Software Breakpoint.....	33
3.8 Setting Registers.....	34
3.9 Executing the Program .....	36
3.10 Reviewing Breakpoints .....	39
3.11 Viewing Memory .....	40
3.12 Watching Variables .....	41
3.13 Stepping Through a Program .....	44
3.13.1 Executing [Step In] Command.....	45
3.13.2 Executing [Step Out] Command .....	46
3.13.3 Executing [Step Over] Command.....	48
3.14 Displaying Local Variables .....	50

3.15	Break Function .....	51
3.15.1	Software Break Function.....	51
3.16	Hardware Break Function .....	57
3.17	Trace Function.....	64
3.18	What Next?.....	65
<b>Section 4 Descriptions of Windows .....</b>		<b>67</b>
4.1	HDI Windows .....	67
4.2	Descriptions of Each Window.....	70
4.2.1	[Configuration] Dialog Box .....	70
4.2.2	[E10A Driver Details] Dialog Box.....	75
4.2.3	[Breakpoints] Window .....	76
4.2.4	[Break] Dialog Box .....	78
4.2.5	[Breakpoint] Dialog Box.....	84
4.2.6	[Break condition] Dialog Box .....	86
4.2.7	[Break condition] Dialog Box Pages.....	88
4.2.8	[Trace] Window .....	92
4.2.9	[System Status] Window .....	94
<b>Section 5 Command-line Functions .....</b>		<b>97</b>
5.1	Table and Symbol Description.....	97
5.1.1	Format .....	97
5.1.2	Parameter Input .....	97
5.1.3	Examples .....	98
5.1.4	Related Items.....	98
5.2	Command Descriptions .....	99
5.2.1	BREAKCONDITION_CLEAR: BCC .....	100
5.2.2	BREAKCONDITION_DISPLAY: BCD .....	101
5.2.3	BREAKCONDITION_ENABLE: BCE.....	102
5.2.4	BREAKCONDITION_SET: BCS.....	103
5.2.5	BREAKPOINT: BP.....	106
5.2.6	BREAKPOINT_CLEAR: BC .....	107
5.2.7	BREAKPOINT_DISPLAY: BD .....	108
5.2.8	BREAKPOINT_ENABLE: BE.....	109
5.2.9	DEVICE_TYPE: DE.....	110
5.2.10	GO_OPTION: GP .....	111
5.2.11	JTAG_CLOCK: JCK .....	112
5.2.12	REFRESH: RF .....	114
5.2.13	RESET: RE .....	115
5.2.14	STATUS: STS.....	116
5.2.15	STEP_INTERRUPT: SI.....	117
5.2.16	TRACE_DISPLAY: TD.....	118



Section 6 H8S/2168F E10A Emulator Specifications .....	119
6.1 Components of the Emulator .....	119
6.2 Pin Arrangement of the Hitachi-UDI Port Connector .....	120
6.3 Example of Emulator Connection .....	121
6.4 Differences between the H8S/2168F and the Emulator .....	125
6.5 The H8S/2168F E10A Emulator Functions.....	126
6.5.1 Emulator Driver Selection.....	126
6.5.2 Hardware Break Functions.....	126
6.5.3 Notes on Setting the [Breakpoint] Dialog Box.....	128
6.5.4 Note on Using the JTAG Clock (TCK).....	128
6.5.5 Trace Function.....	128
6.5.6 Notes on HDI .....	129

# Figures

Figure 1.1	System Configuration with the Emulator (PCMCIA Card Emulator Used).....	1
Figure 1.2	System Configuration with the Emulator (PCI Card Emulator Used).....	2
Figure 2.1	Emulator Preparation Flow Chart.....	7
Figure 2.2	Inserting the PCMCIA Card Emulator into the Host Computer.....	11
Figure 2.3	Inserting the PCI Card Emulator into the Host Computer.....	11
Figure 2.4	Connecting the User System Interface Cable to the User System.....	12
Figure 2.5	[Start] Menu.....	14
Figure 2.6	[Select Session] Dialog Box.....	15
Figure 2.7	[E10A Driver Details] Dialog Box.....	16
Figure 2.8	[System Clock] Dialog Box.....	17
Figure 2.9	[ID Code] Dialog Box.....	17
Figure 2.10	[HDI] Status Bar.....	17
Figure 2.11	[H-UDI Connector Disconnected] Dialog Box.....	18
Figure 2.12	[Can not find /RESET signal] Dialog Box.....	18
Figure 2.13	[Check the connection] Dialog Box.....	19
Figure 2.14	[COMMUNICATION TIMEOUT ERROR] Dialog Box.....	19
Figure 2.15	[INVALID ASERAM FIRMWARE!] Dialog Box.....	19
Figure 2.16	[Unable to restore the previous driver settings] Dialog Box.....	20
Figure 2.17	[System Clock] Dialog Box.....	20
Figure 2.18	[Load Program] Dialog Box.....	21
Figure 2.19	Checksum Value after Downloading the Program.....	21
Figure 2.20	[HDI] Dialog Box.....	21
Figure 2.21	[Continue?] Window.....	22
Figure 2.22	[Connector disconnected] Dialog Box.....	22
Figure 2.23	[Flash memory erase error!] Dialog Box.....	22
Figure 2.24	[Exit HDI] Dialog Box.....	23
Figure 2.25	[Save session] Dialog Box.....	23
Figure 3.1	[Start] Menu.....	26
Figure 3.2	[HDI] Window.....	27
Figure 3.3	[Configuration] Dialog Box.....	28
Figure 3.4	[Load Program] Dialog Box.....	30
Figure 3.5	[HDI] Dialog Box.....	30
Figure 3.6	[Open] Dialog Box.....	31
Figure 3.7	[Program] Window (Displaying the Source Program).....	32
Figure 3.8	[Program] Window (Setting a Software Breakpoint).....	33
Figure 3.9	[Registers] Window.....	34
Figure 3.10	[Register] Dialog Box (PC).....	34
Figure 3.11	[Register] Dialog Box (ER7).....	35
Figure 3.12	[Go] Button.....	36
Figure 3.13	[Reset Go] Button.....	36

Figure 3.14	[Program] Window (Break Status) .....	36
Figure 3.15	[System Status] Window .....	37
Figure 3.16	[Breakpoints] Window.....	39
Figure 3.17	[Open Memory Window] Dialog Box .....	40
Figure 3.18	[Memory] Window .....	40
Figure 3.19	[Instant Watch] Dialog Box .....	41
Figure 3.20	[Watch] Window (Displaying the Array) .....	42
Figure 3.21	[Add Watch] Dialog Box .....	42
Figure 3.22	[Watch] Window (Displaying the Variable).....	43
Figure 3.23	[Watch] Window (Displaying Array Elements) .....	43
Figure 3.24	[Step In] Button .....	45
Figure 3.25	[Program] Window (Step In) .....	45
Figure 3.26	[Step Out] Button.....	46
Figure 3.27	[Program] Window (Step Out) .....	46
Figure 3.28	[Program] Window (Step In → Step In) .....	47
Figure 3.29	[Program] Window (Before Step Over Execution) .....	48
Figure 3.30	[Step Over] Button.....	48
Figure 3.31	[Program] Window (Step Over) .....	49
Figure 3.32	[Locals] Window .....	50
Figure 3.33	[Breakpoints] Window (Before Software Breakpoint Setting) .....	51
Figure 3.34	[Point] Page ([Break] Dialog Box).....	52
Figure 3.35	[Breakpoint] Dialog Box .....	53
Figure 3.36	[Point] Page ([Break] Dialog Box) (After Software Breakpoint Setting).....	54
Figure 3.37	[Breakpoints] Window (Software Breakpoint Setting).....	55
Figure 3.38	[Program] Window at Execution Stop (Software Break) .....	55
Figure 3.39	Displayed Contents of the [System Status] Window (Software Break).....	56
Figure 3.40	[Breakpoints] Window (Before Hardware Break Condition Setting).....	57
Figure 3.41	[Condition] Page ([Break] Dialog Box).....	58
Figure 3.42	[condition] Page ([Break condition 1] Dialog Box) .....	59
Figure 3.43	[Break] Dialog Box (After Hardware Break Condition Setting) .....	60
Figure 3.44	[Breakpoints] Window ([Break condition 1] Setting).....	61
Figure 3.45	[Program] Window at Execution Stop (Break condition 1).....	62
Figure 3.46	Displayed Contents of the [System Status] Window (Break condition 1).....	63
Figure 3.47	[Trace] Window .....	64
Figure 4.1	[Configuration] Dialog Box.....	70
Figure 4.2	[General] Page ([Configuration] Dialog Box) .....	72
Figure 4.3	Warning Message Box.....	74
Figure 4.4	[E10A Driver Details] Dialog Box .....	75
Figure 4.5	[Breakpoints] Window.....	76
Figure 4.6	[Break] Dialog Box.....	78
Figure 4.7	[Point] Page ([Break] Dialog Box) .....	80
Figure 4.8	[Condition] Page ([Break] Dialog Box).....	82
Figure 4.9	[Breakpoint] Dialog Box .....	84

Figure 4.10	[Break condition 1] Dialog Box .....	86
Figure 4.11	[condition] Page.....	89
Figure 4.12	[Trace] Window.....	92
Figure 4.13	[System Status] Window .....	94
Figure 6.1	Pin Arrangement of the Hitachi-UDI Port Connector (14-Pin Type).....	120
Figure 6.2	Example of Emulator Connection .....	121
Figure 6.3	Connection of Emulator and the MCU .....	122
Figure 6.4	#MD2 Pin and Emulator.....	122
Figure 6.5	Connection of the #RES Pin.....	123
Figure 6.6	Connection of the FWE Pin.....	123
Figure 6.7	Interface Circuit in the Emulator (Reference) .....	124

## Tables

Table 1.1	Environmental Conditions .....	4
Table 1.2	Operating Environments .....	5
Table 2.1	Recommended Connector .....	12
Table 3.1	Tutorial Program: Configuration and Parts.....	25
Table 3.2	Setting the [Configuration] Dialog Box .....	29
Table 3.3	Contents of the [System Status] Window.....	38
Table 3.4	Step Option .....	44
Table 4.1	HDI Window Menus and Related Manual Entries.....	67
Table 4.2	[Configuration] Dialog Box Page .....	71
Table 4.3	[General] Page Options .....	73
Table 4.4	[E10A Driver Details] Dialog Box Option .....	75
Table 4.5	[Breakpoints] Window Display Items.....	77
Table 4.6	[Breakpoints] Window Pop-up Menu Operation .....	77
Table 4.7	[Break] Dialog Box Pages.....	79
Table 4.8	[Point] Page Options .....	81
Table 4.9	[Condition] Page Options.....	83
Table 4.10	[Address] Page Options.....	85
Table 4.11	Setting Conditions in [Break condition] Dialog Box .....	88
Table 4.12	[Break condition] Dialog Box Pages.....	88
Table 4.13	[Address] Group Box Options .....	90
Table 4.14	Radio Button Options.....	90
Table 4.15	[Data] Group Box Options .....	90
Table 4.16	[Read/Write] Group Box Options .....	91
Table 4.17	[Trace] Window Display Items .....	93
Table 4.18	[System Status] Window Display Items.....	95
Table 5.1	E10A HDI Commands .....	99
Table 5.2	BREAKCONDITION_CLEAR Command Parameter .....	100
Table 5.3	BREAKCONDITION_DISPLAY Command Parameter.....	101
Table 5.4	BREAKCONDITION_ENABLE Command Parameter.....	102
Table 5.5	BREAKCONDITION_SET Command Parameters .....	104
Table 5.6	BREAKPOINT Command Parameter.....	106
Table 5.7	BREAKPOINT_CLEAR Command Parameter.....	107
Table 5.8	BREAKPOINT_DISPLAY Command Parameter .....	108
Table 5.9	BREAKPOINT_ENABLE Command Parameters.....	109
Table 5.10	DEVICE_TYPE Command Parameter .....	110
Table 5.11	GO_OPTION Command Parameter.....	111
Table 5.12	JTAG_CLOCK Command Parameter.....	112
Table 5.13	REFRESH Command Parameter .....	114
Table 5.14	RESET Command Parameter.....	115
Table 5.15	STATUS Command Parameter .....	116

Table 5.16	STEP_INTERRUPT Command Parameter.....	117
Table 5.17	TRACE_DISPLAY Command Parameter.....	118
Table 6.1	Components of the Emulator (HS2168KCM01H or HS2168KCI01H).....	119
Table 6.2	Register Initial Values at Emulator Power-On.....	125
Table 6.3	Type Name and Driver.....	126
Table 6.4	Hardware Break Condition Specification Items.....	126
Table 6.5	Conditions Set in [Break condition] Dialog Box.....	127
Table 6.6	Conditions Set by BREAKCONDITION_SET Command.....	127

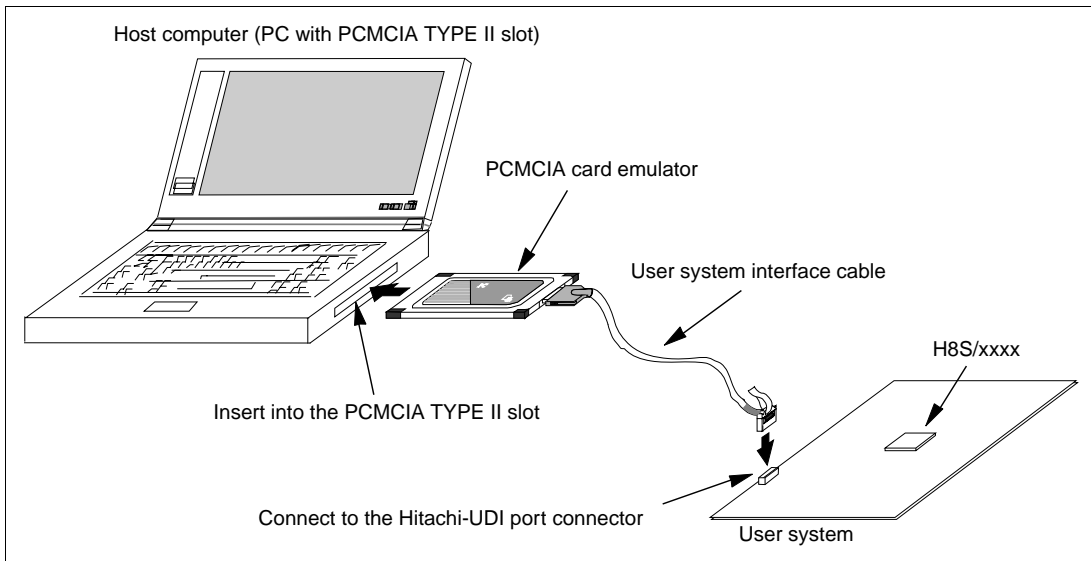
# Section 1 Overview

The E10A emulator (hereafter referred to as the emulator) is a software and hardware development support tool for application systems using the microprocessor developed by Hitachi, Ltd.

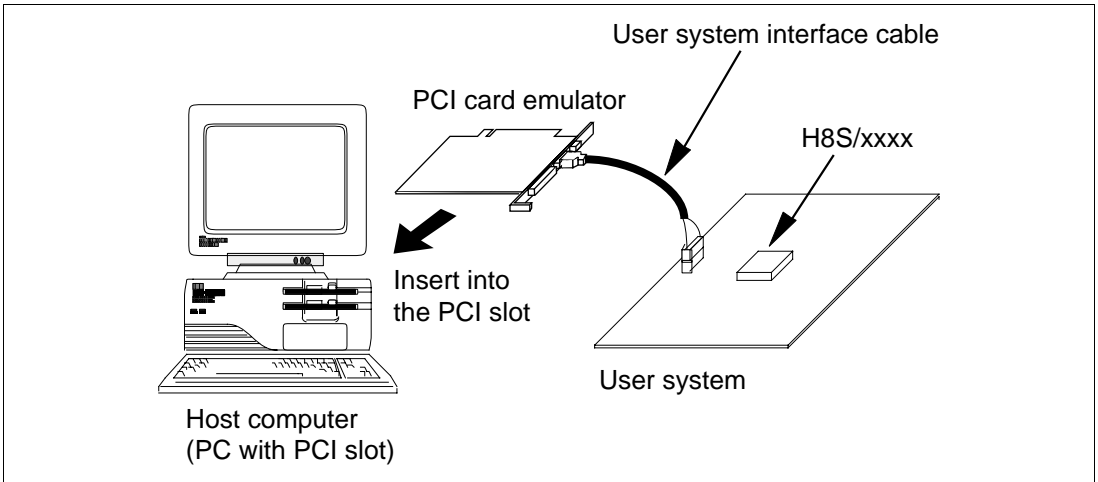
The PCMCIA card emulator or PCI card emulator (hereafter referred to as the card emulator), which is the main unit of the emulator, is connected, through the Hitachi-UDI (user debug interface) port, to the user system. The user system can be debugged under the conditions similar to the actual application conditions. The emulator enables debugging anywhere indoors or out. The host computer for controlling the emulator must be an IBM PC compatible machine with a PCMCIA TYPE II or PCI slot.

Figures 1.1 and 1.2 show the system configuration using the emulator.

**Note: The Hitachi-UDI is an interface compatible with the Joint Test Action Group (JTAG) specifications.**



**Figure 1.1 System Configuration with the Emulator (PCMCIA Card Emulator Used)**



**Figure 1.2 System Configuration with the Emulator (PCI Card Emulator Used)**

The emulator provides the following features:

- Excellent cost-performance card emulator  
Compactness and low price are implemented using the PCMCIA interface or the PCI interface.
- Realtime emulation  
Realtime emulation of the user system is enabled at the maximum operating frequency of the CPU.
- Excellent operability  
Using the Hitachi Debugging Interface (HDI) on the Microsoft® Windows® 98, Microsoft® Windows® Me, Microsoft® Windows NT®, Microsoft® Windows® 2000, and Microsoft® Windows® XP operating systems enable user program debugging using a pointing device such as a mouse. The HDI enables high-speed downloading of load module files.
- Various debugging functions  
Various break and trace functions enable efficient debugging. Breakpoints and break conditions can be set by the specific window, trace information can be displayed on a window, and command-line functions can be used.
- Memory access during emulation  
During emulation, the memory contents can be read and modified.
- Debugging of the user system in the final development stage  
The user system can be debugged under conditions similar to the actual application conditions.
- Compact debugging environment  
When the card emulator specific to the PCMCIA interface is used, a laptop computer can be used as a host computer, creating a debugging environment in any place.



## 1.1 Warnings

### **CAUTION**

**READ the following warnings before using the emulator product. Incorrect operation will damage the user system and the emulator product. The USER PROGRAM will be LOST.**

1. Check all components against the component list after unpacking the emulator.
2. Never place heavy objects on the casing.
3. Protect the emulator from excessive impacts and stresses. For details, refer to section 1.2, Environmental Conditions.
4. Do not insert the emulator into any slot (PCMCIA TYPE II slot or PCI slot) other than the specified one.
5. When moving the host computer or user system, take care not to vibrate or damage it.
6. After connecting the cable, check that it is connected correctly. For details, refer to section 2, Preparation before Use.
7. Supply power to the connected equipment after connecting all cables. Cables must not be connected or removed while the power is on.

## 1.2 Environmental Conditions

### **CAUTION**

**Observe the conditions listed in tables 1.1 and 1.2 when using the emulator. Failure to do so will damage the user system and the emulator product. The USER PROGRAM will be LOST.**

**Table 1.1 Environmental Conditions**

<b>Item</b>	<b>Specifications</b>
Temperature	Operating: +10°C to +35°C Storage: -10°C to +50°C
Humidity	Operating: 35% RH to 80% RH, no condensation Storage: 35% RH to 80% RH, no condensation
Vibration	Operating: 2.45 m/s <sup>2</sup> max. Storage: 4.9 m/s <sup>2</sup> max. Transportation: 14.7 m/s <sup>2</sup> max.
Ambient gases	There must be no corrosive gases present

Table 1.2 lists the acceptable operating environments.

**Table 1.2 Operating Environments**

<b>Item</b>	<b>Description</b>
Host computer	Built-in Pentium or higher-performance CPU (200 MHz or higher recommended); IBM PC or compatible machine with the PCMCIA TYPE II slot or the PCI slot.
OS	Windows <sup>®</sup> 98, Windows <sup>®</sup> Me, Windows NT <sup>®</sup> , Windows <sup>®</sup> 2000, or Windows <sup>®</sup> XP
Minimum memory capacity	32 Mbytes or more (double of the load module size recommended)
Hard-disk capacity	Installation disk capacity: 10 Mbytes or more. (Prepare an area at least double the memory capacity (four-times or more recommended) as the swap area.)
Pointing device such as mouse	Connectable to the host computer; compatible with Windows <sup>®</sup> 98, Windows <sup>®</sup> Me, Windows NT <sup>®</sup> , Windows <sup>®</sup> 2000, and Windows <sup>®</sup> XP.
Power voltage	5.0 ± 0.25 V
Current consumption	HS0005KCM05H: 60 mA (max) HS0005KCI05H: 55 mA (max)
CD-ROM drive	Required to install the emulator or refer to the emulator user's manual.

## **1.3 Components**

Check all the components unpacking. For details on the E10A emulator components, refer to section 6.1, Components of the Emulator. If the components are not complete, contact a Hitachi sales agency.

# Section 2 Preparation before Use

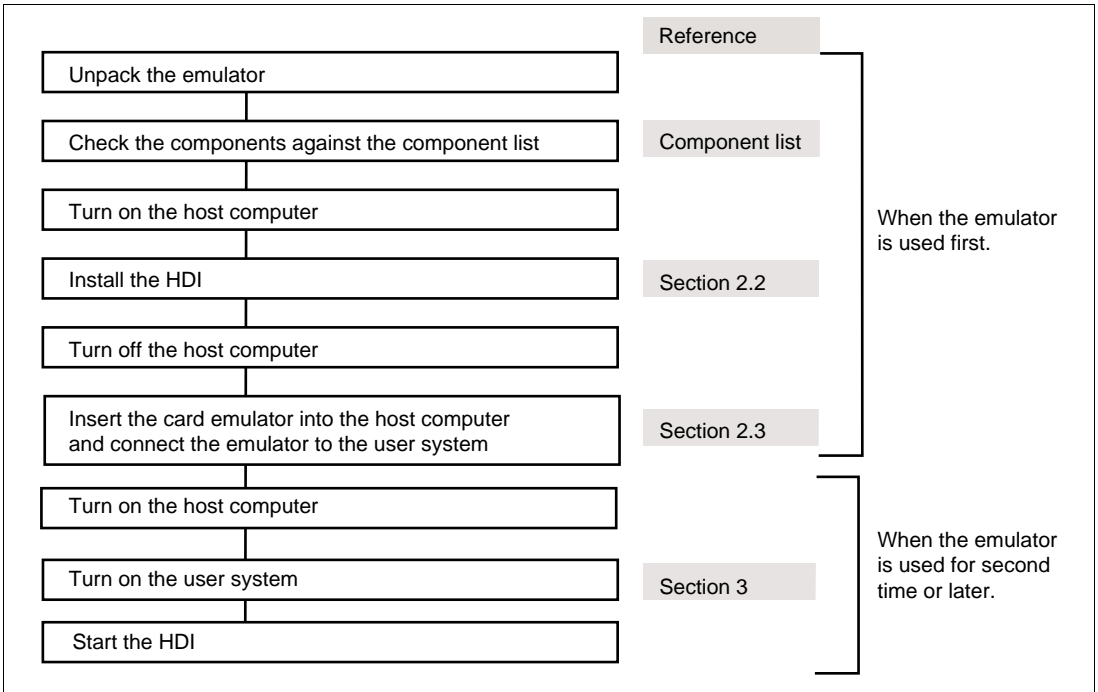
## 2.1 Emulator Preparation



# WARNING

**READ the reference sections shaded in figure 2.1 before using the emulator product. Incorrect operation will damage the user system and the emulator product. The USER PROGRAM will be LOST.**

Unpack the emulator and prepare it for use as follows:



**Figure 2.1 Emulator Preparation Flow Chart**

## 2.2 HDI Installation

When the CD-R is inserted in the host computer's CD-ROM drive, the HDI installation wizard is automatically activated (holding the Shift key down while the CD-R is inserted cancels this automatic activation). To run the installation wizard when it has not been automatically activated, execute Setup.exe from the root directory of the CD-R.

Follow the cues given by the installation wizard to install the HDI.

Since hardware settings are also made during installation, the installation procedure differs according to the operating system or interface (PCI or PCMCIA) being used. Follow the installation steps carefully according to the environment you are using.

### 2.2.1 Installing under Windows® 98 or Windows® Me Operating System

(1) When the emulator is a PCI card:

1. Install the HDI (when the component type has to be selected during installation, be sure to select [PCI Card Driver]).
2. Shut the operating system down and turn off the power to the host computer.
3. Insert the PCI-card emulator in a slot on the host computer. Refer to section 2.3, Connecting the Host Computer with the Card Emulator.
4. Restart the host computer. The hardware is now recognized and the driver is automatically installed.\*

(2) When the emulator is a PCMCIA card:

1. Install the HDI (when the component type has to be selected during installation, be sure to select [PC Card Driver (PCMCIA)]).
2. Insert the PCMCIA-card emulator in the host computer's slot. Refer to section 2.3, Connecting the Host Computer with the Card Emulator.
3. The hardware is now recognized and the driver is automatically installed.\*

Note: When [Add New Hardware Wizard] is displayed, select the [Search for the best driver for your device. (Recommended)] radio button and then the [Specify a location] check box to select the path to be searched for drivers. The location must be specified according to the emulator type, as indicated below:

When using the PCI-card emulator: <Drive>:\DRIVERS\PCI\95

When using the PCMCIA-card emulator: <Drive>:\DRIVERS\PCMCIA\95

(<Drive> is the CD-ROM drive name.)

## 2.2.2 Installing under Windows NT®4.0 Operating System

(1) When the emulator is a PCI card:

1. Shut the operating system down and turn off the power to the host computer.
2. Insert the PCI-card emulator in a slot on the host computer. Refer to section 2.3, Connecting the Host Computer with the Card Emulator.
3. Start the host computer and log-on with an administrator-level user name.
4. Install the HDI. (For a component, be sure to select [PCI Card Driver]. There is a check box for selecting the type name of the product under the [PCI Card Driver] component. Select the appropriate type name. If the correct name is not selected, the correct driver will not be installed, and the emulator will not operate.)
5. Restart the host computer.

(2) When the emulator is a PCMCIA card:

1. Shut the operating system down and turn off the power to the host computer.
2. Insert the PCMCIA-card emulator in the host computer's slot. Refer to section 2.3, Connecting the Host Computer with the Card Emulator.
3. Start the host computer and log-on with an administrator-level user name.
4. During HDI installation, the setting value should be checked beforehand because inquiries are made about the resource used by the PCMCIA-card emulator. Start the [Start] menu -> [Programs] -> [Administrative Tools (Common)] -> [Windows NT Diagnostics], check the status of the IRQ, I/O port, and memory from the resource panel, and determine the setting values that do not conflict with other devices. (The following resources are used: IRQ: one channel, I/O port: H'F byte, and memory: H'4000 byte.)
5. Install the HDI. (For a component, be sure to select [PC Card Driver (PCMCIA)]. There is a check box for selecting the type name of each product under the [PC Card Driver (PCMCIA)] component. Select the appropriate type name. If the correct name is not selected, the correct driver will not be installed and the emulator will not operate.)
6. Restart the host computer.

Note: The driver that has been selected in the [Drivers] component starts after the host computer is initiated. If the host computer is initiated with the card disconnected or with the incorrect driver installed, the driver cannot initiate and the service control manager informs the system of an error. This, however, is not a problem.

### 2.2.3 Installing under Windows® 2000 or Windows® XP Operating System

(1) When the emulator is a PCI card:

1. Log-on with an administrator-level user name.
2. Install the HDI. (When a component is selected, be sure to select [PCI Card Driver].)
3. Shut the operating system down and turn off the power to the host computer.
4. Insert the PCI-card emulator in a slot on the host computer. Refer to section 2.3, Connecting the Host Computer with the Card Emulator.
5. Restart the host computer and log-on with an administrator-level user name. The hardware is now recognized and the driver is automatically installed.\*

(2) When the emulator is a PCMCIA card:

1. Log-on with an administrator-level user name.
2. Install the HDI. (When a component is selected, be sure to select [PC Card Driver (PCMCIA)].)
3. Insert the PCMCIA-card emulator in the host computer's slot. Refer to section 2.3, Connecting the Host Computer with the Card Emulator.
4. The hardware is now recognized and the driver is automatically installed.\*

Note: When [Found New Hardware Wizard] is displayed, select the [Search for a suitable driver for my device (recommended).] radio button and then the [Specify a location] check box to select the path to be searched for drivers. The location must be specified according to the emulator type, as indicated below:

When using the PCI-card emulator: <Drive>:\DRIVERS\PCI\2000

When using the PCMCIA-card emulator: <Drive>:\DRIVERS\PCMCIA\2000

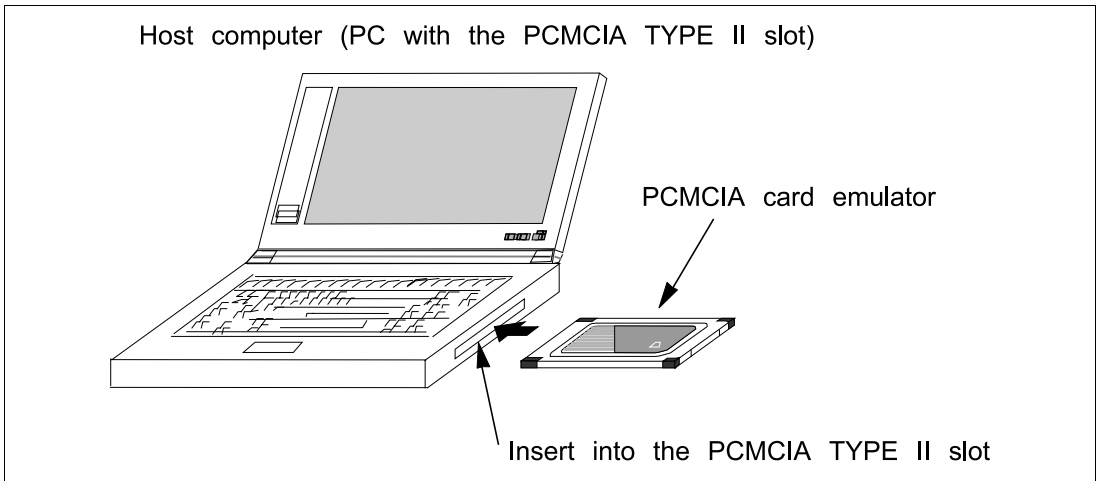
(<Drive> is the CD-ROM drive name.)



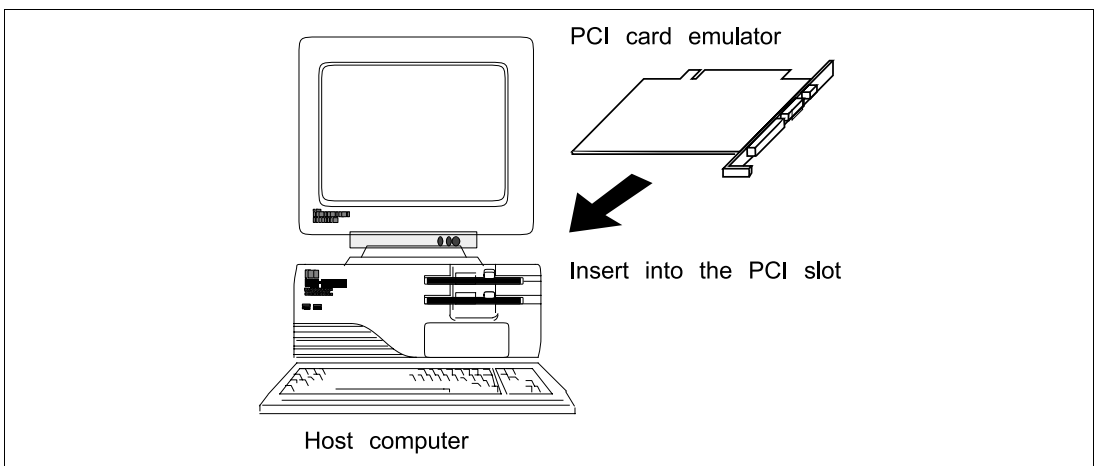
## 2.3 Connecting the Host Computer with the Card Emulator

Insert the card emulator into the PCMCIA TYPE II slot or the PCI slot of the host computer (figures 2.2 and 2.3).

**Note:** Be sure to install the HDI before the card emulator is inserted.



**Figure 2.2 Inserting the PCMCIA Card Emulator into the Host Computer**



**Figure 2.3 Inserting the PCI Card Emulator into the Host Computer**

Use the procedure, described in section 2.4, to connect the emulator to the user system with the user system interface cable, or to disconnect them when moving the emulator or the user system.

Note: When installing the PCI card emulator, note the following:

1. Turn off the host computer.
2. Insert the emulator into the PCI slot in parallel.
3. Screw in the emulator after confirming the connector and cable positions.

## 2.4 Connecting the Card Emulator with the User System

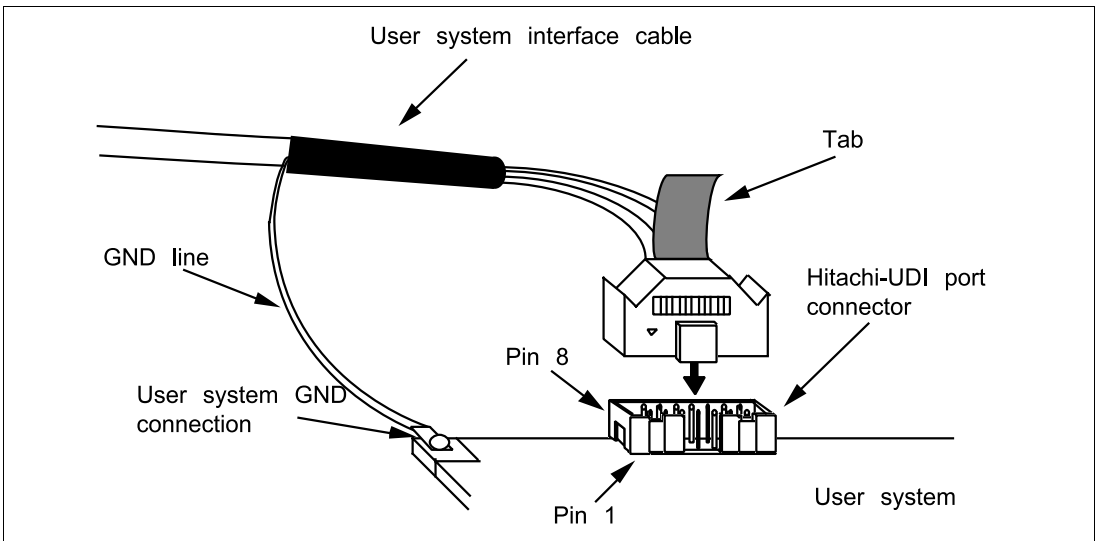
(1) The connector must be installed to the user system. Table 2.1 shows the recommended connector for the emulator.

**Table 2.1 Recommended Connector**

Type Number	Manufacturer	Specifications
2514-6002	3M Limited	14-pin straight type

**Note: When the connector is used, do not install any components within 3 mm of the connector.**

- (2) The pin arrangement of the connector is shown in section 6.2, Pin Arrangement of the Hitachi-UDI Port Connector.
- (3) Figure 2.4 shows how to connect the user system interface cable to the user system. Connect the ground line of the cable to the user system ground. The end of the ground line has a hole having a diameter of 3 mm, and therefore, when the ground line is screwed to the user system, the screw diameter must be 3 mm.



**Figure 2.4 Connecting the User System Interface Cable to the User System**

- Notes:**
- 1. To connect the signals output from the connector, refer to the MCU pin alignment.**
  - 2. To remove the user system interface cable from the user system, pull the tab on the connector upward.**
  - 3. The range of communications that the emulator operates at is different according to the MCUs used.**
  - 4. Connect the signals from the connector as shown in section 6.2, Pin Arrangement of the Hitachi-UDI Port Connector.**

## 2.5 System Check

When the HDI program is executed, check that the emulator operates correctly according to the following procedure:

1. Check that the card emulator is inserted into the host computer.
2. Connect the user system interface cable to the connector of the card emulator.
3. Connect the user system interface cable to the Hitachi-UDI port connector.
4. Power on the host computer and select [HDI for E10A H8Sxxxx] -> [Hitachi Debugging Interface] from the [Start] menu.

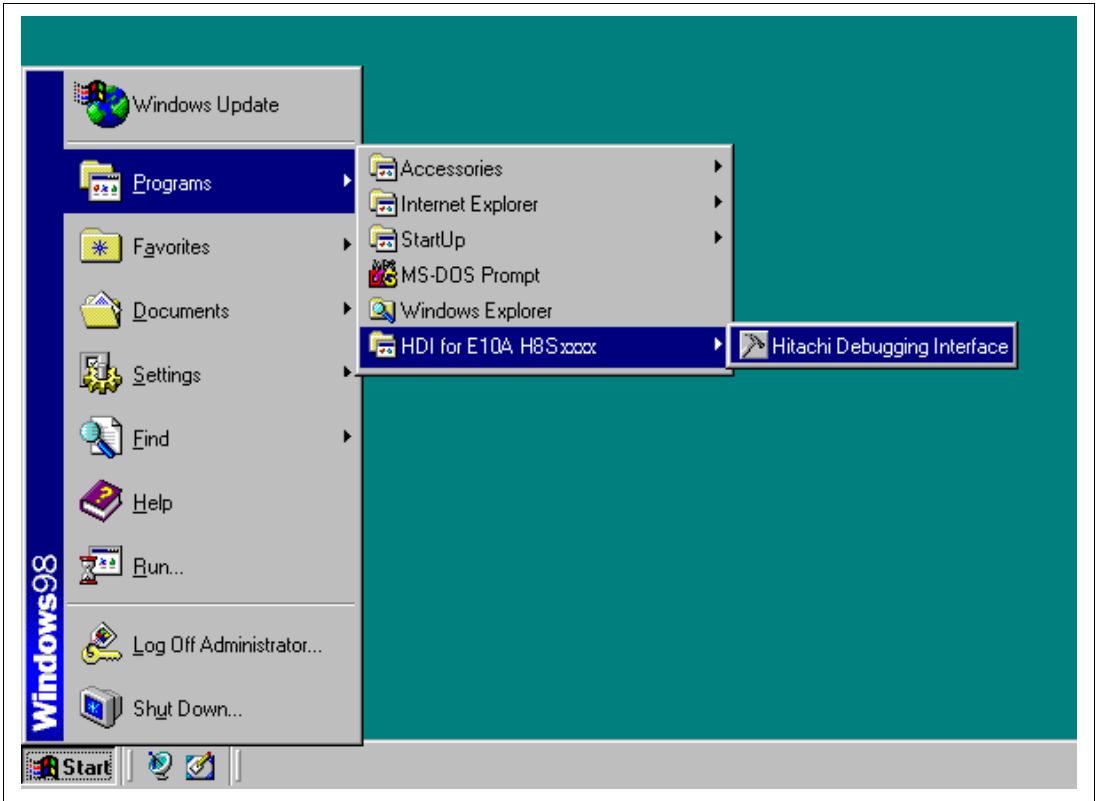
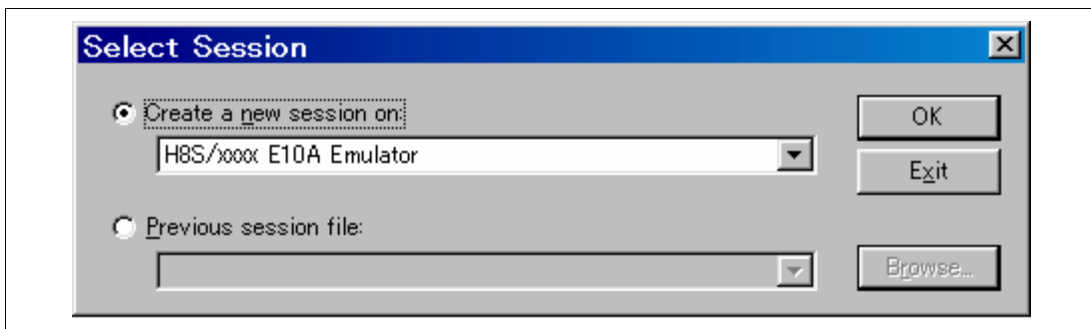


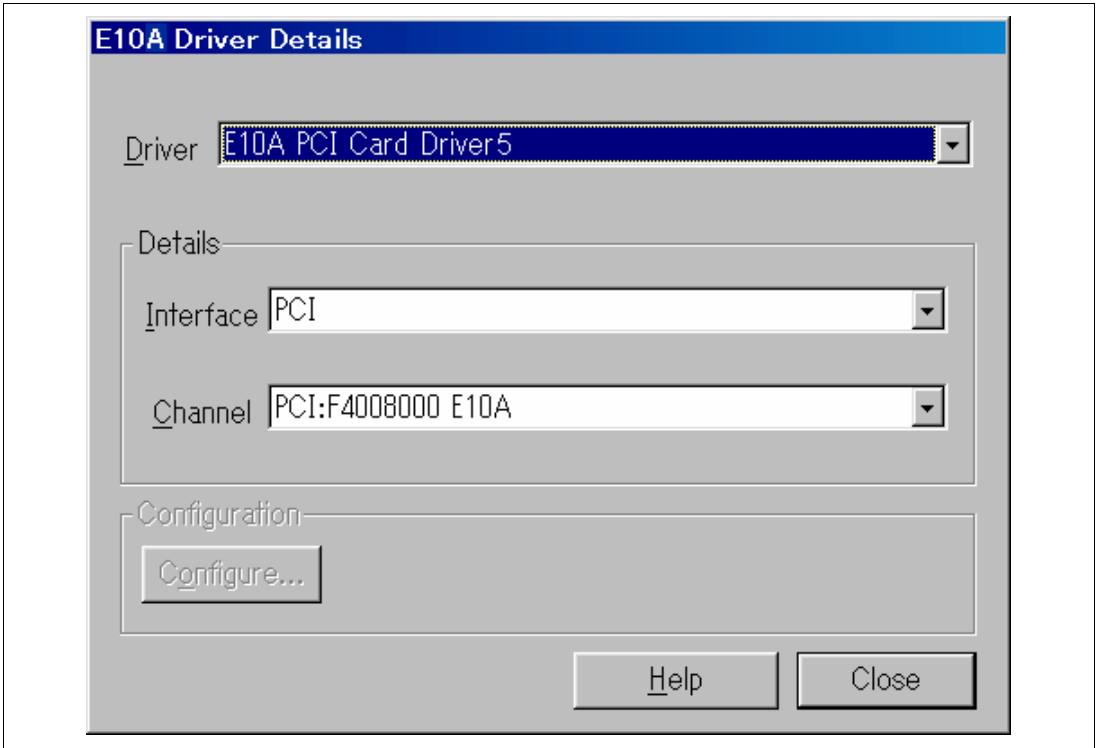
Figure 2.5 [Start] Menu

5. Power on the user system and select the setting to be used.



**Figure 2.6 [Select Session] Dialog Box**

- The [E10A Driver Details] dialog box is displayed. With the [Driver] combo box, select the driver to connect the HDI with the emulator. [Interface] displays the interface name of the PC interface board to be connected, and [Channel] displays the interface to which the board is connected. Once the driver is selected in the [E10A Driver Details] dialog box, this dialog box is not displayed when the HDI is run next time. (This procedure will not be executed by target MCUs.)



**Figure 2.7 [E10A Driver Details] Dialog Box**

- With the [Driver] combo box, select the driver to connect the HDI with the emulator.
- [Interface] displays the interface name of the card emulator to be connected, and [Channel] displays the interface to which the board is connected.

[Driver] combo box: Select [E10A PC Card Driver 5] to use the PCMCIA card emulator.  
Select [E10A PCI Card Driver 5] to use the PCI card emulator. For details, refer to table 6.3 in section 6.4.1, Emulator Driver Selection.

[Interface] combo box: Select [PC Card] to use the PCMCIA card emulator.  
Select [PCI] to use the PCI card emulator. (If the driver is not installed, the [PC Card] or [PCI] is not displayed.)

- Click the [Close] button.

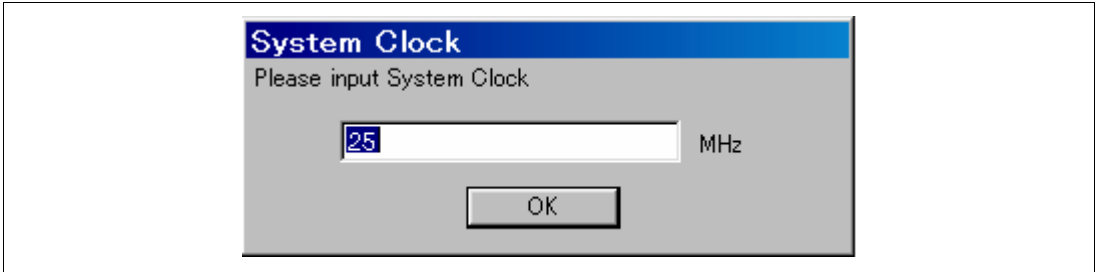
7. Supply power to the user system.

The subsequent procedures depend on the activation mode that was selected in step 5.

### 2.5.1 H8S/xxxx E10A Emulator Mode

This mode is used for debugging in the emulator.

1. After the [System Clock] window appears, input the system clock frequency. This frequency value is used when writing and erasing flash memory in the emulator.



**Figure 2.8 [System Clock] Dialog Box**

2. Set an eight-digit hexadecimal ID code as a security code for the flash memory. Input this ID code when [H8S/xxxx E10A Emulator] is selected and the [New registration] check box is unselected on activating the HDI. If the ID code is not matched, the flash memory contents are erased.



**Figure 2.9 [ID Code] Dialog Box**

3. When "Link up" appears on the status bar, the user and emulator programs have been downloaded to the flash memory, and the HDI initialization is complete.



**Figure 2.10 [HDI] Status Bar**

- Notes: 1. When the HDI is not linked up even if the above procedure has been executed, the driver will not be set correctly. Install drivers provided with the \SETUP directory in the CD-R according to the screen instructions.
2. If the user system interface cable is disconnected to the Hitachi-UDI port connector on the user system during user program execution, the following dialog box will be displayed.



Figure 2.11 [H-UDI Connector Disconnected] Dialog Box

3. If the emulator is not initiated, the following dialog boxes shown in figures 2.12 through 2.15 will be displayed.
- (a) If the following dialog box is displayed, the user system may not be turned on or the RESET signal may not have been correctly input to the MCU. Check the power supply and input circuit for the reset pin on the user system.

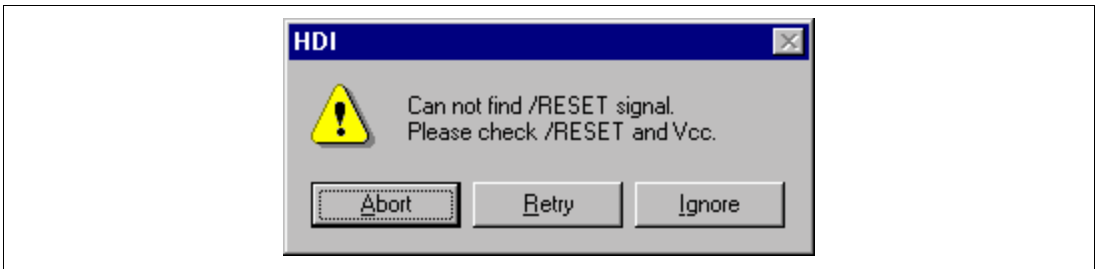
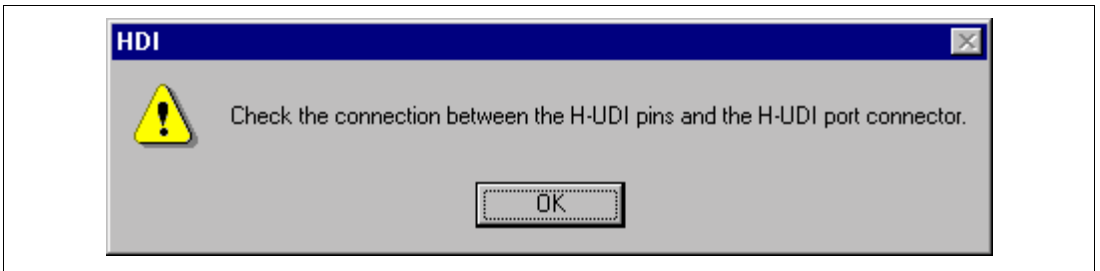


Figure 2.12 [Can not find /RESET signal] Dialog Box

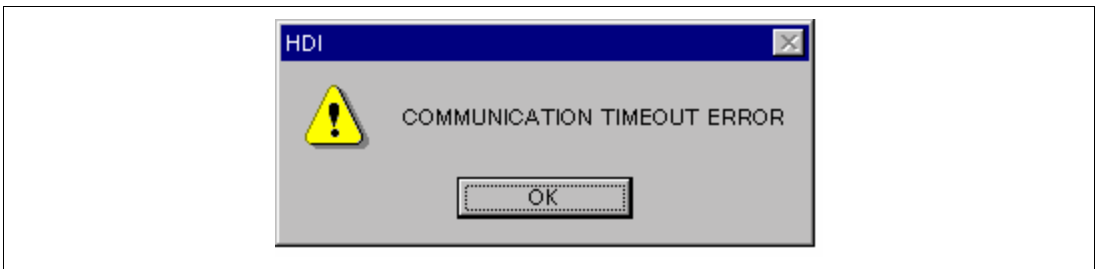


- (b) If the following dialog box is displayed, check that the Hitachi-UDI port connector on the user system is correctly connected.

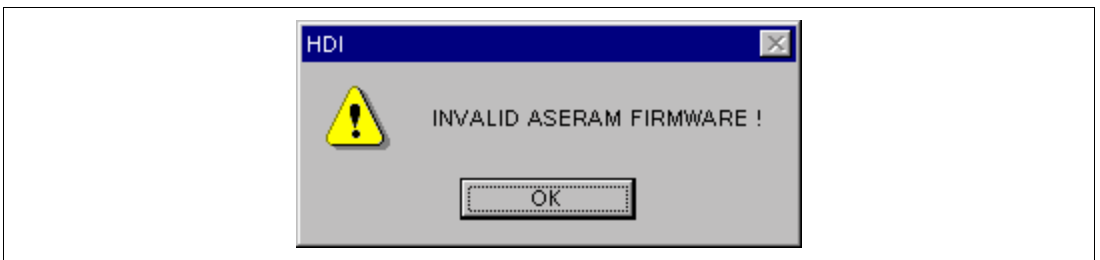


**Figure 2.13 [Check the connection] Dialog Box**

- (c) If the following dialog box is displayed, the MCU may not correctly operate. Check if there are reasons for illegal MCU operation.



**Figure 2.14 [COMMUNICATION TIMEOUT ERROR] Dialog Box**



**Figure 2.15 [INVALID ASERAM FIRMWARE!] Dialog Box**

4. If the driver is not correctly connected, the following dialog box will be displayed.

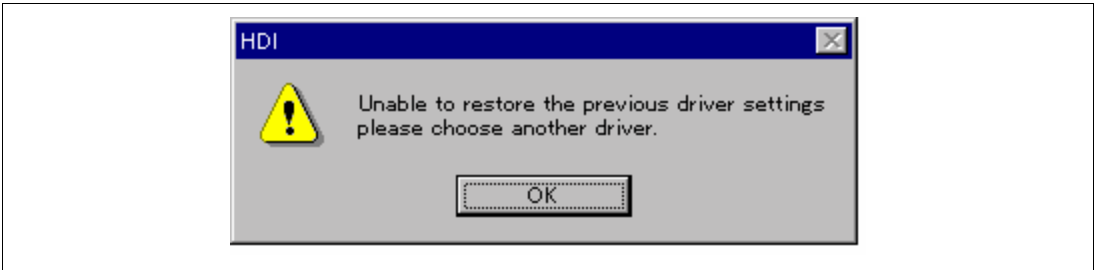


Figure 2.16 [Unable to restore the previous driver settings] Dialog Box

The [E10A Driver Details] dialog box is displayed when the [OK] button is clicked. Select the correct driver. For details, refer to section 6.4.1, Emulator Driver Selection.

### 2.5.2 Writing H8S/xxxx E10A Flash memory Mode

In this mode the emulator is used as a flash memory writer. The following procedures apply when [Writing H8S/xxxx E10A Flash memory] is selected from the activation modes listed in the [Select Session] dialog box.

1. After the [System Clock] window appears, input the system clock frequency.

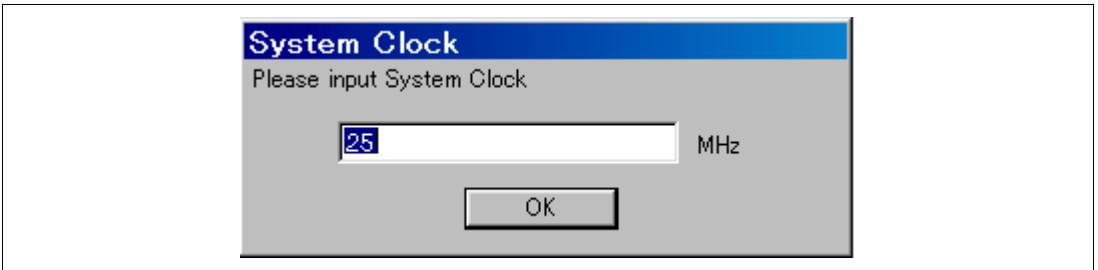
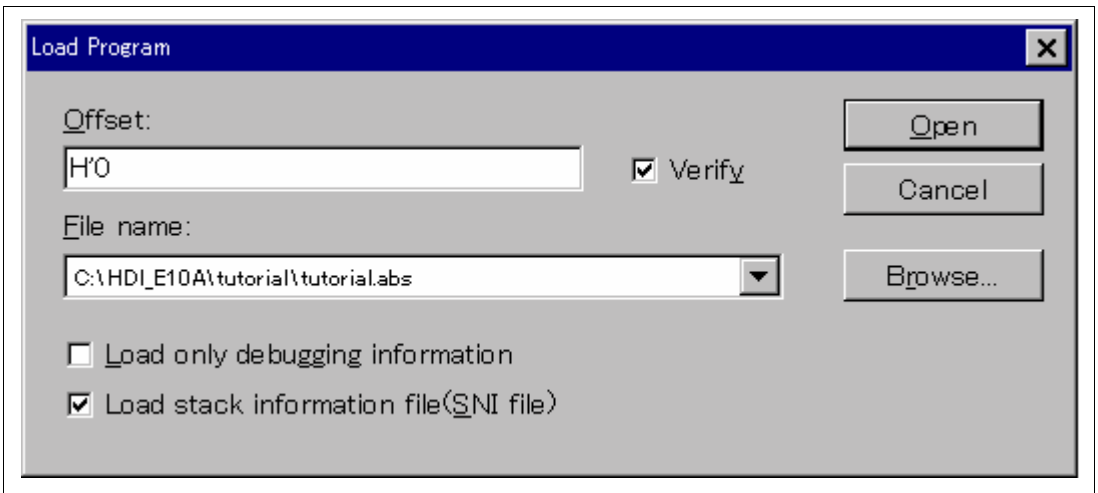


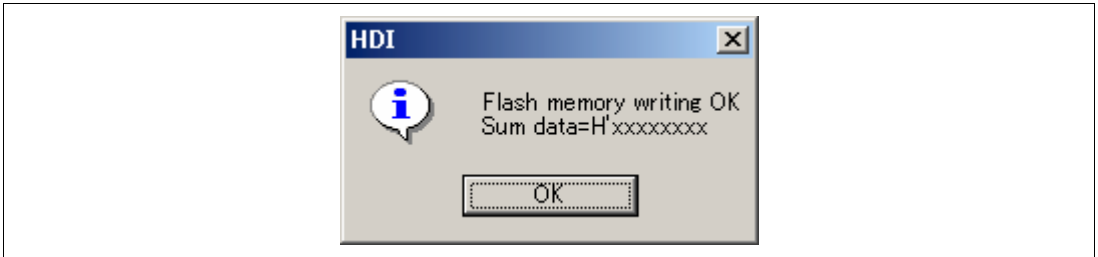
Figure 2.17 [System Clock] Dialog Box

- When the [Load Program] window appears, specify a user program to be downloaded. Click the [Open] button to start downloading.

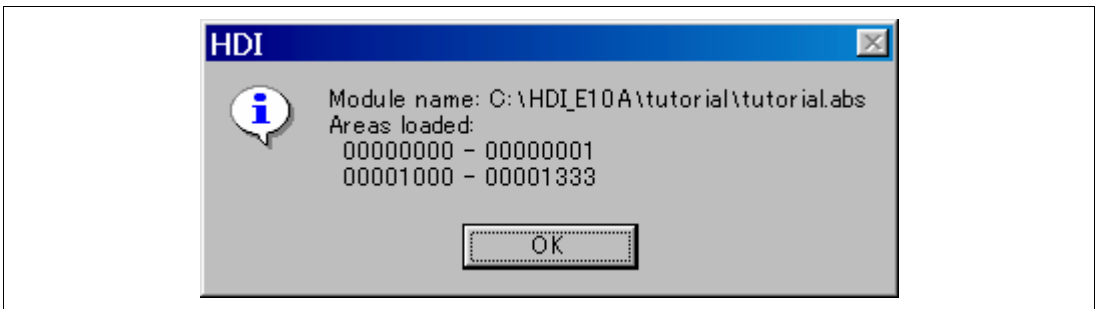


**Figure 2.18 [Load Program] Dialog Box**

- When the program has been downloaded, the memory area that the checksum value and the program code have been written appears.



**Figure 2.19 Checksum Value after Downloading the Program**



**Figure 2.20 [HDI] Dialog Box**

4. The [Continue] window appears. When the [OK] button is clicked, a message is displayed to request that power be supplied. Turn off the power, exchange the MCU, and supply power. Repeat operations 1 to 3 until the [Exit] button is clicked. When the [Exit] button is clicked, the HDI is terminated.

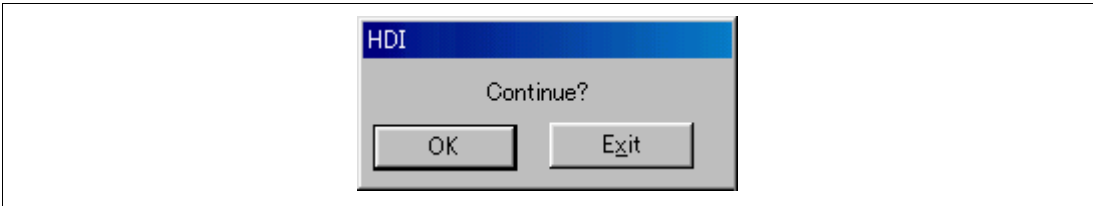


Figure 2.21 [Continue?] Window

- Notes:
1. When the HDI does not link up, and the above procedures have been executed, the driver setting must be incorrect. Install a driver from the \SETUP directory of the CD-R according to the screen instructions.
  2. If the user system interface cable is disconnected from the connector on the user system, the following dialog box will appear.

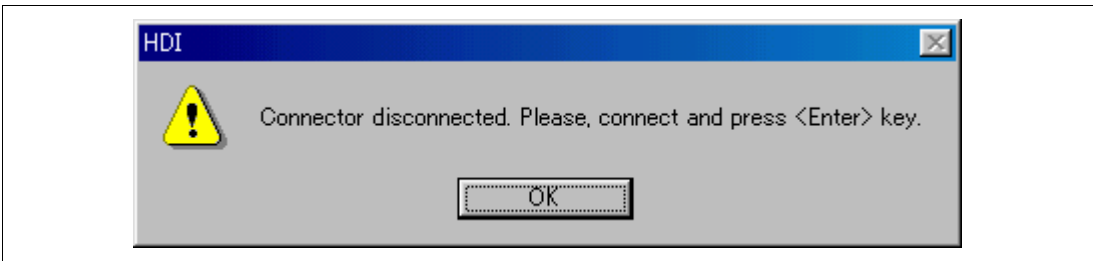


Figure 2.22 [Connector disconnected] Dialog Box

3. If the emulator is not properly initialized, the following dialog box will appear. If the following dialog box is displayed, the flash memory cannot be erased. Exchange the MCU since the flash memory has been rewritten to more times than the guaranteed value.

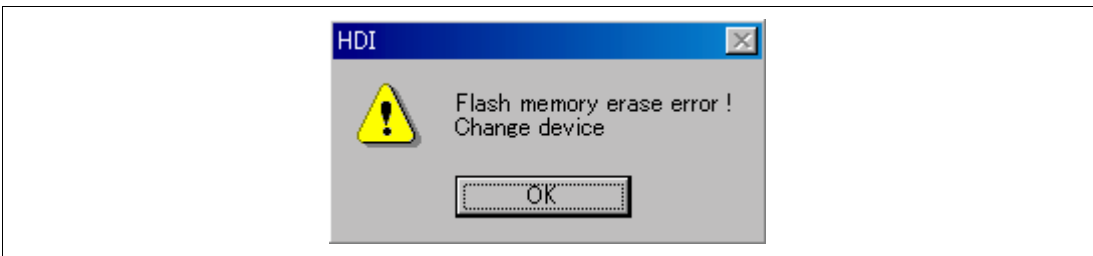


Figure 2.23 [Flash memory erase error!] Dialog Box

## 2.6 Ending the HDI

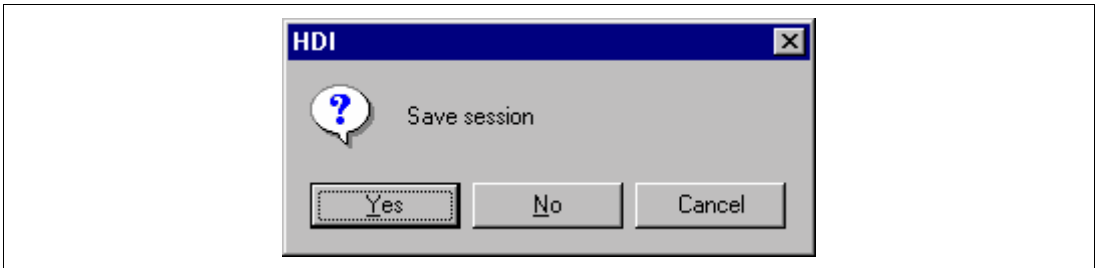
Power off the emulator by using the following procedure:

1. Select [Exit] from the [File] menu to end the HDI. When the [Exit HDI] dialog box is displayed, click the [Yes] button.



**Figure 2.24 [Exit HDI] Dialog Box**

2. Then, the [Save session] dialog box is displayed. If necessary, click the [Yes] button to save session. After saving session, the HDI ends. If not necessary, click the [No] button to end the HDI.



**Figure 2.25 [Save session] Dialog Box**

3. Turn the user system off.

## 2.7 Uninstalling the HDI

Follow this procedure to remove the installed HDI from the user's host computer.

1. Open [Add/Remove Programs Properties] from the control panel. Select the HDI program from the list and click the [Add/Remove...] button.
2. The setup program is executed again and the installed application can be changed, modified, or removed. When the application is to be uninstalled, select removal.

### **CAUTION**

**A shared file may be detected while the program is being removed. If another HDI may be using the shared file, do not remove the file. When Microsoft® Windows NT®4.0 operating system is used, the removal of the registry information on the driver may be asked. If other HDI may use the target driver, do not remove the registry information. If another HDI does not start up after the removal process, re-install that HDI.**

# Section 3 Tutorial

## 3.1 Introduction

The following describes the main functions of the emulator by using a tutorial program.

The tutorial program is based on the C program that sorts ten random data items in ascending or descending order. The tutorial program performs the following actions:

- The `main` function generates random data to be sorted.
- The `sort` function sorts the generated random data in ascending order.
- The `change` function then sorts the data in descending order.

The tutorial program is included in the `sort.c` file. The compiled load module is provided in the Sysrof format and is included in the `tutorial.abs` file.

Table 3.1 lists the tutorial program configuration.

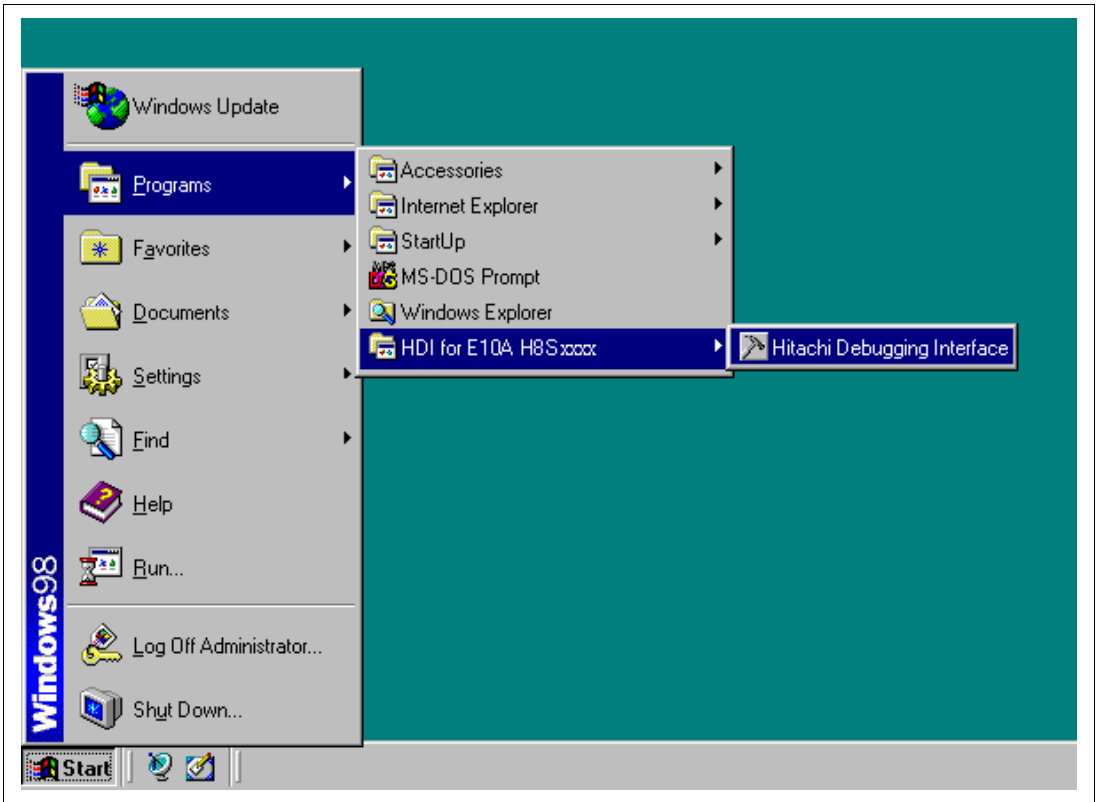
**Table 3.1 Tutorial Program: Configuration and Parts**

Item	Contents
Workspace for HEW V1.2	[Installation directory]\tutorial\tutorial.hws
Load module	[Installation directory]\tutorial\tutorial\Debug\tutorial.abs
Main program (source file)	[Installation directory]\tutorial\tutorial\tutorial.c
Stack information file	[Installation directory]\tutorial\tutorial\Debug\tutorial.sni

- Notes:**
1. This section describes general usage examples of the emulator. For each product specifications, refer to section 6 or on-line help.
  2. This program was created by using Hitachi Embedded Workshop (hereafter referred to as HEW) V1.2. Older versions of HEW will not open the workspace included with the package, so create a new workspace in such situations.
  3. This program was compiled without optimization. If recompiled with different settings, the addresses may differ from those given in this section.
  4. `tutorial.abs` is a load module in the Dwarf2 format. If a load module is recreated in the Sysrof format, the amount of information displayed on the HDI screen during the program's execution will be reduced.
  5. This section describes general usage examples for the emulator. For the specifications of particular products, refer to section 6 or the online help file.

## 3.2 Running the HDI

To run the HDI, select [HDI for E10A H8Sxxxx] -> [Hitachi Debugging Interface] from the [Start] menu.

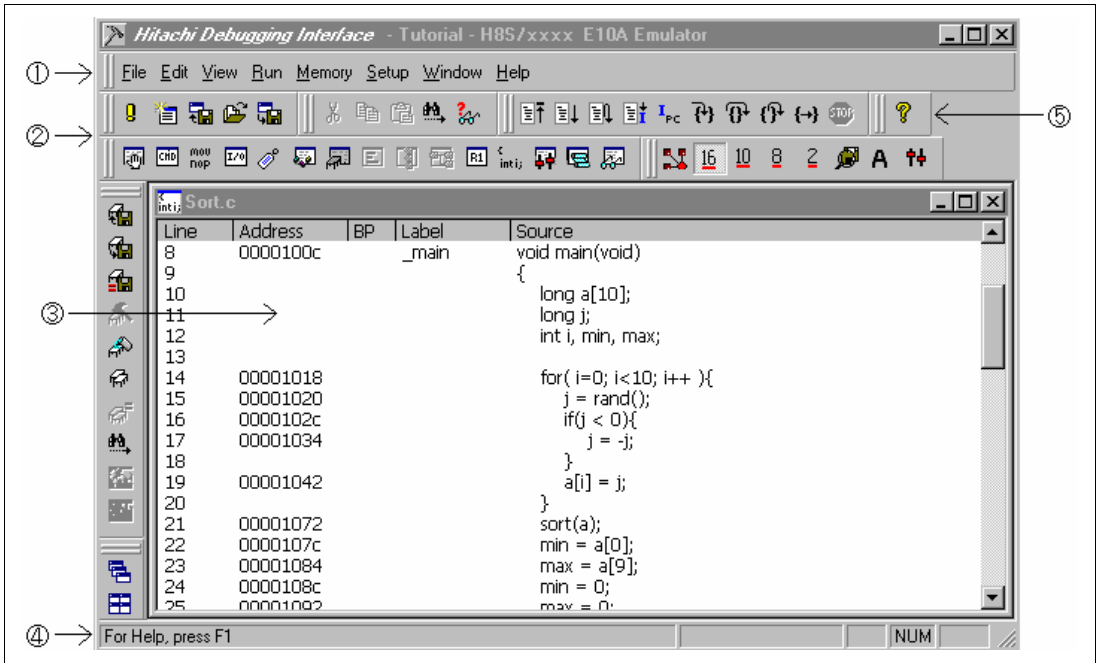


**Figure 3.1 [Start] Menu**

For the procedure of running the HDI, refer to section 2.5, System Check.



### 3.3 [HDI] Window



**Figure 3.2 [HDI] Window**

The key functions of the HDI are described in section 4, Descriptions of Windows. Numbers in figure 3.2 indicate the following:

1. Menu bar: Gives the user access to the HDI commands for using the HDI debugger.
2. Toolbar: Provides convenient buttons as shortcuts for the most frequently used menu commands.
3. Program window: Displays the source program being debugged.
4. Status bar: Displays the status of the emulator, and progress information about downloading.
5. [Help] button: Activates on-line help about any features of the HDI user interface.

### 3.4 Setting up the Emulator

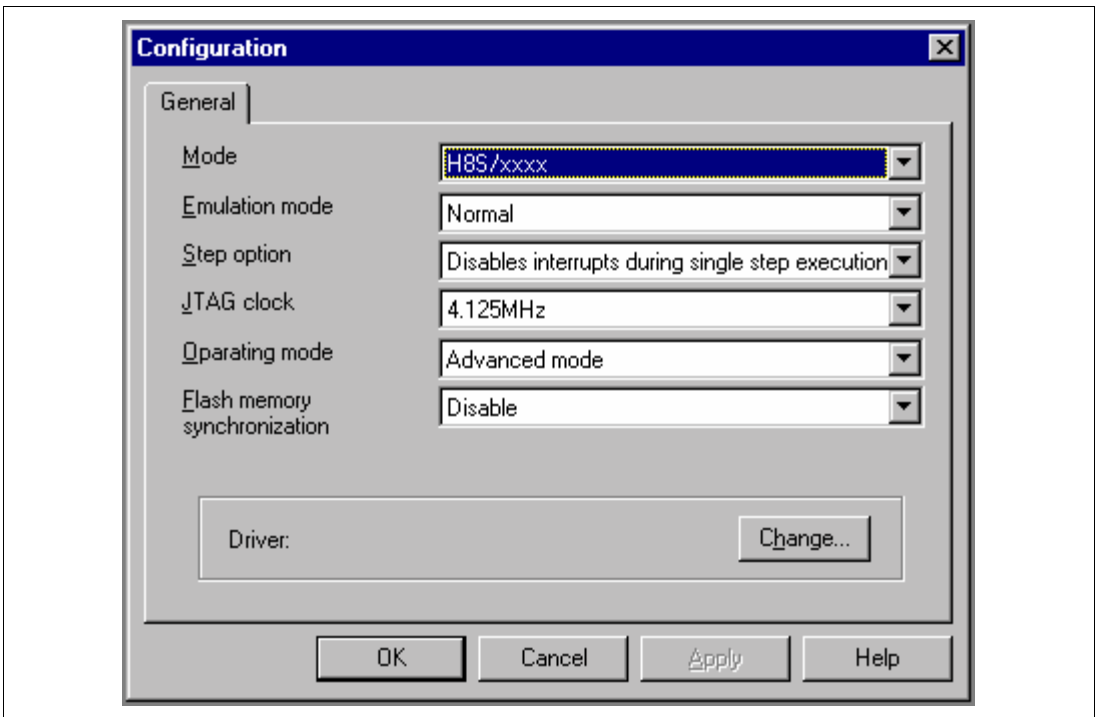
The following MCU conditions must be set up on the emulator before downloading the program:

- Device type
- Execution mode

The following describes how to set up the emulator for the tutorial programs.

### 3.5 Setting the [Configuration] Dialog Box

- Select [Configure Platform...] from the [Setup] menu to set configuration. The [Configuration] dialog box is displayed.



**Figure 3.3 [Configuration] Dialog Box**

**Note:** The items that can be set in this window differ according to the product. For the settings for each product, refer to the on-line help.

Set options as follows:

**Table 3.2 Setting the [Configuration] Dialog Box**

<b>Option</b>	<b>Value</b>
Mode	H8S/xxxx (default)
Emulation mode	Normal (normal execution, default)
Step option (Disables interrupt during single step execution)	Disables interrupts during single step execution (default)
JTAG clock	4.125 MHz (default)
Operating Mode	Operating mode determined by setting the mode pin (default)
Flash memory synchronization	Disable (default)

- Click the [OK] button to set any changes in the configuration.

## 3.6 Downloading the Tutorial Program

### 3.6.1 Downloading the Tutorial Program

Download the object program to be debugged.

- Select [Load Program...] from the [File] menu. The [Load Program] dialog box is displayed. Enter the [Offset] edit box and [File name] list box as shown in figure 3.4 and click the [Open] button.

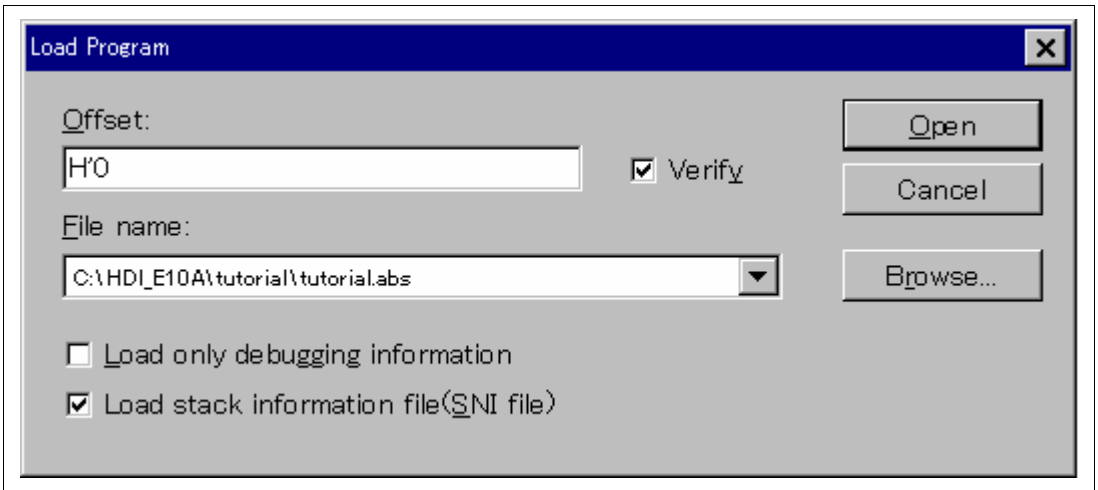


Figure 3.4 [Load Program] Dialog Box

When the file has been loaded, the following dialog box displays information about the memory areas that have been filled with the program code.

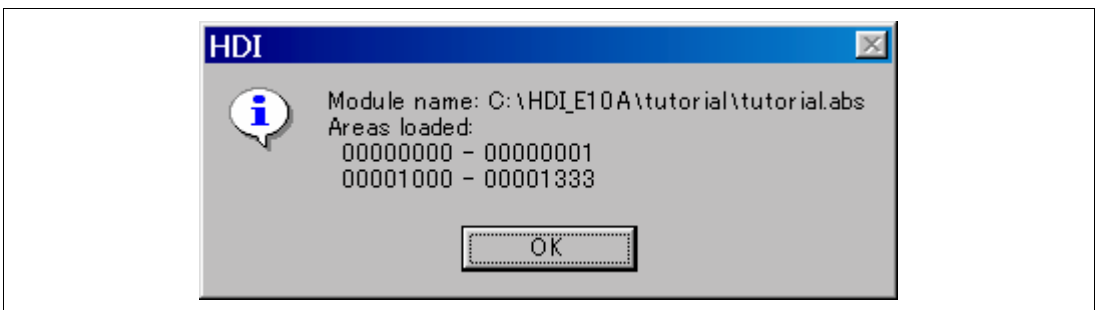


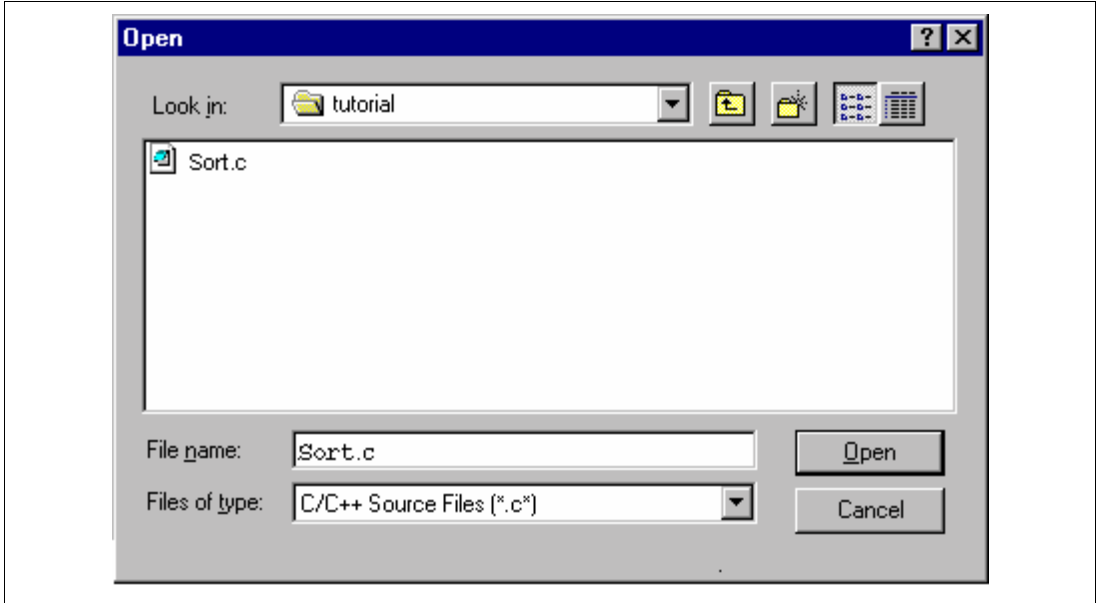
Figure 3.5 [HDI] Dialog Box

- Click the [OK] button to continue.

### 3.6.2 Displaying the Source Program

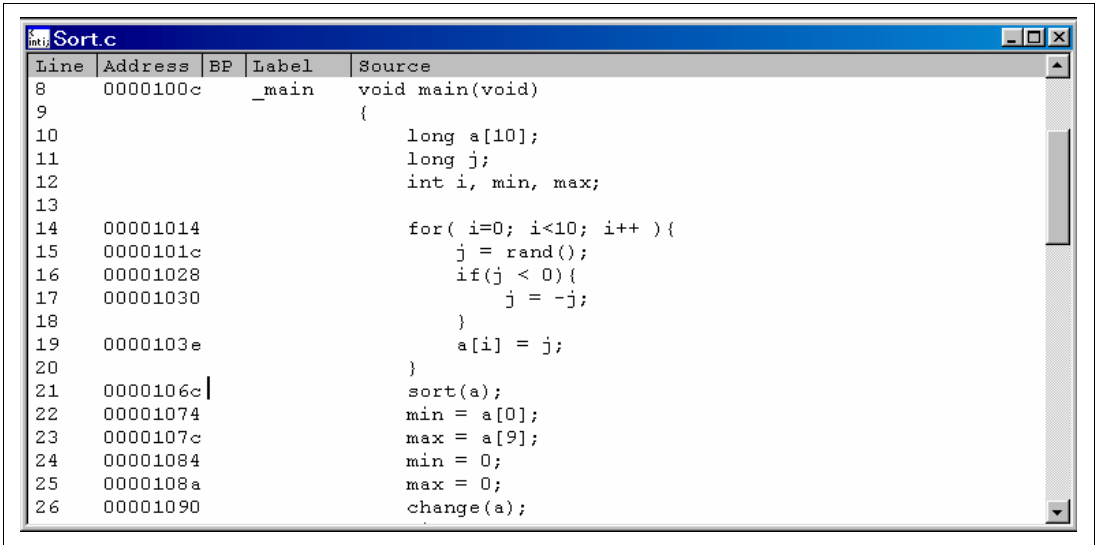
The HDI allows the user to debug a program at the source level.

- Select [Source...] from the [View] menu. The [Open] dialog box is displayed.
- Select the C source file that corresponds to the object file the user has loaded.



**Figure 3.6 [Open] Dialog Box**

- Select [Sort.c] and click the [Open] button. The [Program] window is displayed.



**Figure 3.7 [Program] Window (Displaying the Source Program)**

- If necessary, select the [Font...] option from the [Customize] submenu on the [Setup] menu to select a clear font and size.

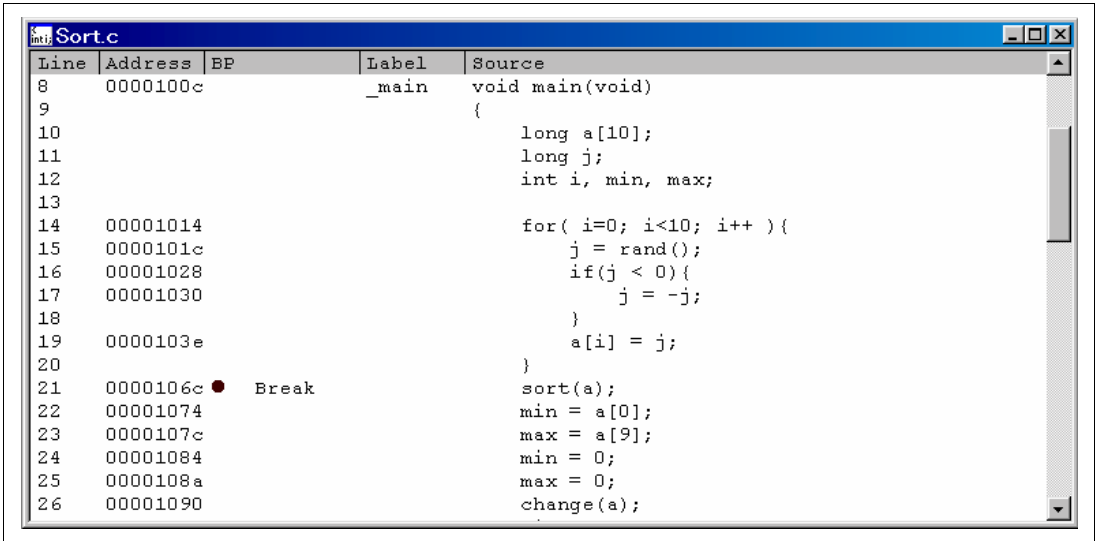
Initially the [Program] window shows the start of the main program, but the user can use the scroll bar to scroll through the program to see the other statements.

## 3.7 Setting the Software Breakpoint

A breakpoint is one of the easy debugging functions.

The [Program] window provides a very simple way of setting a software breakpoint at any point in a program. For example, to set a breakpoint at the `sort` function call:

- Select by double-clicking the [BP] column on the line containing the `sort` function call.



The screenshot shows a window titled "Sort.c" with a table of code lines. The table has four columns: Line, Address, BP, and Source. A red dot in the BP column of line 21 indicates a breakpoint is set. The source code for line 21 is `sort(a);`.

Line	Address	BP	Label	Source
8	0000100c		_main	void main(void)
9				{
10				long a[10];
11				long j;
12				int i, min, max;
13				
14	00001014			for( i=0; i<10; i++ ){
15	0000101c			j = rand();
16	00001028			if(j < 0){
17	00001030			j = -j;
18				}
19	0000103e			a[i] = j;
20				}
21	0000106c	● Break		sort(a);
22	00001074			min = a[0];
23	0000107c			max = a[9];
24	00001084			min = 0;
25	0000108a			max = 0;
26	00001090			change(a);

**Figure 3.8 [Program] Window (Setting a Software Breakpoint)**

The word [● Break] will be displayed on the line containing the `sort` function to show that a software breakpoint is set.

### 3.8 Setting Registers

Set values of the program counter and the stack pointer before executing the program.

- Select [Registers] from the [View] menu. The [Registers] window is displayed.

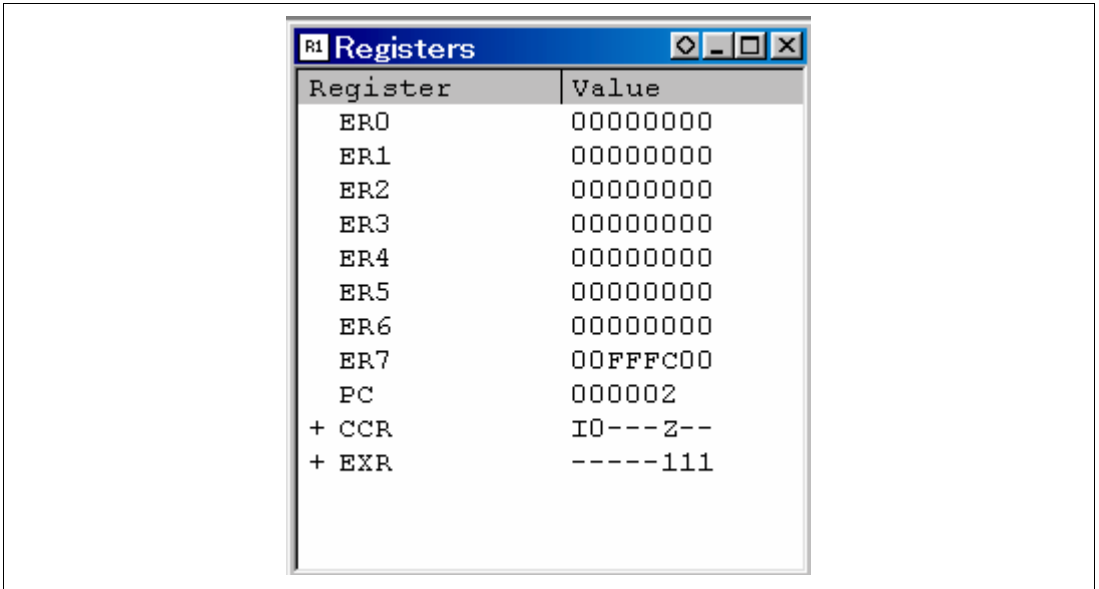


Figure 3.9 [Registers] Window

- To change the value of the program counter (PC), double-click the value area in the [Registers] window with the mouse. The following dialog box is then displayed, and the value can be changed.

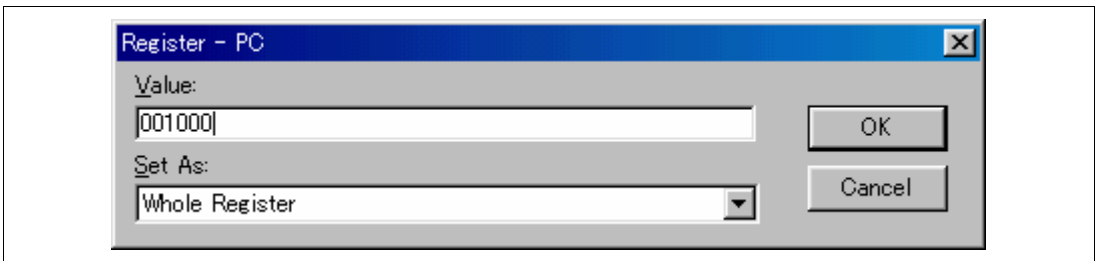
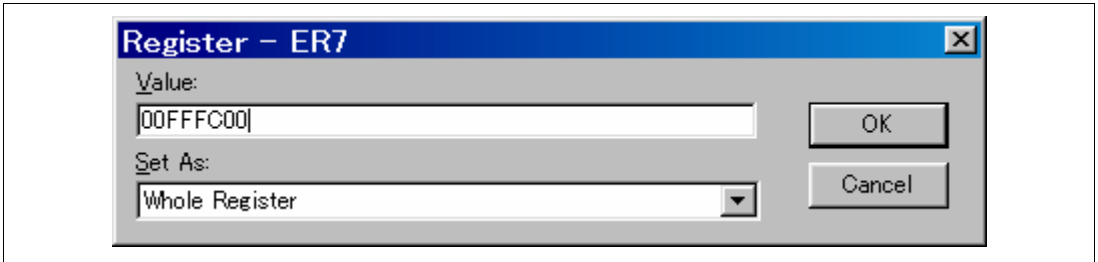


Figure 3.10 [Register] Dialog Box (PC)

- Set the program counter to H'1000 in this tutorial program, and click the [OK] button.
- To change the value of the stack pointer (SP), move the mouse pointer on the value to be changed in the [ER7] value area in the [Registers] window and enter the new value by the



keyboard, or double-click the value area with the mouse. The following dialog box is then displayed.



**Figure 3.11 [Register] Dialog Box (ER7)**

- Set the value of the stack pointer to H'FFFC00 in this tutorial program, and click the [OK] button.

## 3.9 Executing the Program

Execute the program as described in the following:

- To execute the program, select [Go] from the [Run] menu, or click the [Go] button on the toolbar.



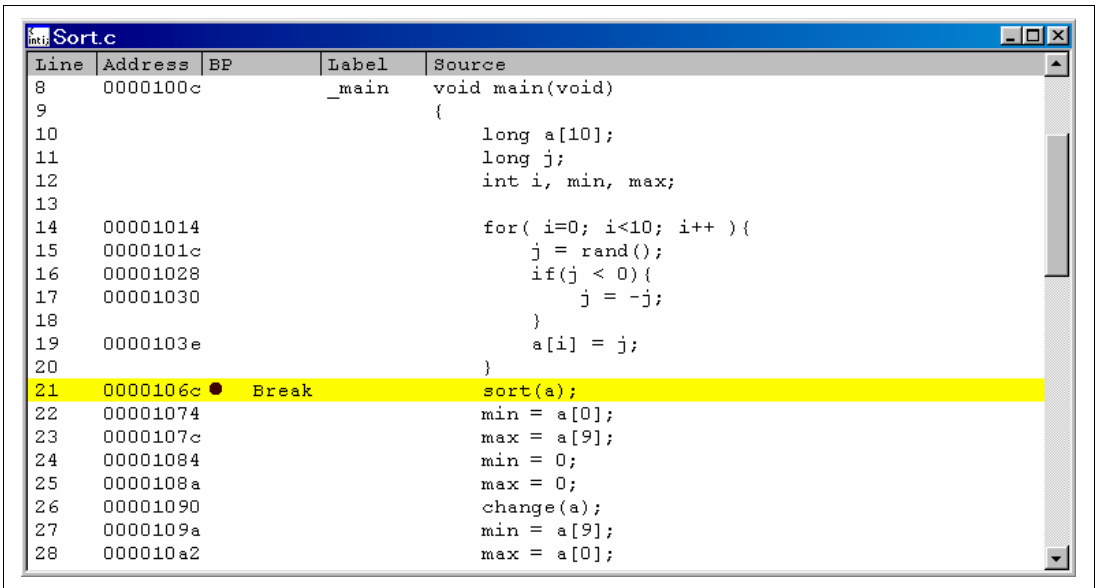
Figure 3.12 [Go] Button

- Or, select [Reset Go] from the [Run] menu or click the [Reset Go] button on the toolbar.



Figure 3.13 [Reset Go] Button

The program will be executed up to the breakpoint that has been inserted, and a statement will be highlighted in the [Program] window to show the position that the program has halted, with the message [Break=BREAKPOINT] in the status bar.

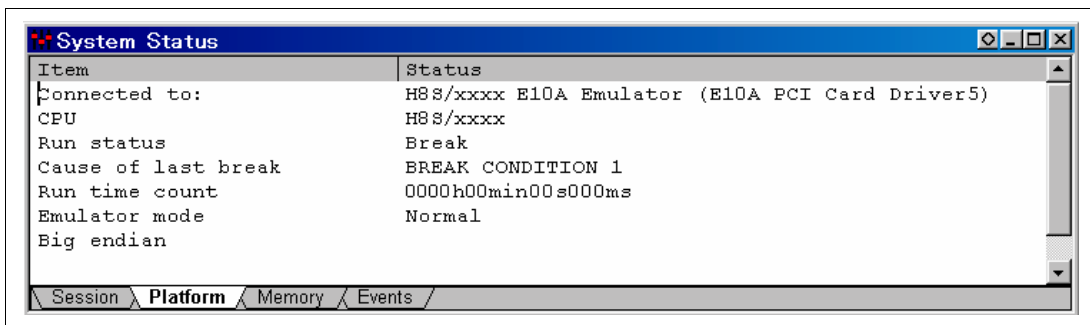


Line	Address	BP	Label	Source
8	0000100c		_main	void main(void)
9				{
10				long a[10];
11				long j;
12				int i, min, max;
13				
14	00001014			for( i=0; i<10; i++ ){
15	0000101c			j = rand();
16	00001028			if(j < 0){
17	00001030			j = -j;
18				}
19	0000103e			a[i] = j;
20				}
21	0000106c	● Break		sort(a);
22	00001074			min = a[0];
23	0000107c			max = a[9];
24	00001084			min = 0;
25	0000108a			max = 0;
26	00001090			change(a);
27	0000109a			min = a[9];
28	000010a2			max = a[0];

Figure 3.14 [Program] Window (Break Status)

The user can see the cause of the break that occurred last time in the [System Status] window.

- Select [Status] from the [View] menu. After the [System Status] window is displayed, open the [Platform] page, and check the status of Cause of last break.



**Figure 3.15 [System Status] Window**

**Note:** The items that can be displayed in this window differ according to the product. For the items that can be displayed, refer to the on-line help.

The [System Status] window displays the following items in each page.

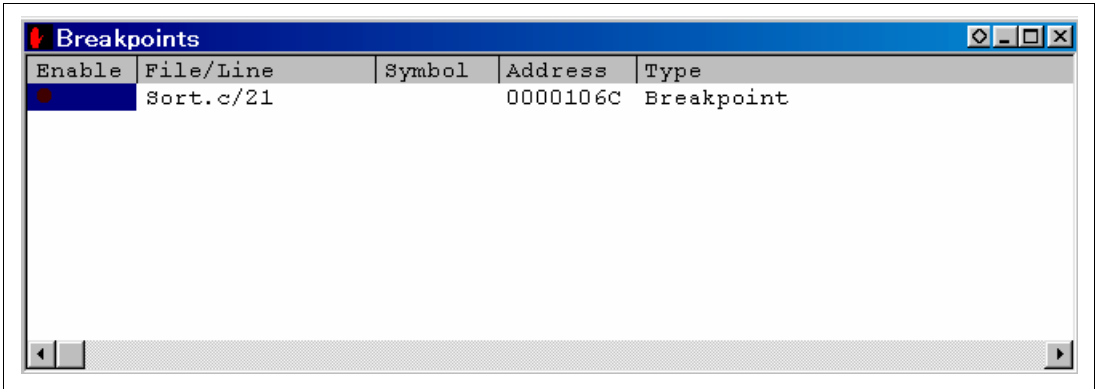
**Table 3.3 Contents of the [System Status] Window**

<b>Page</b>	<b>Item</b>	<b>Description</b>
[Session]	Target System	Always displays Connected.
	Session Name	Displays the session file name.
	Program Name	Displays the load module file name.
[Platform]	Connected To:	Displays the name of the connected emulator and the selected driver name.
	CPU	Displays the target MCU name.
	Run status	Displays the execution status: RUNNING: Being executed Break: Stopped
	Cause of last break	Displays the cause of the emulator stopping at break. In this example, the cause of the stop is BREAK POINT.
	Run time count	Displays the program execution time. The display format is h: hours, min: minutes, s: seconds, and ms: milliseconds. In this example, 0000h00min00s000ms is displayed.
	Emulator mode	Displays the emulator operating mode (setting information for [Emulation Mode] of the [Configuration] dialog box).
[Memory]	Loaded Memory Areas	Displays the loaded area of the load module.
[Events]	Resources	Displays the usage states of BREAKPOINT and Break Condition.

### 3.10 Reviewing Breakpoints

The user can see all the breakpoints set in the program in the [Breakpoints] window.

- Select [Breakpoints] from the [View] menu.



**Figure 3.16 [Breakpoints] Window**

The pop-up menu, opened by clicking the [Breakpoints] window with the right mouse button, also allows the user to set or change breakpoints, define new breakpoints, and delete, enable, or disable breakpoints.

### 3.11 Viewing Memory

The user can view the contents of a memory block in the [Memory] window. For example, to view the memory contents corresponding to the `main` in word size:

- Select [Memory ...] from the [View] menu, enter `main` in the [Address] edit box, and set word in the [Format] combo box.

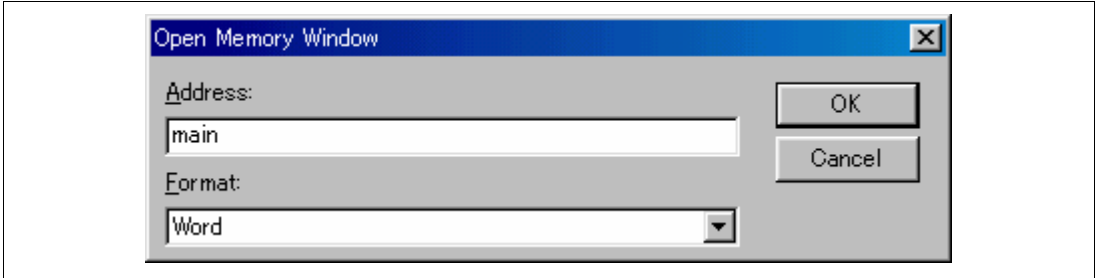


Figure 3.17 [Open Memory Window] Dialog Box

- Click the [OK] button. The [Memory] window showing the specified area of memory is displayed.

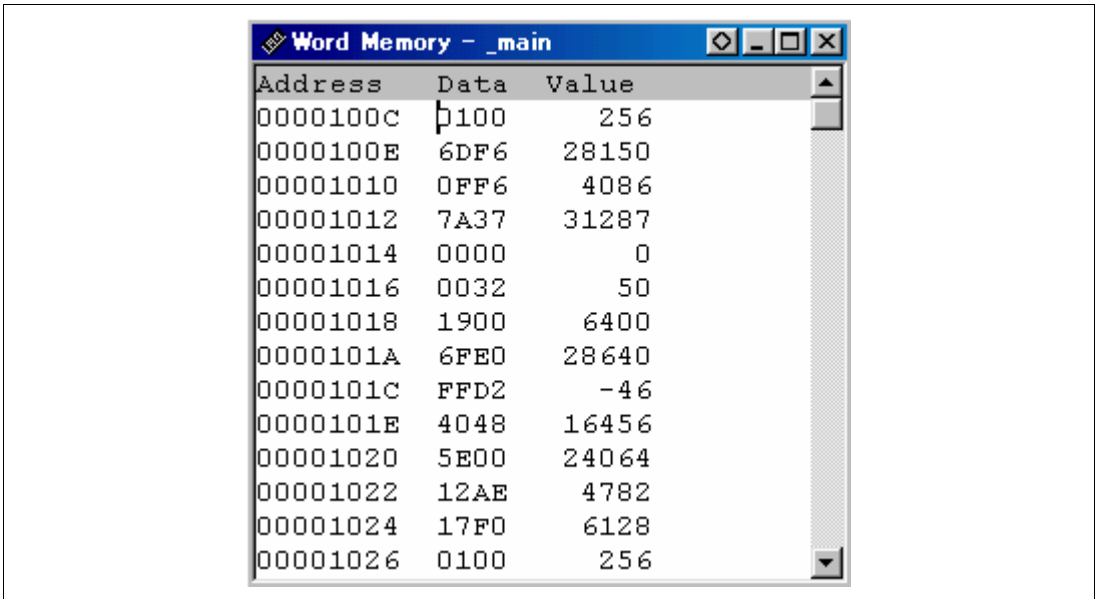


Figure 3.18 [Memory] Window

### 3.12 Watching Variables

As the user steps through a program, it is possible to watch that the values of variables used in the user program are changed. For example, set a watch on the long-type array `a` declared at the beginning of the program, by using the following procedure:

- Click the left of displayed array `a` in the [Program] window to position the cursor.
- Click the [Program] window with the right mouse button and select [Instant Watch...] from a pop-up menu.

The following dialog box will be displayed.



Figure 3.19 [Instant Watch] Dialog Box

- Click [Add Watch] button to add a variable to the [Watch] window.

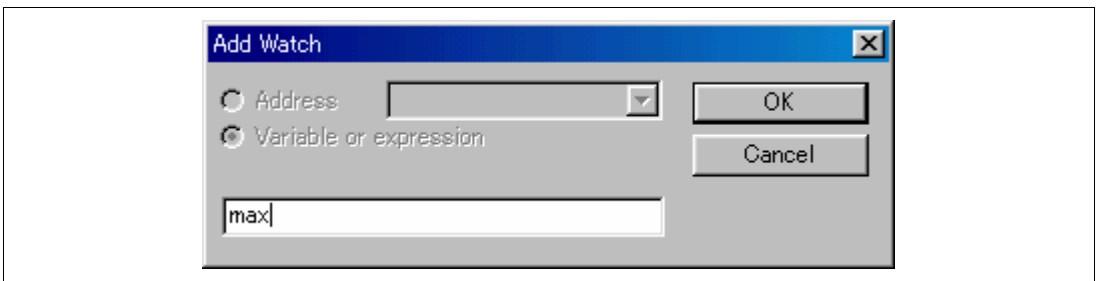


**Figure 3.20 [Watch] Window (Displaying the Array)**

The user can also add a variable to the [Watch] window by specifying its name.

- Click the [Watch] window with the right mouse button and select [Add Watch] from the pop-up menu.

The following dialog box will be displayed.

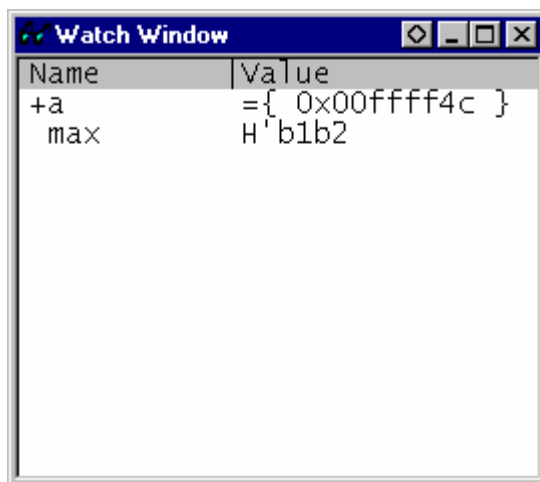


**Figure 3.21 [Add Watch] Dialog Box**

- Input variable *max* and click the [OK] button.

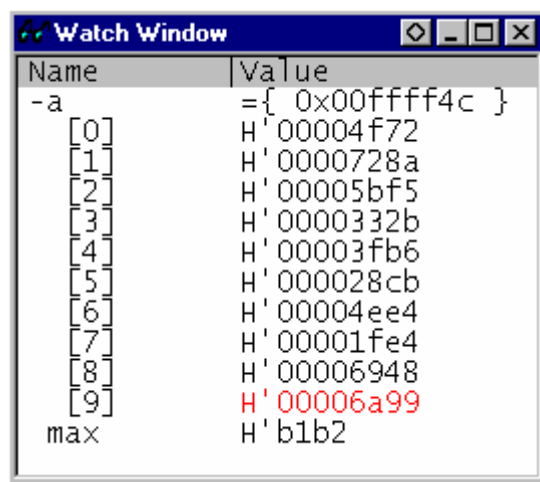


The [Watch] window will now also show the long-type variable max.



**Figure 3.22 [Watch] Window (Displaying the Variable)**

The user can double-click the + symbol to the left of any variable in the [Watch] window to watch the all elements in array a.



**Figure 3.23 [Watch] Window (Displaying Array Elements)**

### 3.13 Stepping Through a Program

The HDI provides a range of step menu commands that allow efficient program debugging.

**Table 3.4 Step Option**

<b>Menu Command</b>	<b>Description</b>
Step In	Executes each statement, including statements within functions.
Step Over	Executes a function call in a single step.
Step Out	Steps out of a function, and stops at the statement following the statement in the program that called the function.
Step...	Steps the specified times repeatedly at a specified rate.

### 3.13.1 Executing [Step In] Command

The [Step In] steps into the called function and stops at the first statement of the called function.

- To step through the `sort` function, select [Step In] from the [Run] menu, or click the [Step In] button in the toolbar.



Figure 3.24 [Step In] Button

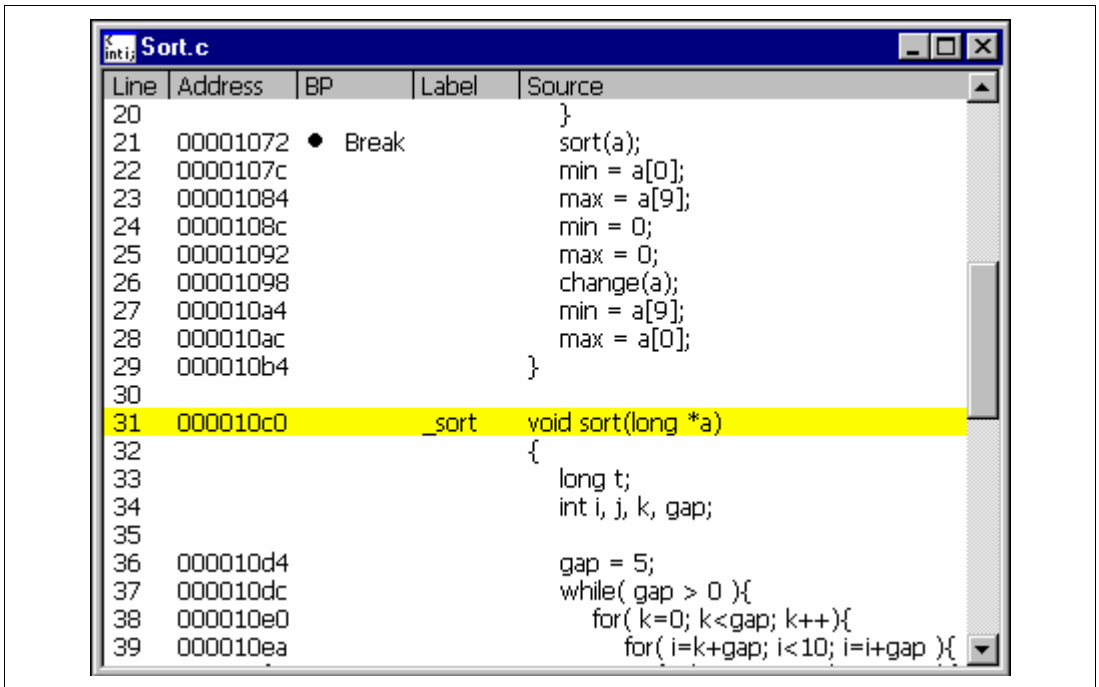


Figure 3.25 [Program] Window (Step In)

- The highlighted line moves to the first statement of the `sort` function in the [Program] window.

### 3.13.2 Executing [Step Out] Command

The [Step Out] steps out of the called function and stops at the next statement of the calling statement in the main function.

- To step out of the `sort` function, select [Step Out] from the [Run] menu, or click the [Step Out] button in the toolbar.



Figure 3.26 [Step Out] Button

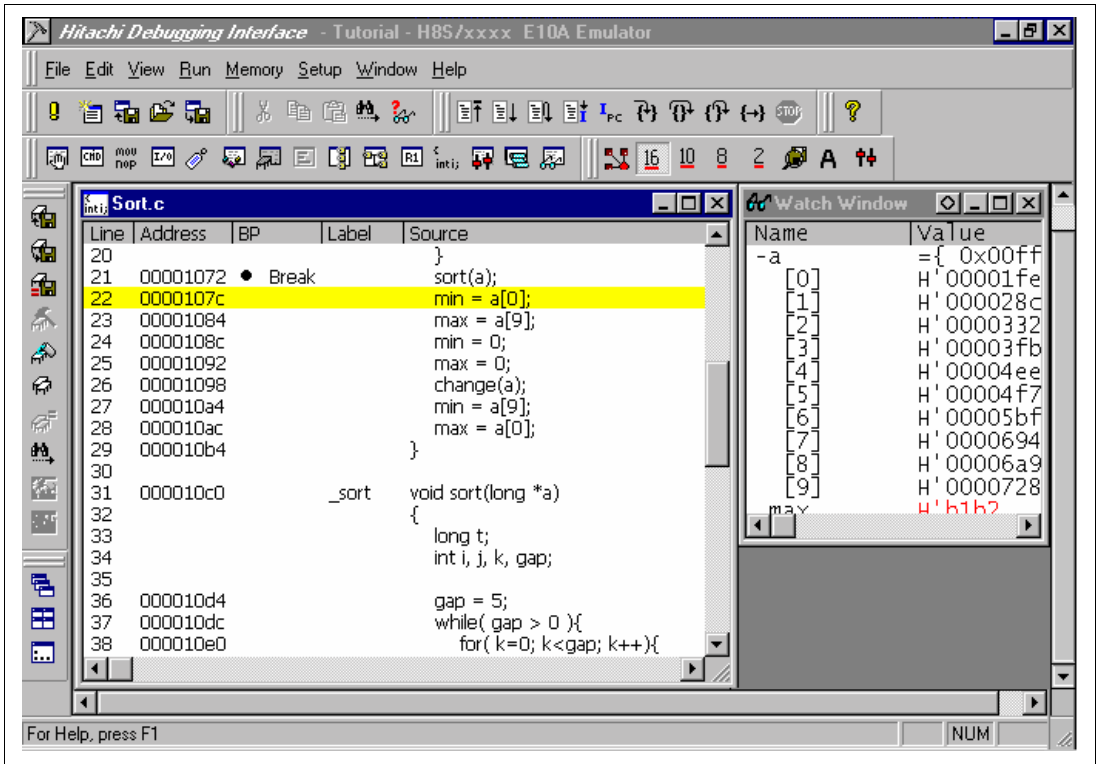
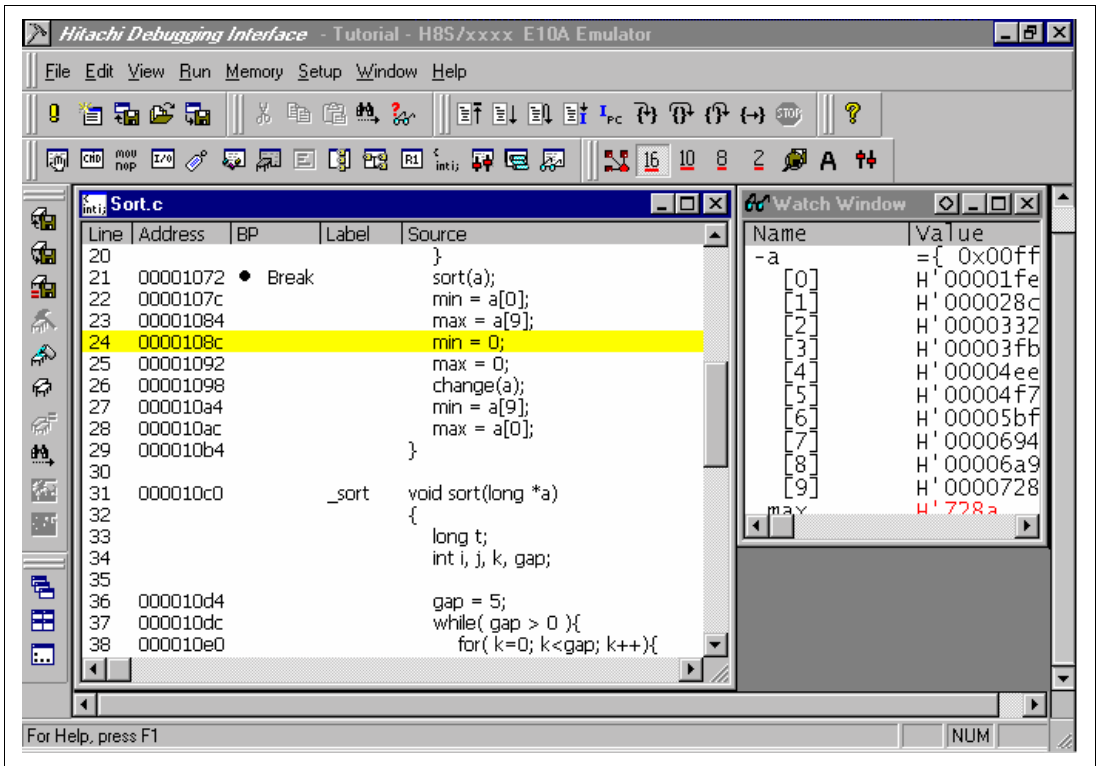


Figure 3.27 [Program] Window (Step Out)

- The data of variable `a` displayed in the [Watch] window is sorted in ascending order.

- To execute two steps, use [Step In] twice.



**Figure 3.28 [Program] Window (Step In → Step In)**

- The value of max displayed in the [Watch] window is changed to the maximum data value.

### 3.13.3 Executing [Step Over] Command

The [Step Over] executes a function call as a single step and stops at the next statement of the main program.

- Using [Step Over], execute two steps to reach the change function statement.

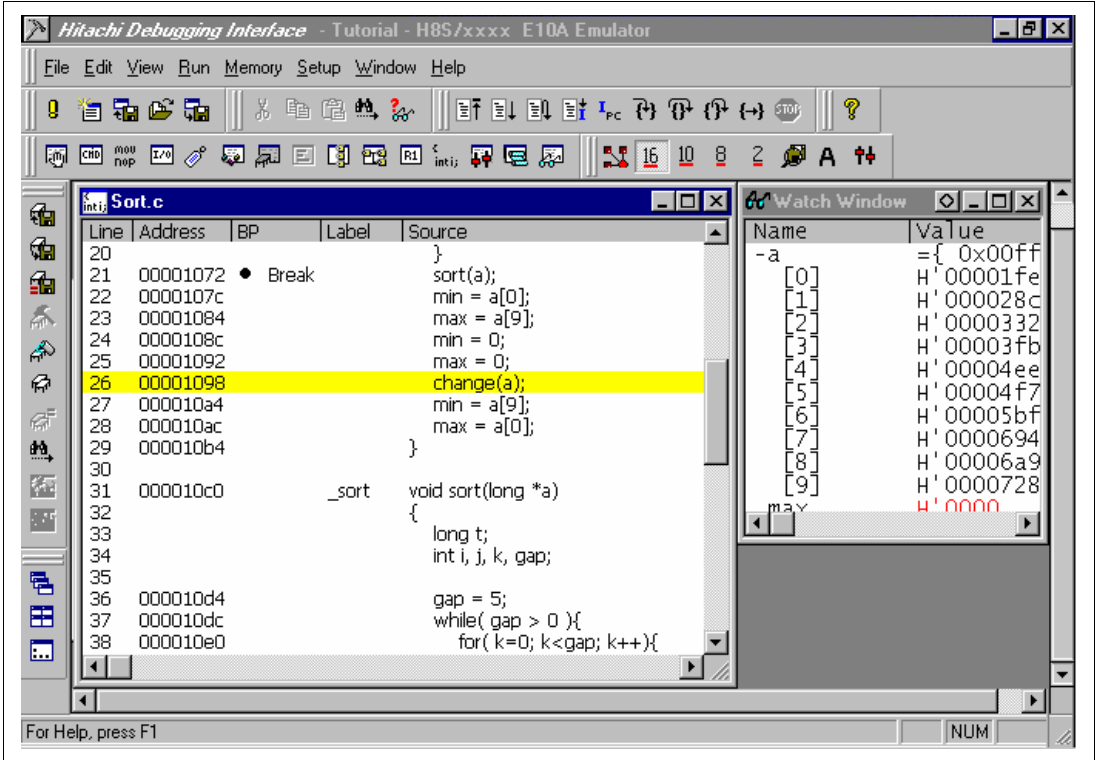
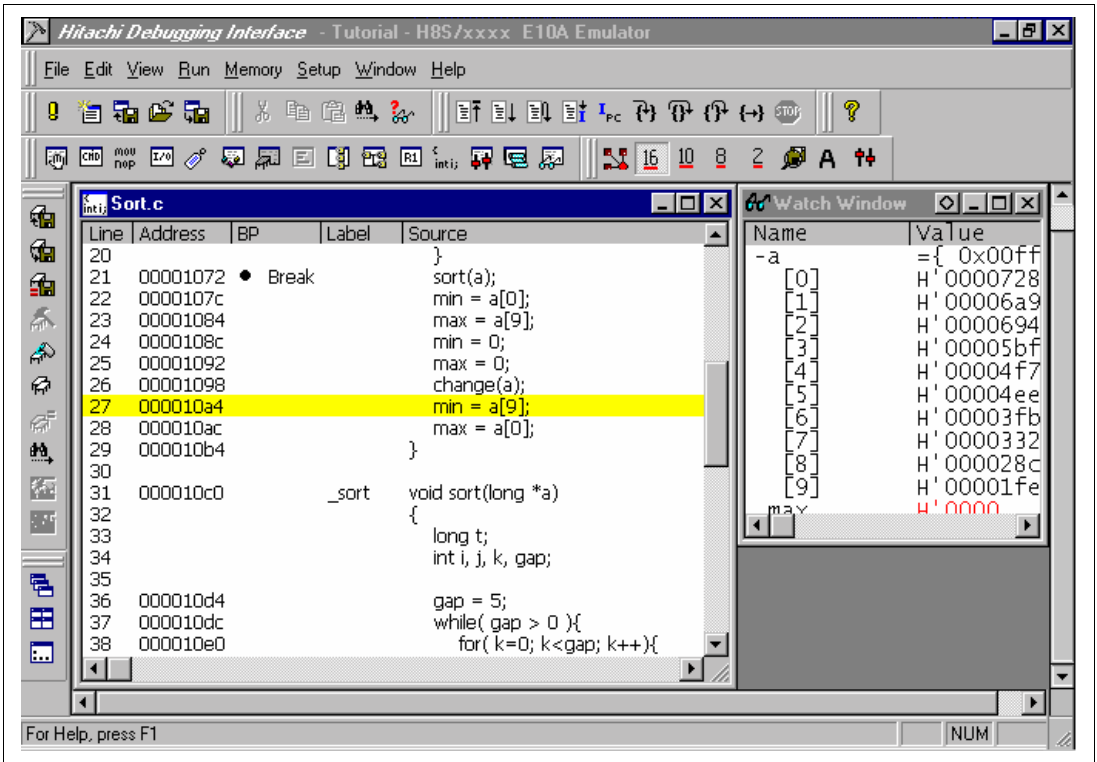


Figure 3.29 [Program] Window (Before Step Over Execution)

- To step through all statements in the change function at a single step, select [Step Over] from the [Run] menu, or click the [Step Over] button in the toolbar.



Figure 3.30 [Step Over] Button



**Figure 3.31 [Program] Window (Step Over)**

When the last statement of the change function is executed, the data of variable a, which is displayed in the [Watch] window, is sorted in descending order.

### 3.14 Displaying Local Variables

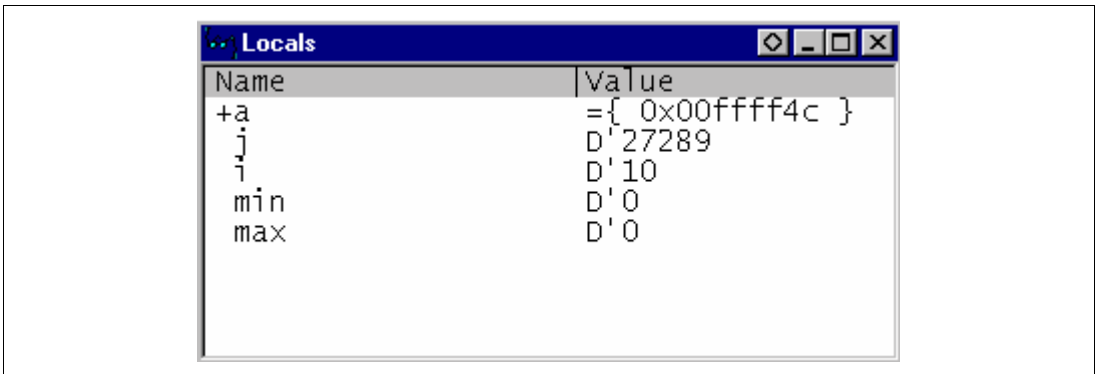
The user can display local variables in a function using the [Locals] window. For example, we will examine the local variables in the `main` function, which declares five local variables: `a`, `j`, `i`, `min`, and `max`.

- Select [Locals] from the [View] menu. The [Locals] window is displayed.

Initially, the [Locals] window is empty because local variables have not yet been declared.

- Select [Step In] from the [Run] menu to execute a single step.

The [Locals] window will now show the local variables and their values.



**Figure 3.32 [Locals] Window**

- Double-click the + symbol in front of array `a` in the [Locals] window to display the elements of array `a`.
- Refer to the elements of array `a` before and after the execution of the `sort` function, and confirm that random data is sorted in descending order.



## 3.15 Break Function

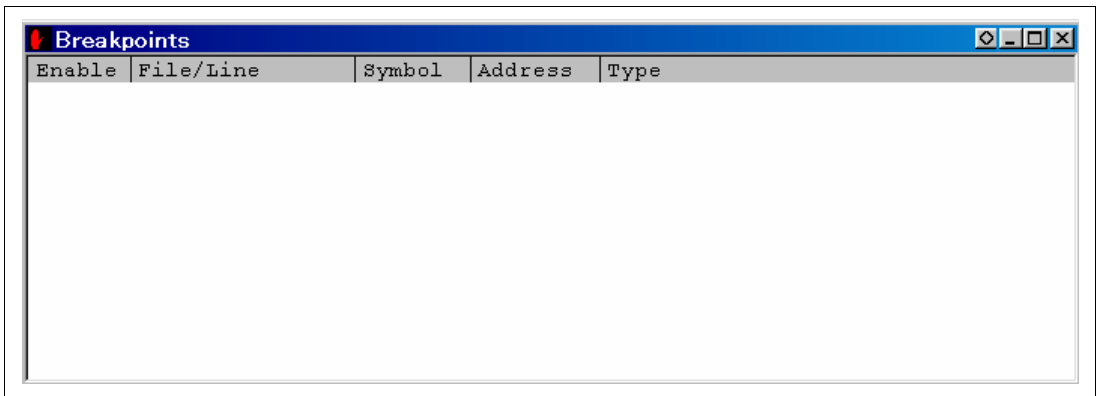
The emulator has software and hardware break functions. With the HDI, a software breakpoint can be set using the [Breakpoints] window, and a hardware break condition can be set using the [Break condition 1] dialog box.

An overview and setting of the break function are described below.

### 3.15.1 Software Break Function

The emulator can set up to 255 software breakpoints. Setting a software breakpoint is described below.

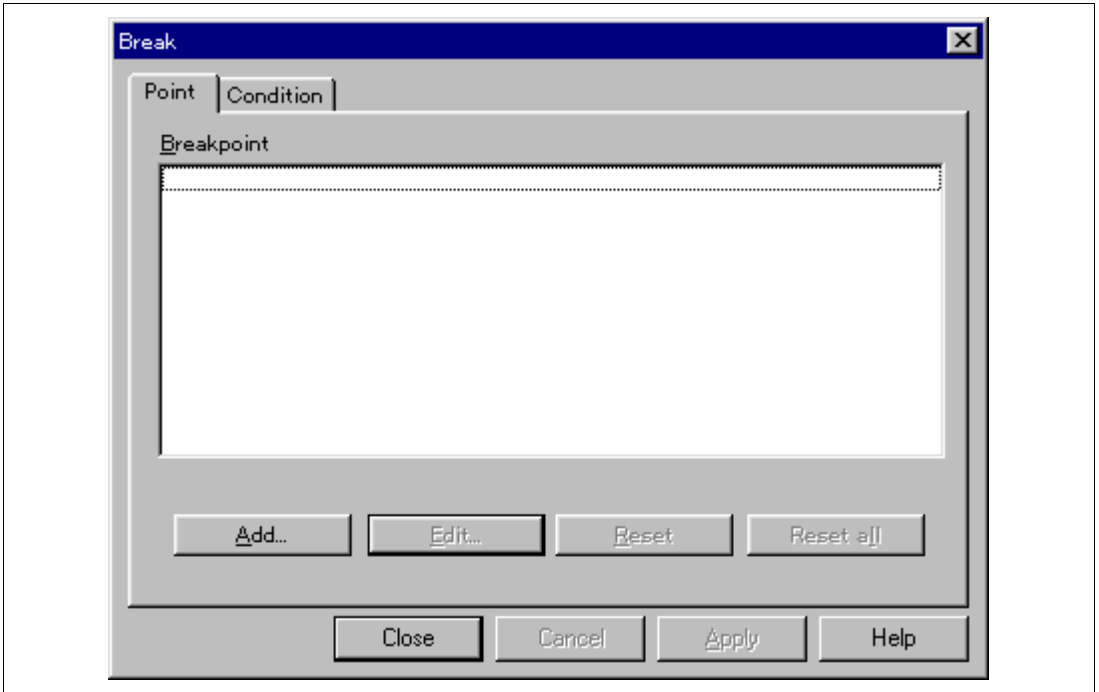
- Select [Breakpoints] from the [View] menu. The [Breakpoints] window is displayed.
- Click the [Breakpoints] window with the right mouse button and select [Delete All] from the pop-up menu to cancel all the breakpoints that have been set.



**Figure 3.33 [Breakpoints] Window (Before Software Breakpoint Setting)**

- Click the [Breakpoints] window with the right mouse button and select [Add] from the pop-up menu.

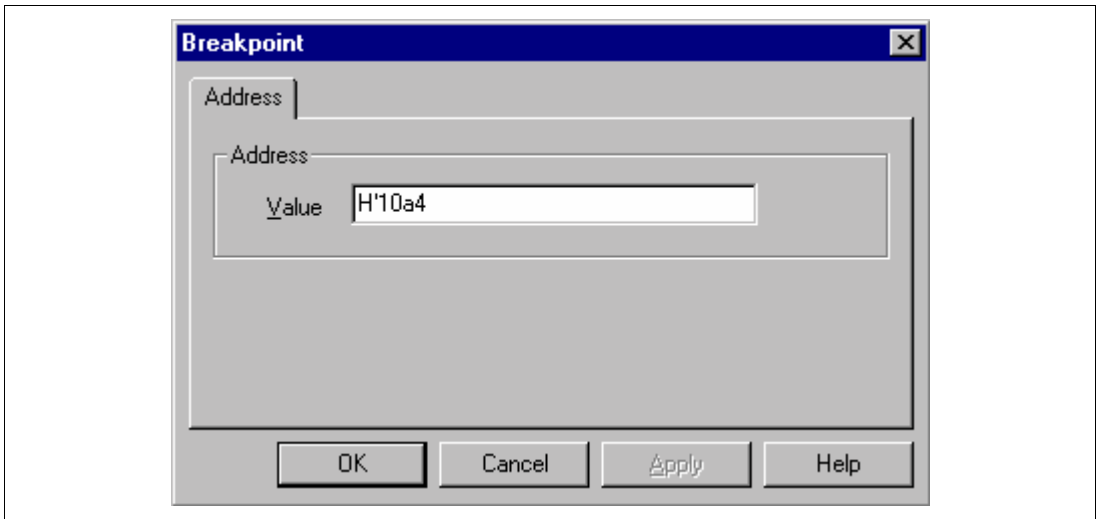
The [Break] dialog box is displayed. The [Point] page is displayed as a default.



**Figure 3.34 [Point] Page ([Break] Dialog Box)**

- Click the [Add...] button to display the [Breakpoint] dialog box.

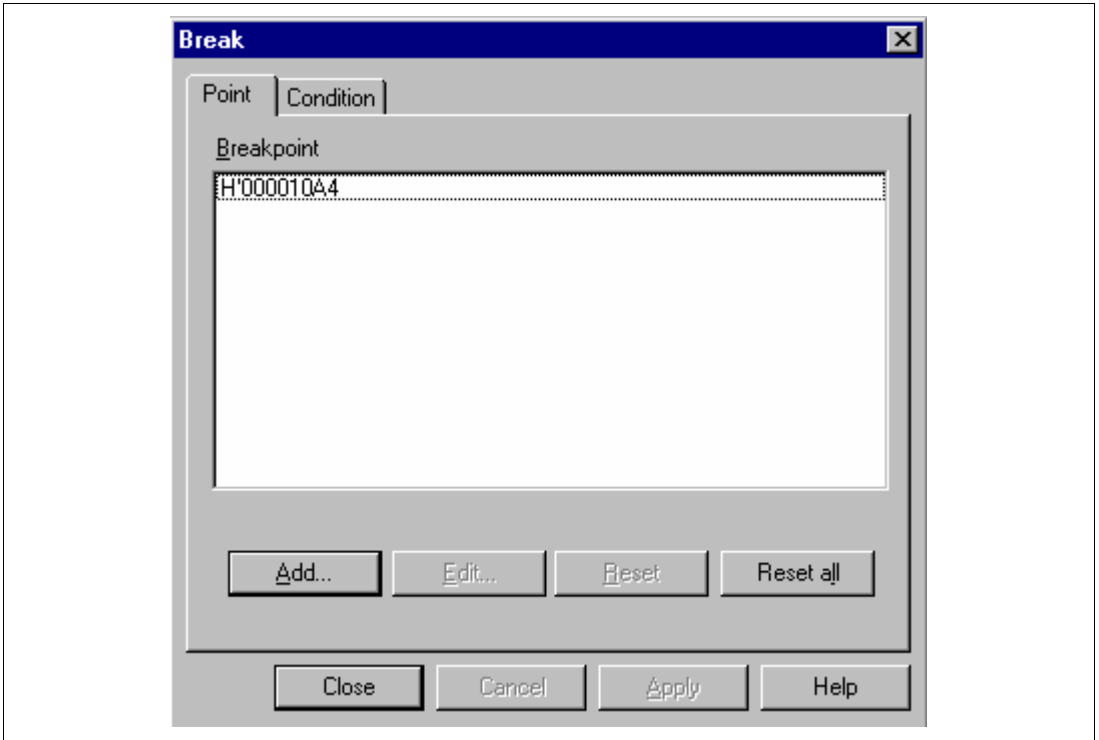
- Enter *H' 10a4* to the [Value] edit box.



**Figure 3.35 [Breakpoint] Dialog Box**

- Click the [OK] button.

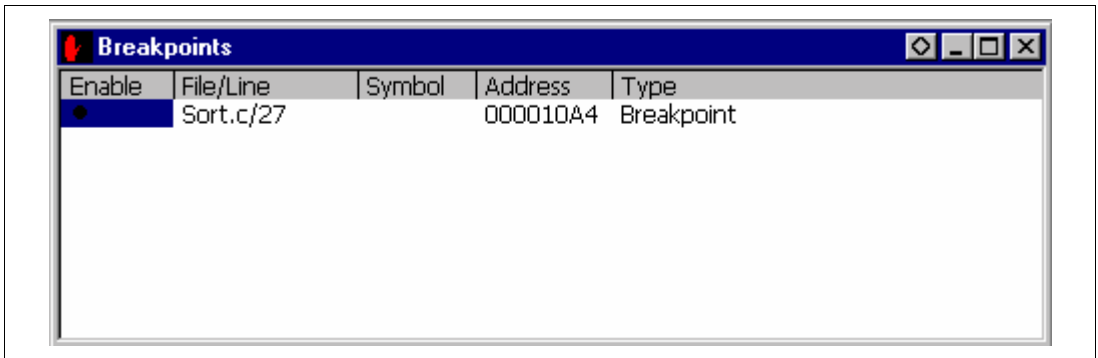
The [Break] dialog box is displayed. The address set in the value field of [Breakpoint] is displayed.



**Figure 3.36 [Point] Page ([Break] Dialog Box) (After Software Breakpoint Setting)**

- Click the [Close] button.

The software breakpoint that has been set is displayed in the [Breakpoints] window.

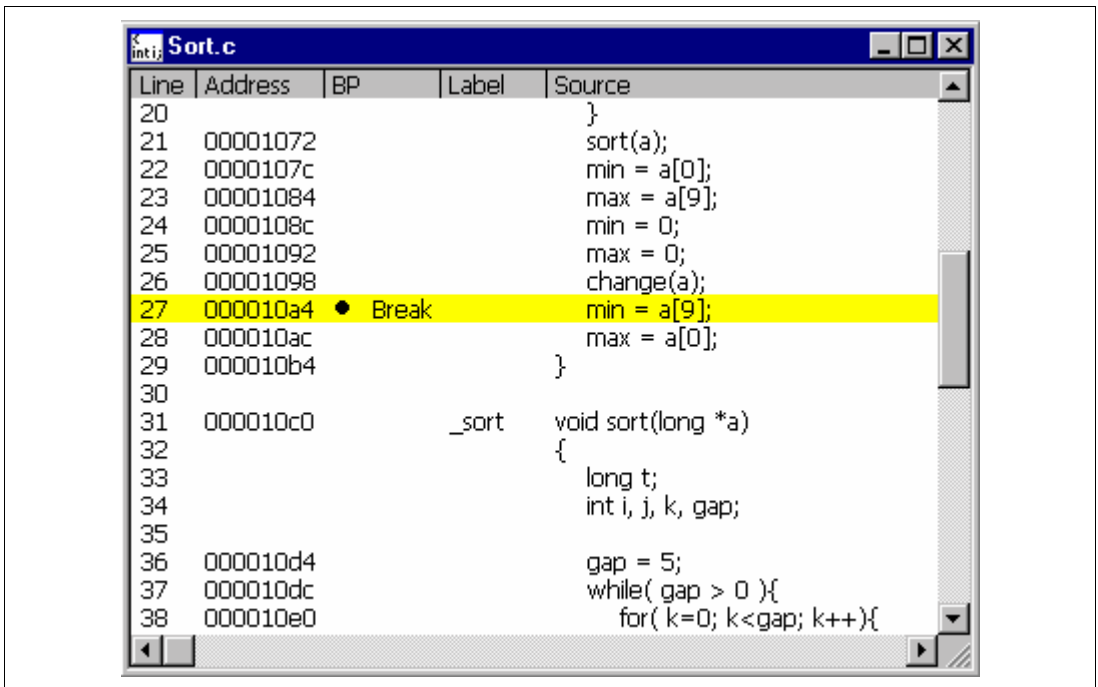


**Figure 3.37 [Breakpoints] Window (Software Breakpoint Setting)**

To stop the tutorial program at the breakpoint, the following procedure must be executed:

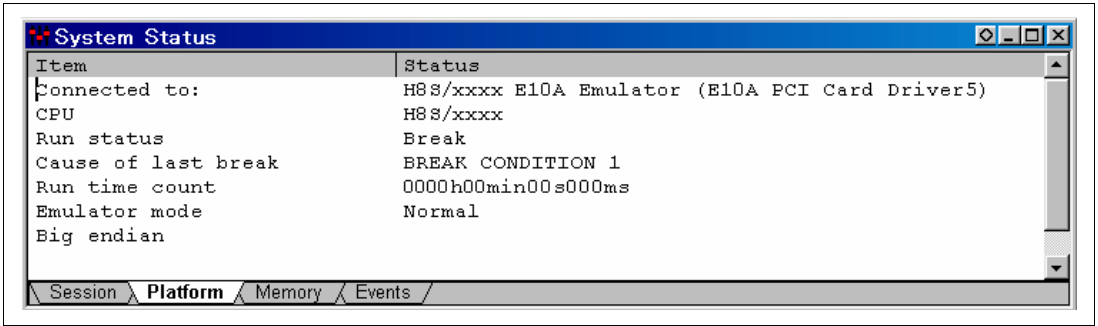
- Close the [Breakpoints] window.
- Click the [Reset Go] button.

The program runs, and stops at the set breakpoint.



**Figure 3.38 [Program] Window at Execution Stop (Software Break)**

The [System Status] window displays the following contents.



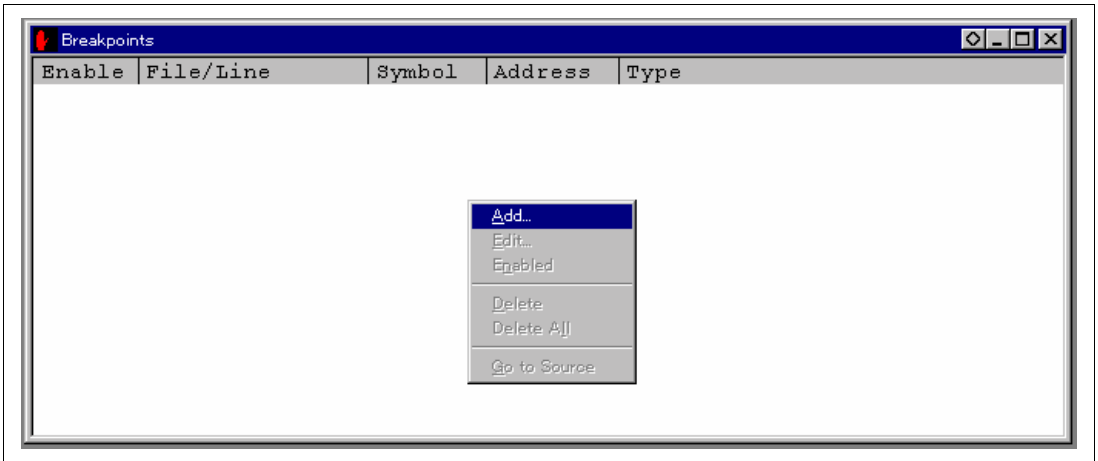
**Figure 3.39** Displayed Contents of the [System Status] Window (Software Break)

**Note:** The items that can be displayed in this window differ according to the product. For the items that can be displayed, refer to the on-line help.

### 3.16 Hardware Break Function

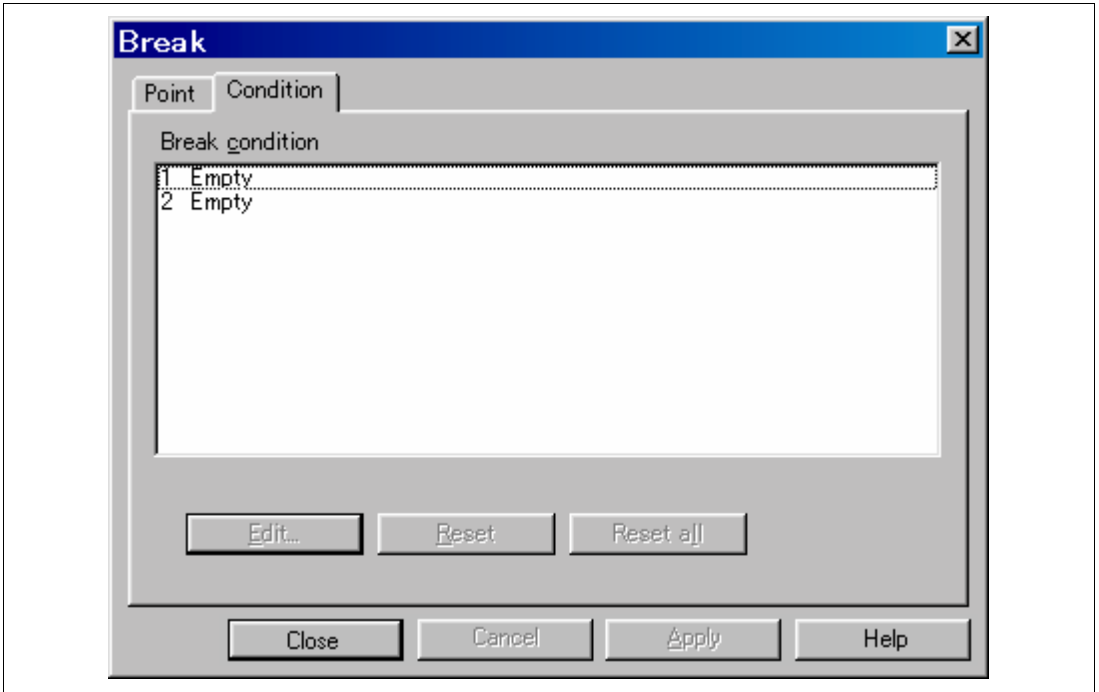
A method is given below in which the address bus condition and the read cycles for the state condition are set under Break condition 1 as hardware break conditions.

- Select [Breakpoint Window] from the [View] menu. The [Breakpoints] window is displayed.
- Click the [Breakpoints] window with the right mouse button and select [Delete All] from the pop-up menu to cancel all breakpoints that have been set.
- Click the [Breakpoints] window with the right mouse button and select [Add] from the pop-up menu.



**Figure 3.40 [Breakpoints] Window (Before Hardware Break Condition Setting)**

The [Break] dialog box is displayed. To set hardware break conditions, select [Condition] in the [Break] dialog box to display the [Condition] page.



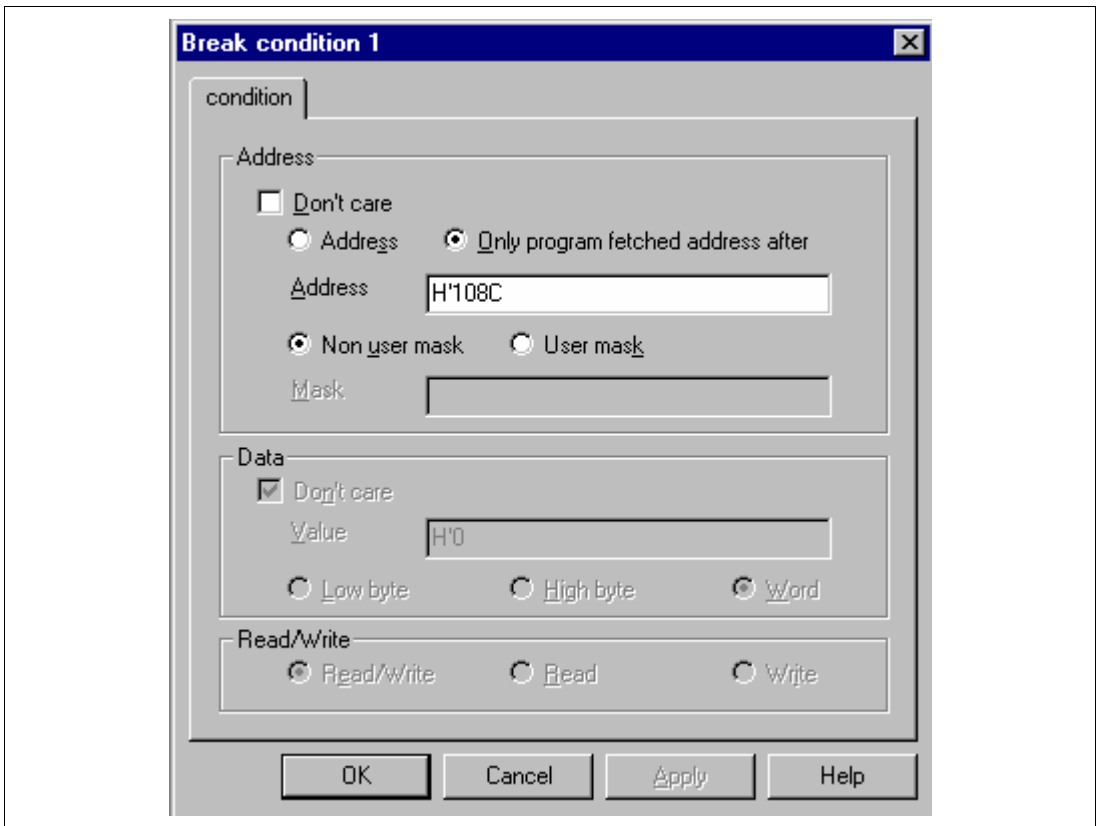
**Figure 3.41 [Condition] Page ([Break] Dialog Box)**

Up to two breakpoints can be set independently for the hardware break condition. In this example, set the hardware break condition for Break condition 1.

**Note:** Note that the number of hardware break conditions differs according to the product. For the number that can be specified for each product, refer to the on-line help.



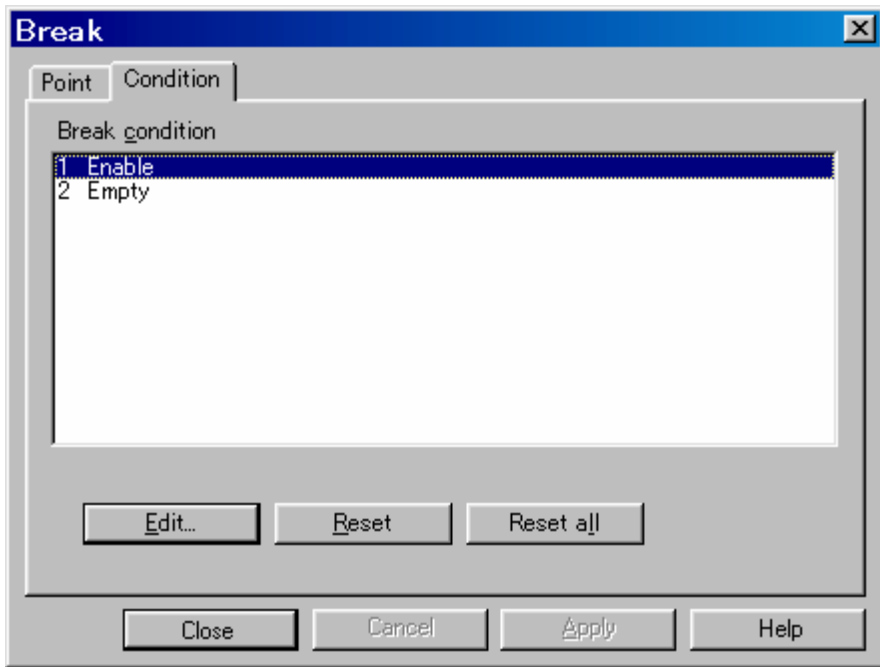
- Highlight the first point in the [Break condition] list box.
- Click the [Edit...] button. The [Break condition 1] dialog box is displayed.
- Clear the [Don't care] check box in the [Address] page.
- Select the [Only program fetched address after] radio button and enter **H'108C** as the value in the [Address] edit box.



**Figure 3.42 [condition] Page ([Break condition 1] Dialog Box)**

**Note:** The items that can be set in this window differ according to the product. For the settings for each product, refer to the on-line help.

- Click the [OK] button.
- The [Break] dialog box is displayed. Check the first point display in the [Break condition] list box is changed from Empty to Enable.



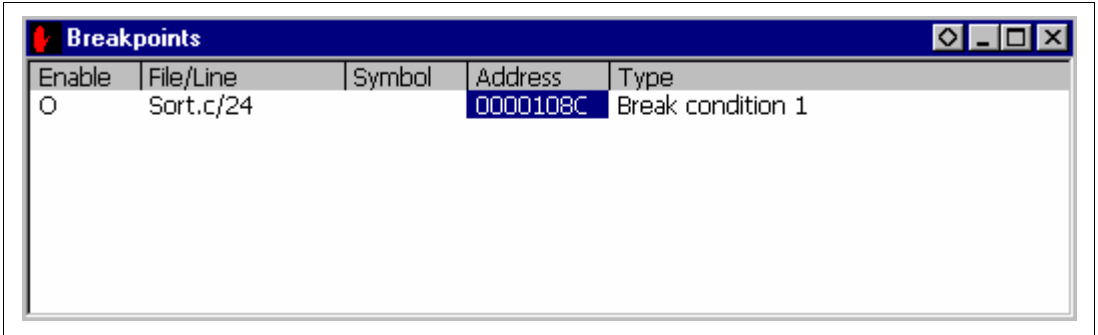
**Figure 3.43 [Break] Dialog Box (After Hardware Break Condition Setting)**

**Note:** Note that the number of hardware break conditions differs according to the product. For the number that can be specified for each product, refer to the on-line help.

- Click the [Close] button.

The newly set hardware breakpoint is displayed in the [Breakpoints] window. With this setting, Break condition 1 is displayed in [Type] in the [Breakpoints] window.

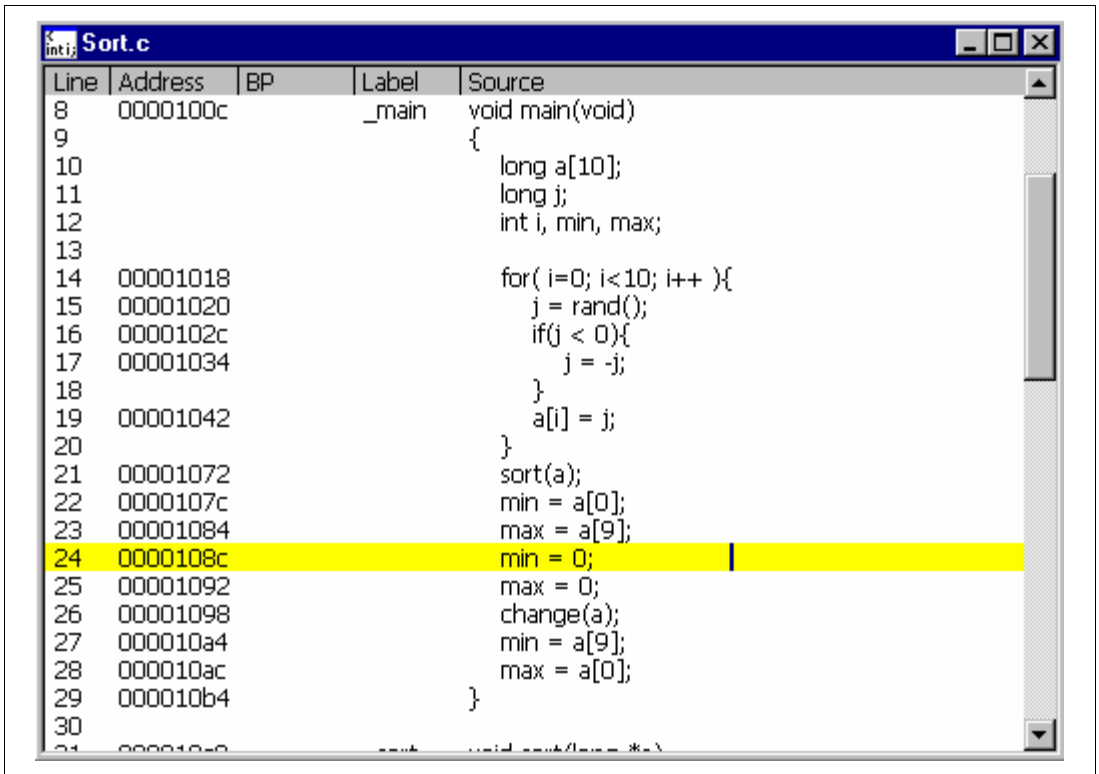
This completes the setting of the Break condition 1 hardware break condition. When the program is executed, a break will occur when address H'108C is accessed in a read cycle.



**Figure 3.44 [Breakpoints] Window ([Break condition 1] Setting)**

- Close the [Breakpoints] window.
- Click the [Reset Go] button.

The program runs then stops at the condition specified under Break condition 1.

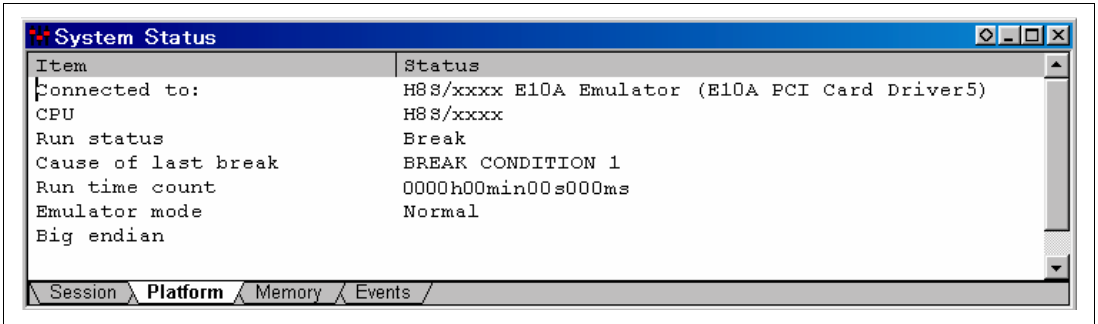


The screenshot shows a debugger window titled "Sort.c" with a table of source code. The table has four columns: Line, Address, BP, Label, and Source. Line 24, which contains the code "min = 0;", is highlighted in yellow. The code is as follows:

Line	Address	BP	Label	Source
8	0000100c		_main	void main(void)
9				{
10				long a[10];
11				long j;
12				int i, min, max;
13				
14	00001018			for( i=0; i<10; i++ ){
15	00001020			j = rand();
16	0000102c			if(j < 0){
17	00001034			j = -j;
18				}
19	00001042			a[i] = j;
20				}
21	00001072			sort(a);
22	0000107c			min = a[0];
23	00001084			max = a[9];
24	0000108c			min = 0;
25	00001092			max = 0;
26	00001098			change(a);
27	000010a4			min = a[9];
28	000010ac			max = a[0];
29	000010b4			}
30				
31	000010c0			return void printf("min = %d\n", min);

**Figure 3.45 [Program] Window at Execution Stop (Break condition 1)**

The [System Status] window displays the following contents.



**Figure 3.46** Displayed Contents of the [System Status] Window (Break condition 1)

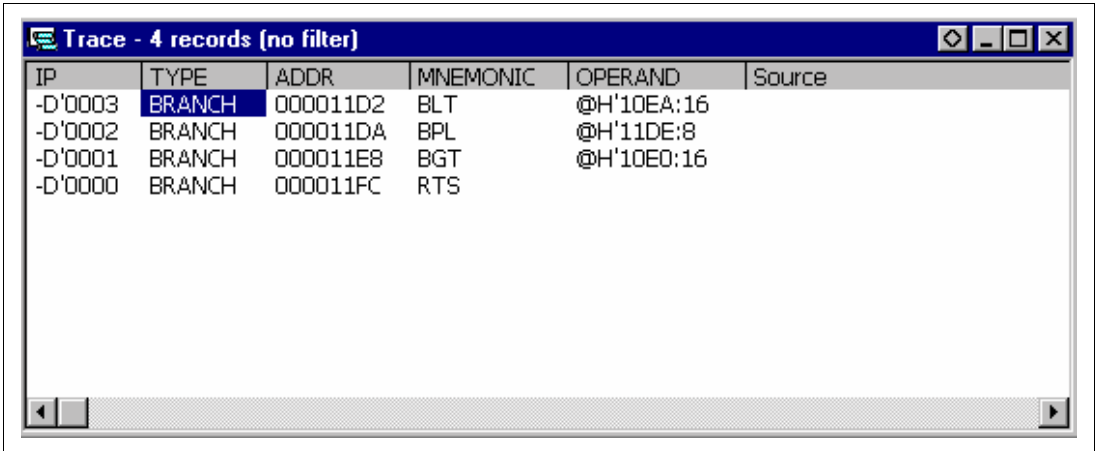
**Note:** The items that can be displayed in this window differ according to the product. For the items that can be displayed, refer to the on-line help.

### 3.17 Trace Function

The trace function of the E10A emulator is described.

The branch source addresses, mnemonics, operands, and source lines are displayed. Since this function uses the trace buffer built into the MCU, a realtime trace can be acquired.

Run the program as shown in the example of section 3.15.1, Software Break Function. The trace results are displayed in the [Trace] window after the program execution is completed.



The screenshot shows a window titled "Trace - 4 records (no filter)". The window contains a table with the following data:

IP	TYPE	ADDR	MNEMONIC	OPERAND	Source
-D'0003	BRANCH	000011D2	BLT	@H'10EA:16	
-D'0002	BRANCH	000011DA	BPL	@H'11DE:8	
-D'0001	BRANCH	000011E8	BGT	@H'10E0:16	
-D'0000	BRANCH	000011FC	RTS		

Figure 3.47 [Trace] Window

- If necessary, adjust the column width by dragging the header bar immediately below the title bar.

**Note:** The number of branch instructions that can be acquired by a trace differs according to the product. For the number that can be specified for each product, refer to the on-line help.

### **3.18 What Next?**

This tutorial has described the major features of the emulator and the use of the HDI.

Sophisticated debugging can be carried out by using the emulation functions that the emulator offers. This provides for effective investigation of hardware and software problems by accurately isolating and identifying the conditions under which such problems arise.

Further details on the use of the HDI can be found in the separately issued Hitachi Debugging Interface User's Manual.





# Section 4 Descriptions of Windows

## 4.1 HDI Windows

HDI window menu bars and the corresponding pull-down menus are listed in table 4.1. Where a description of a menu is included in the Hitachi Debugging Interface User's Manual or in this manual, an O mark or the relevant section number is shown. Related commands in the E10A Emulator User's Manual are also shown.

**Table 4.1 HDI Window Menus and Related Manual Entries**

<b>Menu Bar</b>	<b>Pull-Down Menu</b>	<b>Hitachi Debugging Interface User's Manual</b>	<b>This Manual</b>
File menu	New Session...	O	—
	Load Session...	O	—
	Save Session	O	2.6
	Save Session As...	O	—
	Load Program...	O	3.6.1
	Initialize	O	—
	Exit	O	—
Edit Menu	Cut	O	—
	Copy	O	—
	Paste	O	—
	Find...	O	—
	Evaluate...	O	—

**Table 4.1 HDI Window Menus and Related Manual Entries (cont)**

<b>Menu Bar</b>	<b>Pull-Down Menu</b>	<b>Hitachi Debugging Interface User's Manual</b>	<b>This Manual</b>
View Menu	Breakpoints	O	3.10, 3.15.1, 4.2.3, 6.4.3
	Command Line	O	—
	Disassembly...	O	—
	I/O Registers	O	—
	Labels	O	—
	Locals	O	3.14
	Memory...	O	3.11
	Performance Analysis	O	—
	Profile-List	O	—
	Profile-Tree	O	—
	Registers	O	3.8
	Source...	O	3.6.2
	Status	O	3.9, 3.15.1, 4.2.9
	Trace	O	4.2.8, 6.4.4
	Watch	O	3.12
Localized Dump Window	O	—	
Run Menu	Reset CPU	O	—
	Go	O	3.9
	Reset Go	O	—
	Go to Cursor	O	—
	Set PC To Cursor	O	—
	Run...	O	—
	Step In	O	3.13.1
	Step Over	O	3.13.3
	Step Out	O	3.13.2
	Step...	O	—
	Halt	O	—

**Table 4.1 HDI Window Menus and Related Manual Entries (cont)**

<b>Menu Bar</b>	<b>Pull-Down Menu</b>	<b>Hitachi Debugging Interface User's Manual</b>	<b>This Manual</b>
Memory Menu	Refresh	O	—
	Load	O	—
	Save	O	—
	Verify	O	—
	Test	O	—
	Fill	O	—
	Copy	O	—
	Compare	O	—
Setup Menu	Status bar	O	—
	Options	O	—
	Radix	O	—
	Customise	O	—
	Configure Platform...	O	3.5, 4.2
Window Menu	Cascade	O	—
	Tile	O	—
	Arrange Icons	O	—
	Close All	O	—
Help Menu	Index	O	—
	Using Help	O	—
	Search for Help on	O	—
	About HDI	O	—

## 4.2 Descriptions of Each Window

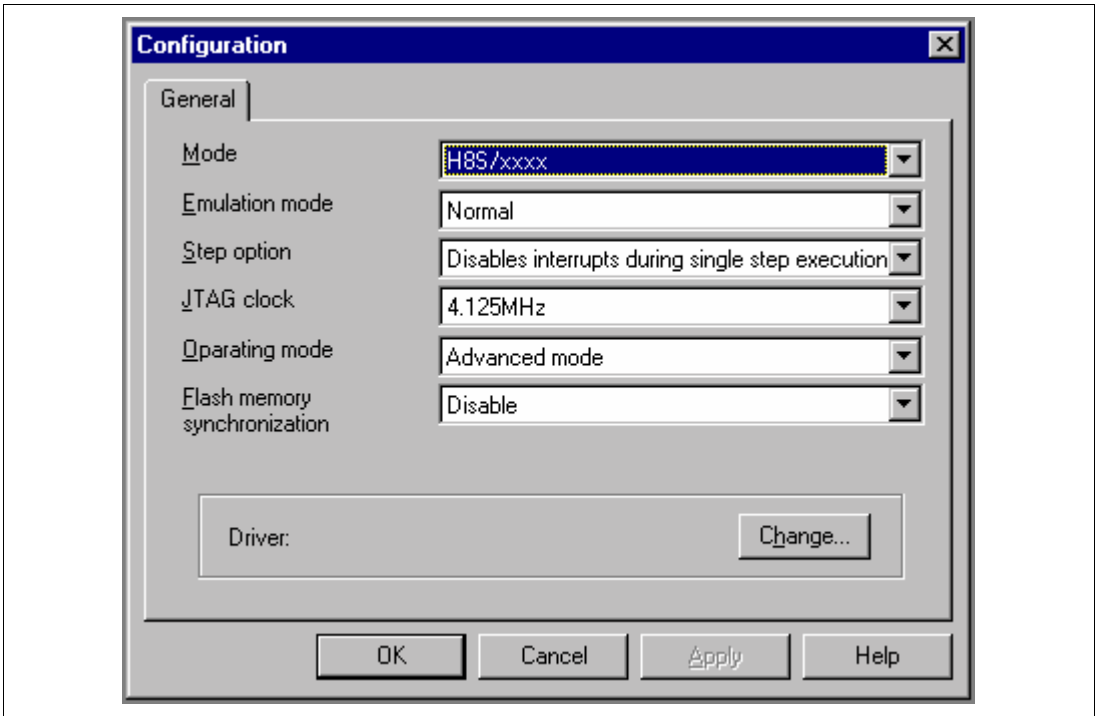
This section describes each window. Figures in this section are used as examples. Each E10A emulator type has explanatory notes. Read section 6, H8S/xxxx E10A Emulator Specifications.

### 4.2.1 [Configuration] Dialog Box

**Function:**

This dialog box sets the emulation conditions of the emulator.

**Window:**



**Figure 4.1 [Configuration] Dialog Box**

**Note:** The items that can be set in this window differ according to the product. For the settings for each product, refer to the on-line help.

**Description:**

The [Configuration] dialog box consists of the [General] page listed in table 4.2.

**Table 4.2 [Configuration] Dialog Box Page**

<b>Page Name</b>	<b>Description</b>
[General]	Sets the emulator operation conditions.

Clicking the [OK] button sets the emulation conditions. If the [Cancel] button is clicked, this dialog box is closed without setting the emulation conditions.

## (1) [General] Page ([Configuration] Dialog Box)

### Function:

This page sets the operational conditions for the emulator. The MCU name is displayed, the emulation mode and interrupts during step execution are set, the JTAG clock (TCK) is displayed and set, and the driver is selected.

### Window:

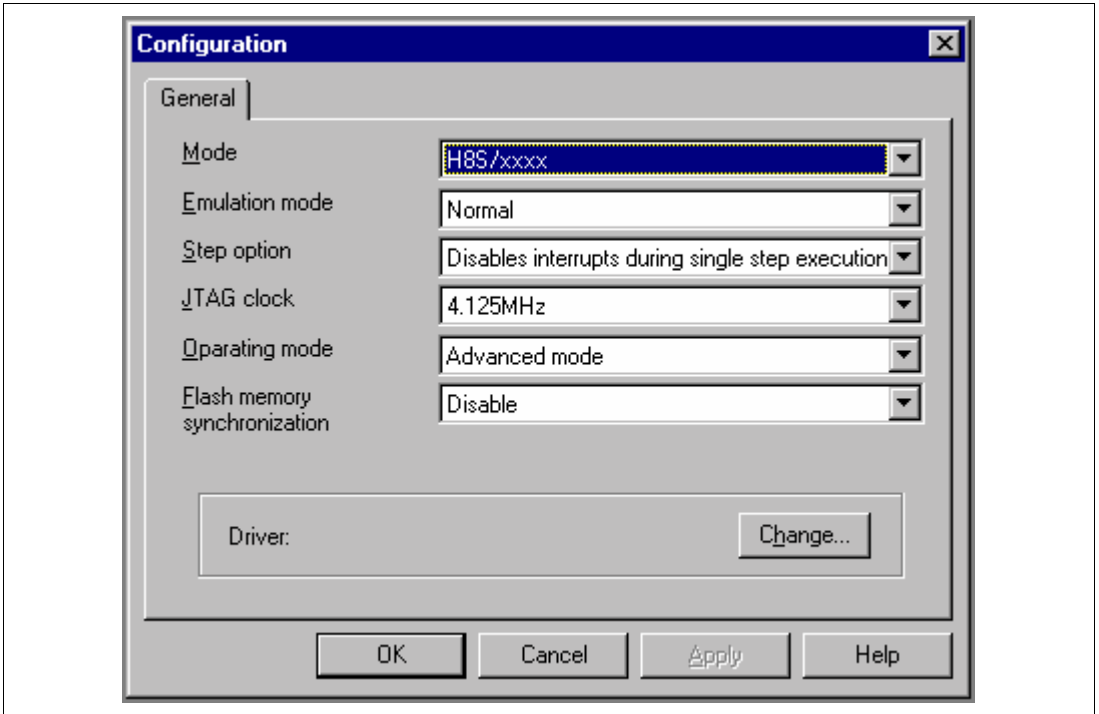


Figure 4.2 [General] Page ([Configuration] Dialog Box)

**Note:** The items that can be set in this window differ according to the product. For the settings for each product, refer to the on-line help.

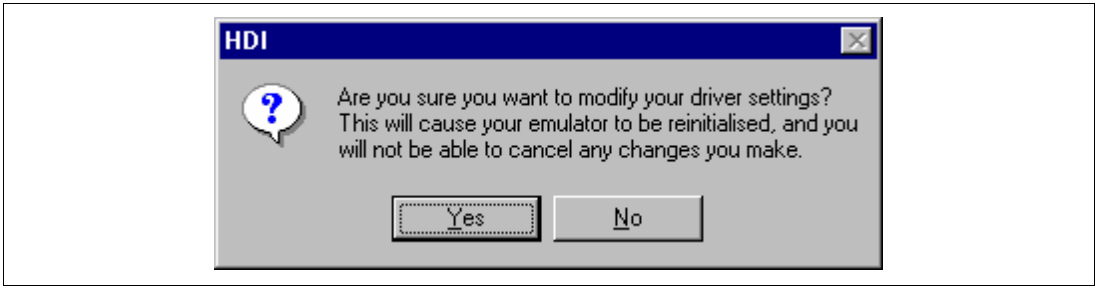
## Description:

**Table 4.3 [General] Page Options**

<b>Option</b>	<b>Description</b>
[Mode] combo box	Displays the MCU name.
[Emulation mode] combo box	Selects the emulation mode at user program execution. Select Normal to perform normal emulation. Select No Break to disable breakpoint settings.
[Step option] combo box	Enables or disables interrupts during step execution. Disables interrupts during single step execution: Interrupts during step execution are masked. Enables interrupts during single step execution: Interrupts during step execution are released.
[JTAG clock] combo box	Sets the JTAG frequency*.
[Operating mode] combo box	Displays the operating mode determined by the MD pin.
[Flash memory synchronization] combo box	Synchronization method is set between the host computer and the flash memory.  When synchronization is performed from the host computer to the flash memory, a waiting time will be generated to write the flash memory during user program halting, but the displayed contents and the flash memory are always matched.  When synchronization is performed from the flash memory to the host computer, the rewritten contents in the user program mode will be reflected since the flash memory is read during user program halting.  Disable: Synchronization is not performed except when the E10A emulator is activated and the flash memory area is modified.  PC to Flash memory: Synchronization is performed from the host computer to the flash memory.  Flash memory to PC: Synchronization is performed from the flash memory to the host computer.  PC to Flash memory, Flash memory to PC: Synchronization is performed between the host computer and the flash memory.
[Driver] group box	The [E10A Driver Details] dialog box is displayed. Changes the driver currently connected.

**Note:** The range of frequencies that the JTAG operates at is different according to the devices used. For details, refer to section 6.5.4, Notes on Using the JTAG Clock (TCK).

When a driver is to be changed with the [Change...] button, the following message is displayed.



**Figure 4.3 Warning Message Box**

When the [Yes] button is clicked, the [E10A Driver Details] dialog box is displayed. When the [No] button is clicked, the display returns to the [Configuration] dialog box.

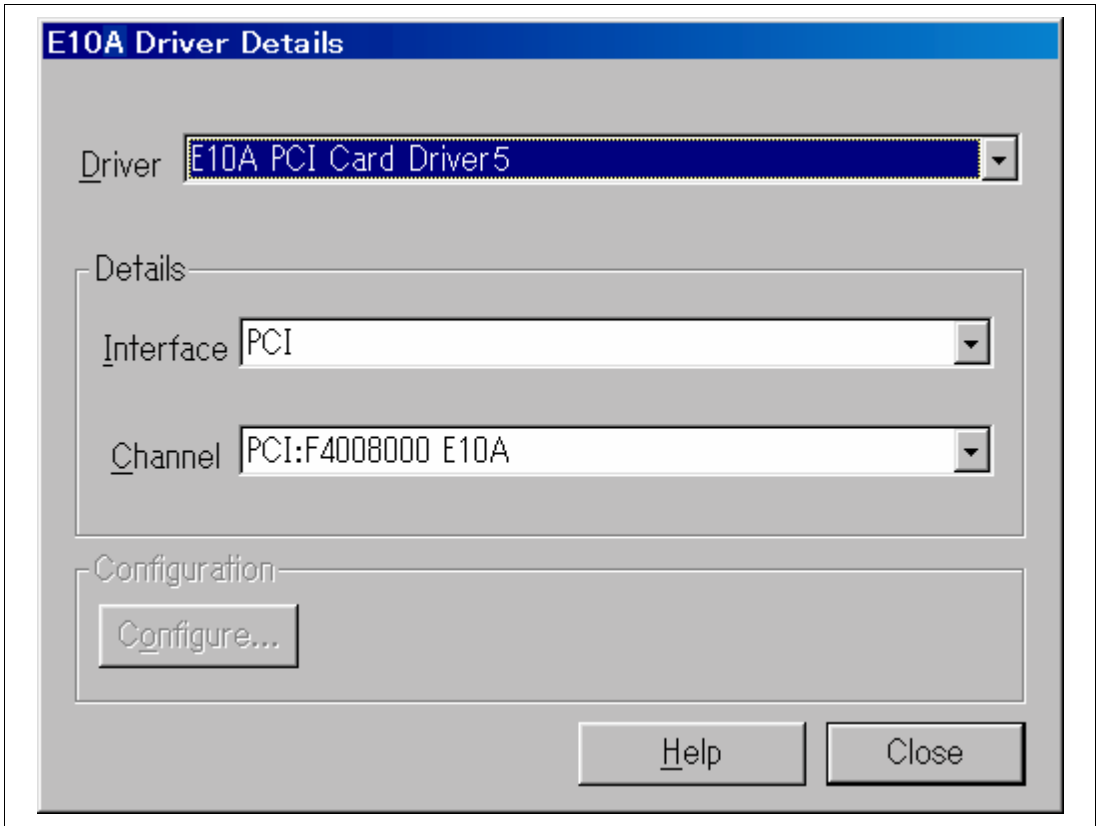
**Related Items:**

- [Configuration] dialog box
- GO\_OPTION command
- STEP\_INTERRUPT command



## 4.2.2 [E10A Driver Details] Dialog Box

When the [OK] button is clicked, the [E10A Driver Details] dialog box will appear to select the driver software used by the interface to the emulator. Since the emulator is reinitialized after this dialog box is closed, it cannot be cancelled.



**Figure 4.4 [E10A Driver Details] Dialog Box**

Table 4.4 shows each option.

**Table 4.4 [E10A Driver Details] Dialog Box Option**

Option	Description
[Driver] combo box	Selects the driver to connect the HDI with the emulator.
[Interface] combo box	Selects the interface name of the card emulator to be connected.
[Channel] combo box	Selects the interface that the PC interface board has been connected.
[Configure...] button	Clicked to display that the driver supports the configuration dialog box.

When the PCMCIA card emulator is used, [E10A PC Card Driver 5] is selected. When the PCI card emulator is used, [E10A PCI Card Driver 5] is selected.

Note: When the HDI is not linked up even if the above procedure has been executed, the driver may not be set correctly. Install drivers provided with the \SETUP directory in the CD-R according to the screen instructions.

**Related Items:**

[Configuration] dialog box

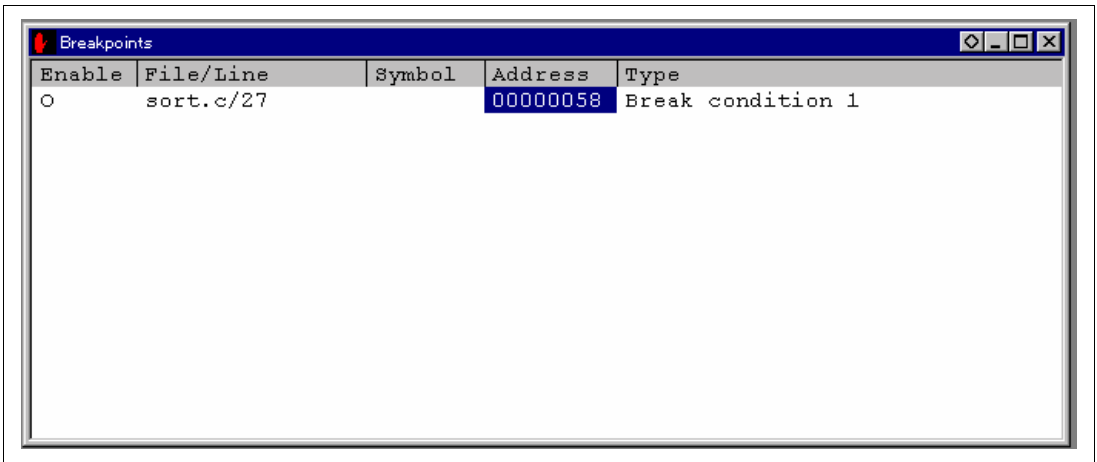
[General] page

### 4.2.3 [Breakpoints] Window

**Function:**

This window lists all break conditions that have been set.

**Window:**



**Figure 4.5 [Breakpoints] Window**

## Description:

The [Breakpoints] window displays breakpoint setting information. The items listed in the following tables are displayed.

**Table 4.5 [Breakpoints] Window Display Items**

Item	Description
[Enable]	Indicates whether the break condition is enabled or disabled. Symbol ● or ○ shows that the break condition is enabled.
[File/Line]	Displays the file name and line number where the breakpoint is set.
[Symbol]	Displays the symbol corresponding to the breakpoint address. If no symbol has been defined for the address, a blank is displayed.
[Address]	Displays the address where the breakpoint is set.
[Type]	Displays the break condition type as follows: Breakpoint: Software breakpoint Break condition n: Hardware break condition (n is a number)

The pop-up menu, which is opened by clicking the right mouse button, can be used to set, change, and clear breakpoints, and to enable or disable break conditions. The pop-up menu functions are described in the following table.

**Table 4.6 [Breakpoints] Window Pop-up Menu Operation**

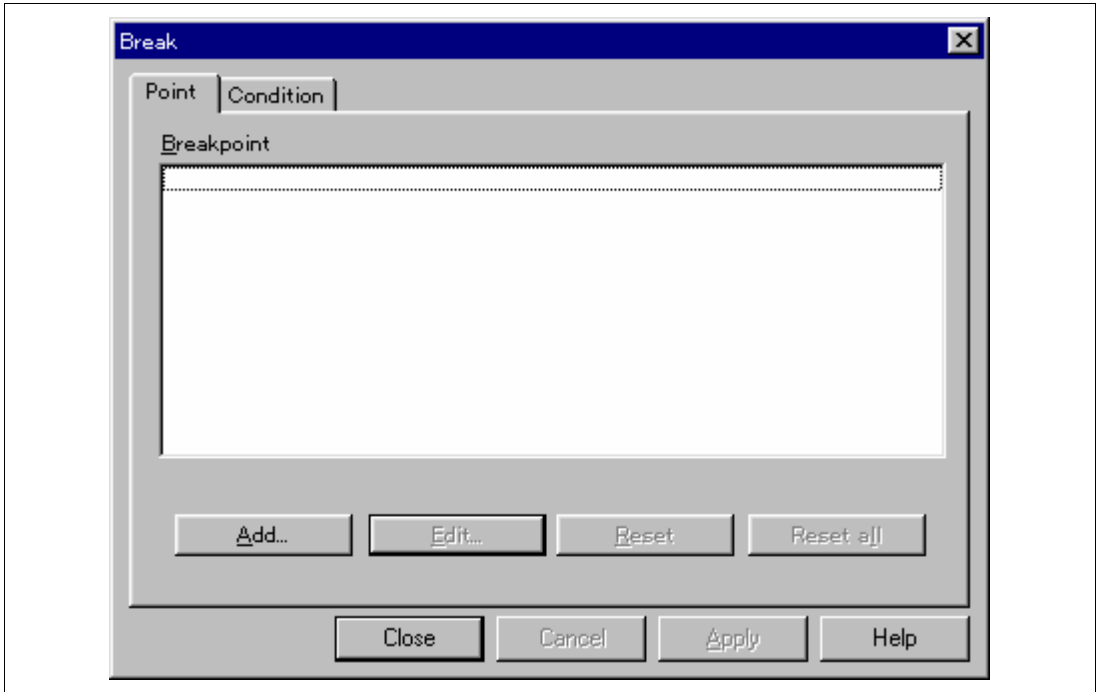
Menu Name	Description
[Add]	Sets break conditions. Clicking this button will display the [Break] dialog box, enabling break conditions to be set.
[Edit]	Changes break conditions. Select break conditions to be changed and click this button. The break condition setting dialog box will be displayed, enabling the break condition to be changed.
[Disable] ([Enable])	Enables or disables break conditions. Select break conditions to be enabled or disabled and click this button.
[Delete]	Clears break conditions. Select break conditions to be cleared and click this button.
[Delete All]	Clears all break conditions.
[Go to Source]	Jumps to the address which sets the break in the [Source] window.

#### 4.2.4 [Break] Dialog Box

**Function:**

This dialog box displays the break condition settings.

**Window:**



**Figure 4.6 [Break] Dialog Box**

**Description:**

The [Break] dialog box consists of the pages listed in table 4.7.

**Table 4.7 [Break] Dialog Box Pages**

<b>Page Name</b>	<b>Description</b>
[Point]	Displays software breakpoint settings.
[Condition]	Displays Break Condition settings.

The dialog boxes which set or modify break conditions can be displayed from the pages above.

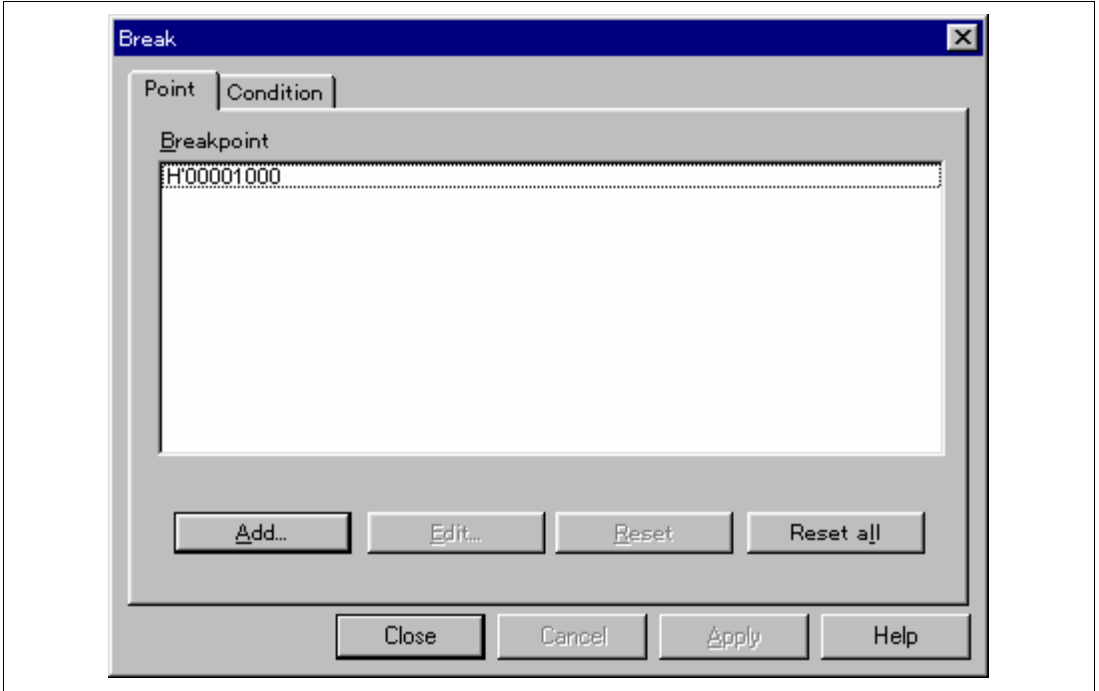
Clicking the [Close] button will close this dialog box. The [Apply] button is not supported.

## (1) [Point] Page ([Break] Dialog Box)

### Function:

This page displays software breakpoint settings. In this page, software breakpoints can be set, changed, and cleared.

### Window:



**Figure 4.7 [Point] Page ([Break] Dialog Box)**

## Description:

**Table 4.8 [Point] Page Options**

<b>Option</b>	<b>Description</b>
[Breakpoint] list box	Lists the software breakpoints currently being set. The display contents are as follows: <breakpoint address>
[Add...] button	Sets software breakpoints. Clicking this button displays the [Breakpoint] dialog box.
[Edit...] button	Changes the software breakpoint selected in the [Breakpoint] list box. Clicking this button displays the [Breakpoint] dialog box.
[Reset] button	Clears the software breakpoint selected in the [Breakpoint] list box.
[Reset all] button	Clears all software breakpoints displayed in the [Breakpoint] list box.

## Related Items:

[Breakpoint] dialog box

BREAKPOINT command

BREAKPOINT\_CLEAR command

BREAKPOINT\_DISPLAY command

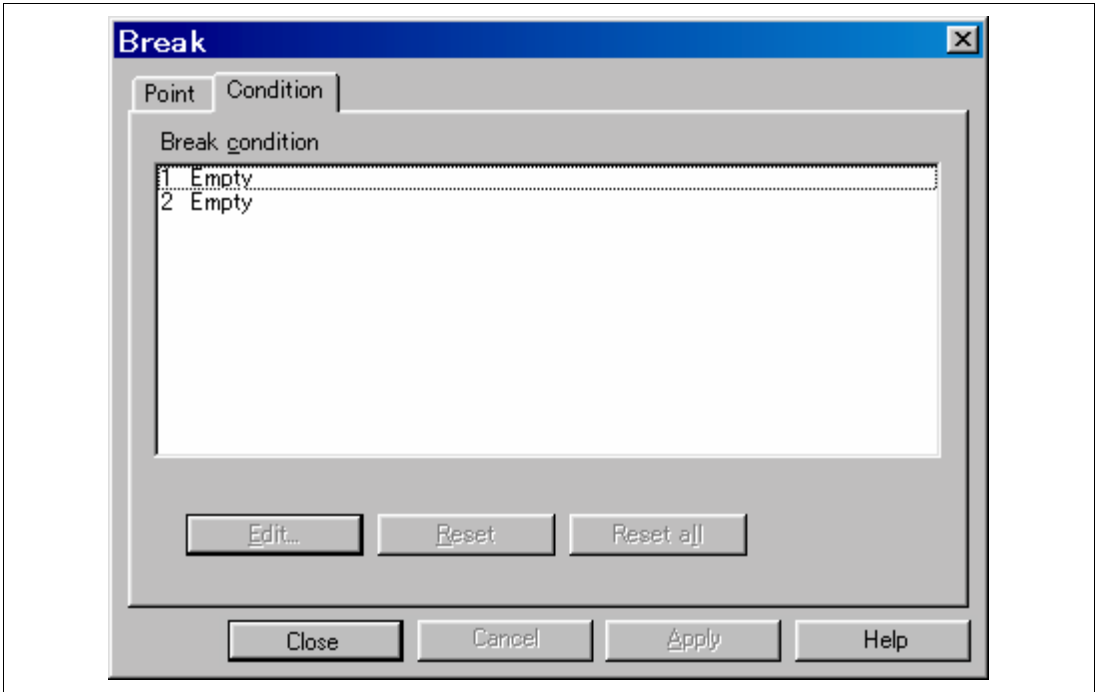
BREAKPOINT\_ENABLE command

## (2) [Condition] Page ([Break] Dialog Box)

### Function:

This page displays the Break Condition settings. These conditions can also be set or cleared in this page.

### Window:



**Figure 4.8 [Condition] Page ([Break] Dialog Box)**

**Note:** Note that the number of hardware break conditions differs according to the product. For the number that can be specified for each product, refer to the on-line help.



## Description:

**Table 4.9 [Condition] Page Options**

<b>Option</b>	<b>Description</b>
[Break condition] list box	Displays the Break condition settings. The display at system initiation is as follows: When conditions are set, Enable is displayed. When no conditions are set, Empty is displayed. <ol style="list-style-type: none"><li>1 Empty (setting of Break condition 1)</li><li>2 Empty (setting of Break condition 2)</li></ol> <p style="text-align: center;">:</p>
[Edit...] button	Changes the Break condition settings selected in the [Break condition] list box. Clicking this button displays the [Break condition] dialog boxes.
[Reset] button	Clears the Break condition settings selected in the [Break condition] list box.
[Reset all] button	Clears all Break condition settings in the [Break condition] list box.

## Related Items:

[condition] page

BREAKCONDITION\_CLEAR command

BREAKCONDITION\_DISPLAY command

BREAKCONDITION\_ENABLE command

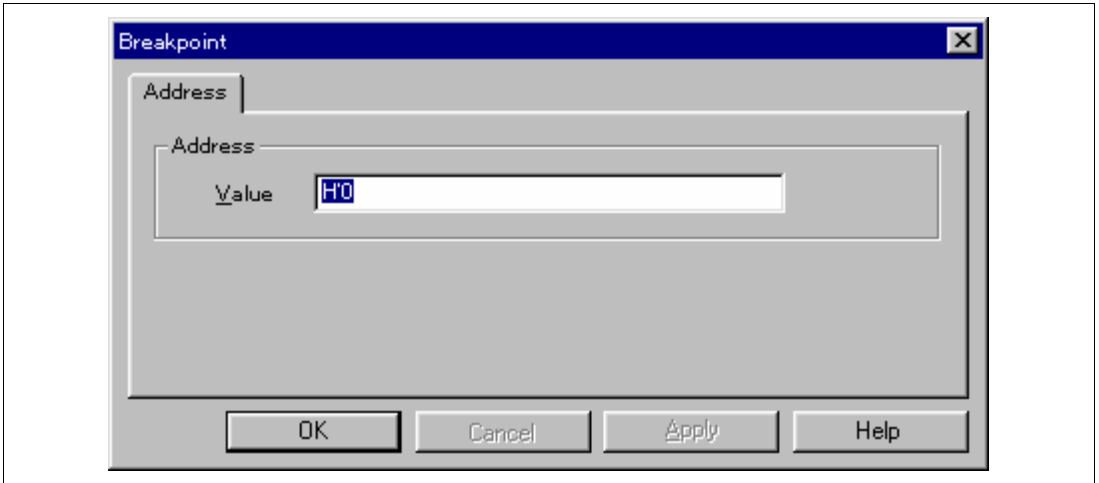
BREAKCONDITION\_SET command

## 4.2.5 [Breakpoint] Dialog Box

### Function:

This dialog box sets software breakpoints.

### Window:



**Figure 4.9 [Breakpoint] Dialog Box**

**Note:** The items that can be set in this window differ according to the product. For the settings for each product, refer to the on-line help.

**Description:**

The [Address] page options are as follows:

**Table 4.10** [Address] Page Options

<b>Option</b>	<b>Description</b>
[Value] edit box	Sets a breakpoint address with a number or a symbol.

Clicking the [OK] button enables breakpoints to be set. If the [Cancel] button is clicked, this dialog box is closed without setting breakpoints.

**Related Items:**

[Point] page

BREAKPOINT command

BREAKPOINT\_CLEAR command

BREAKPOINT\_DISPLAY command

BREAKPOINT\_ENABLE command

## 4.2.6 [Break condition] Dialog Box

### Function:

This dialog box sets hardware break conditions.

### Window:

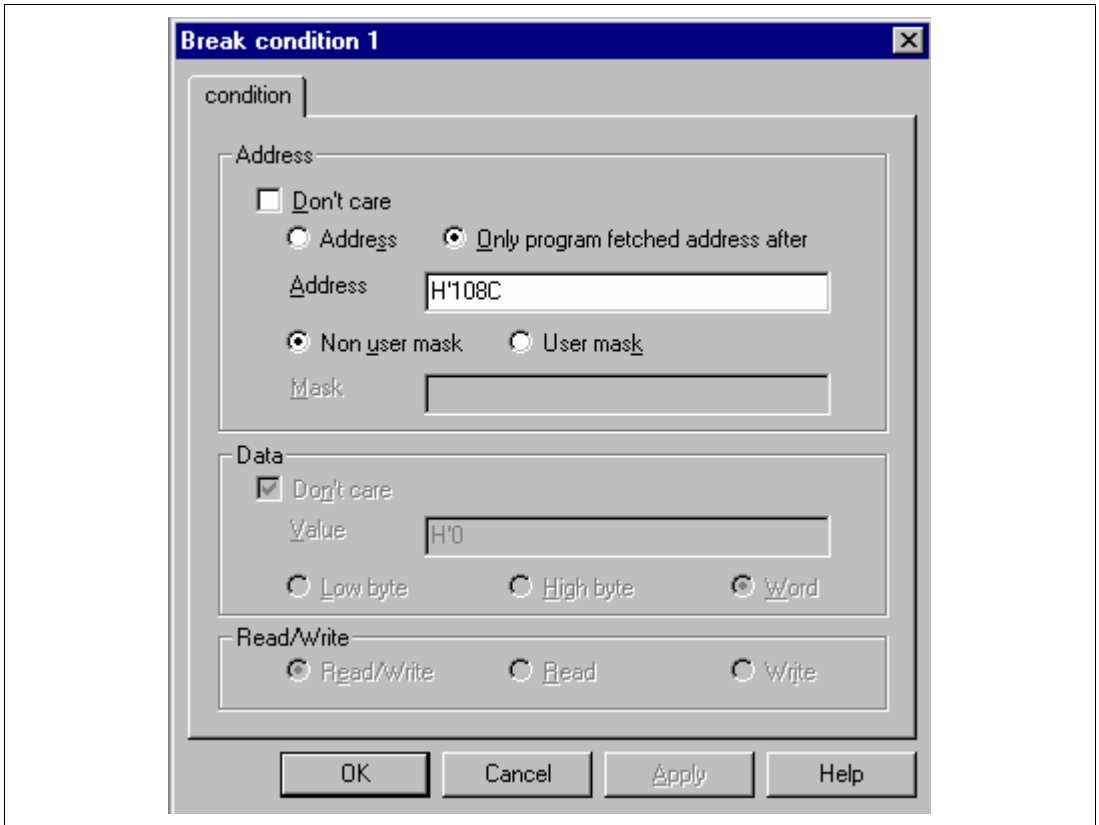


Figure 4.10 [Break condition 1] Dialog Box

**Note:** The items that can be set in this window differ according to the product. For the settings for each product, refer to the on-line help.

**Description:**

The [Break condition] dialog box consists of the [condition] page. Sets the conditions for halting the program.

Contents to be set by this page are described in section 4.2.7, [Break condition] Dialog Box Pages.

Clicking the [OK] button sets the hardware break conditions. If the [Cancel] button is clicked, the dialog box is closed without setting the hardware break conditions.

**Related Items:**

[condition] page

BREAKPOINT command

BREAKCONDITION\_CLEAR command

BREAKCONDITION\_DISPLAY command

BREAKCONDITION\_ENABLE command

## 4.2.7 [Break condition] Dialog Box Pages

The [Break condition] dialog box page allows a number of hardware break conditions to be set. Some functions may not be supported by some types of emulators. The setting conditions may differ from those in table 4.11. For details, refer to section 6.5.2, Hardware Break Functions.

**Table 4.11 Setting Conditions in [Break condition] Dialog Box**

Dialog Box	Type		
	Address Bus Condition	Data Bus Condition	Read/Write Condition
[Break condition 1] dialog box	<input type="radio"/>	<input type="radio"/>	<input type="radio"/>
[Break condition 2] dialog box	<input type="radio"/>	<input type="radio"/>	<input type="radio"/>

Note: : Can be set by checking the radio button in the dialog box.

Table 4.12 shows the [Break condition] dialog box page.

**Table 4.12 [Break condition] Dialog Box Pages**

Page Name	Function
[condition]	Sets the address bus, data bus, and read/write cycle conditions of Break condition.

**Note:** This function differs according to the product. For the specifications of each product, refer to section 6.5.2, Hardware Break Functions, or to the on-line help.

## (1) [condition] Page

### Function:

This page sets the address bus, data bus, and read/write cycle conditions.

### Window:

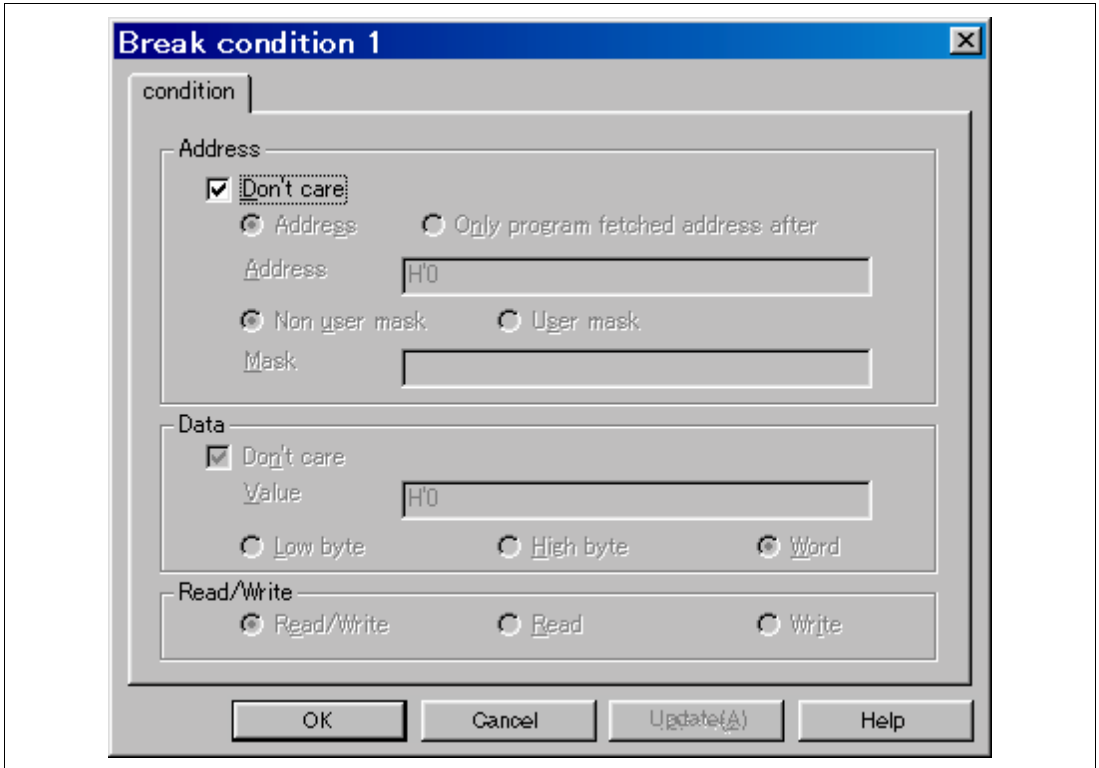


Figure 4.11 [condition] Page

**Note:** The items that can be set in this window differ according to the product. For the settings for each product, refer to the on-line help.

**Description:**

The [Address] group box sets the address bus conditions.

**Table 4.13 [Address] Group Box Options**

<b>Option</b>	<b>Description</b>
[Don't care] check box	Does not set address conditions.
[Address] radio button	Sets use of the normal address bus as break conditions.
[Only program fetched address after] radio button	Sets a break after prefetched address execution as break conditions.
[Address] edit box	Sets the address bus value with a number or a symbol.
[Mask] list box	Sets the mask bits if [User mask] is selected. For masked bits, the break condition is satisfied regardless of the address values.

The contents of an option that can be set will change depending on the radio button selected.

**Table 4.14 Radio Button Options**

<b>Option</b>	<b>Description</b>
[Address] radio button	All conditions can be set.
[Only program fetched address after] radio button	The [Address] condition can be set.

The [Data] group box sets the data bus conditions.

**Table 4.15 [Data] Group Box Options**

<b>Option</b>	<b>Description</b>
[Don't care] check box	No data conditions are set.
[Value] edit box	Sets the data bus with a number.
[Low byte] radio button	Sets data access size as the lower 8-bit access.
[High byte] radio button	Sets data access size as the upper 8-bit access.
[Word] radio button	Sets data access size as the word access.



The [Read/Write] group box sets the read/write cycle conditions.

**Table 4.16 [Read/Write] Group Box Options**

<b>Option</b>	<b>Description</b>
[Read/Write] radio button	Sets the read/write cycle conditions as break conditions.
[Read] radio button	Sets read cycles as break conditions.
[Write] radio button	Sets write cycles as break conditions.

**Related Items:**

[Condition] page

BREAKCONDITION\_CLEAR command

BREAKCONDITION\_DISPLAY command

BREAKCONDITION\_ENABLE command

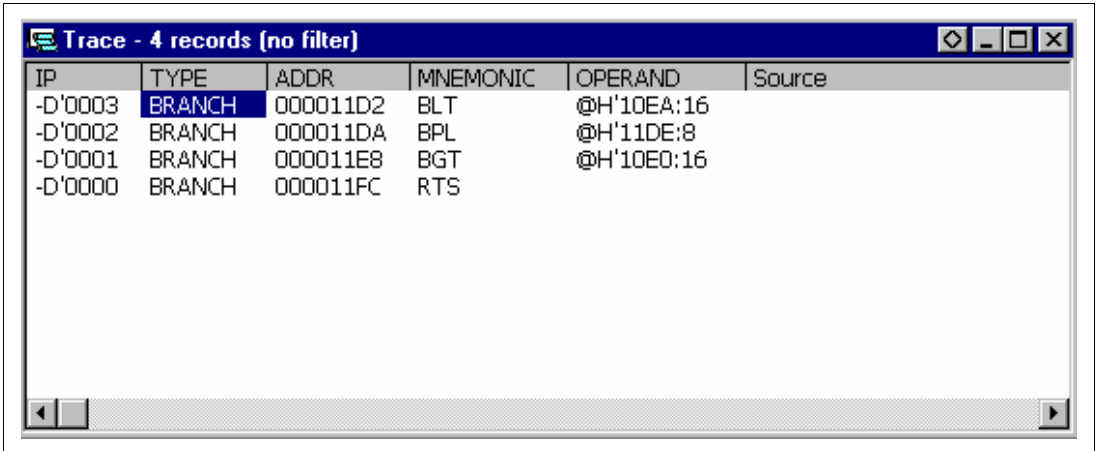
BREAKCONDITION\_SET command

## 4.2.8 [Trace] Window

### Function:

This window displays the trace buffer contents. The contents are displayed in both C and assembly languages to simplify debugging.

### Window:



The screenshot shows a window titled "Trace - 4 records (no filter)". The window contains a table with the following data:

IP	TYPE	ADDR	MNEMONIC	OPERAND	Source
-D'0003	BRANCH	000011D2	BLT	@H'10EA:16	
-D'0002	BRANCH	000011DA	BPL	@H'11DE:8	
-D'0001	BRANCH	000011E8	BGT	@H'10E0:16	
-D'0000	BRANCH	000011FC	RTS		

Figure 4.12 [Trace] Window

**Note:** This function differs according to the product. For the number that can be specified for each product, refer to the on-line help.

**Description:**

This window displays the trace buffer contents. The items listed in table 4.17 are displayed.

**Table 4.17 [Trace] Window Display Items**

<b>Item</b>	<b>Description</b>
[IP]	Displays the instruction pointer (signed decimal).
[TYPE]	Displays the branch source. BRANCH: Branch source
[ADDR]	Displays the branch source address.
[MNEMONIC]	Displays the execution instruction mnemonic.
[OPERAND]	Displays the execution instruction operand.
[Source]	Displays the C-source line of the address that the trace has been acquired.
[Total Records]	Displays the total number of instructions displayed as trace information in the [Trace] window.

The pop-up menu, opened by clicking the right mouse button, can be used to set, change, and clear trace conditions. For details, refer to the Hitachi Debugging Interface User's Manual.

Note: The [Halt] menu in the pop-up menu is active only when the [Trace] window is open during user program execution. Realtime emulation cannot be performed by using the [Halt] menu.

**Related Item:**

TRACE\_DISPLAY command

## 4.2.9 [System Status] Window

### Function:

This window lists information, such as conditions that have been set to the emulator and execution results.

### Window:

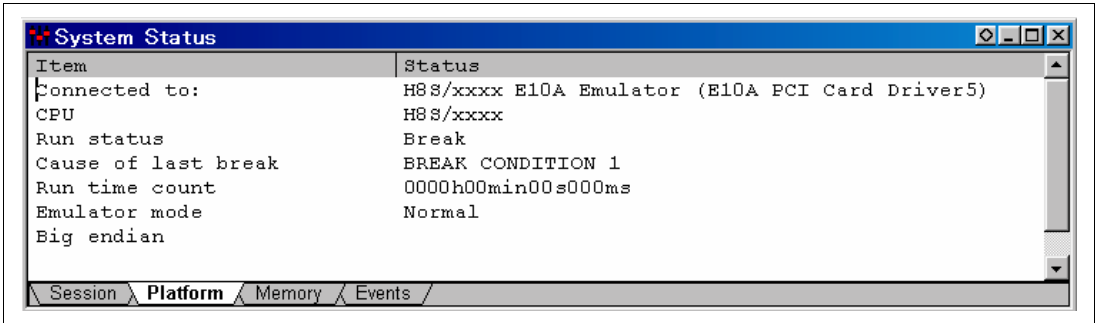


Figure 4.13 [System Status] Window

**Note:** The items that can be displayed in this window differ according to the product. For the items that can be displayed, refer to the on-line help.

## Description:

The items listed in the following table are displayed in the [System Status] window.

**Table 4.18 [System Status] Window Display Items**

Page	Item	Description
[Session]	Target System	Displays whether the emulator is connected.
	Session Name	Displays the session file name.
	Program Name	Displays the load module file name.
[Platform]	Connected To	Displays the name of the connected emulator and the selected driver name.
	CPU	Displays the target MCU name.
	Run status	Displays the execution status: Running: Being executed Break: Stopped
	Cause of last break	Displays the cause of the emulator stopping at break.
	Run time count	Displays the program execution time. The display format is h: hours, min: minutes, s: seconds, and ms: milliseconds. In this example, 0000h00min00s000ms is displayed.
	Emulator mode	Displays the emulator operating mode (setting information for [Emulation Mode] of the [Configuration] dialog box).
[Memory]	Loaded Memory Areas	Displays the loaded area of the load module.
[Events]	Resources	Displays the usage states of software breakpoint and Break condition.

## Related Items:

[Configuration] dialog box  
STATUS command



# Section 5 Command-line Functions

## 5.1 Table and Symbol Description

This section describes the format used in section 5.2, Command Descriptions. The descriptions of some commands are given over two or more pages.

### 5.1.1 Format

The input format for each command is as follows. Characters shown in bold-italics are to be input.

[ ] : Parameters enclosed by [ ] can be omitted.

< > : Contents shown in < > are set.

< >=: The parameter to the left of the "=" sign is input in the format shown to the right.

| : This represents a non-exclusive selection.

|| : This represents an exclusive selection.

The command parameter details are described in the parameter table.

### 5.1.2 Parameter Input

#### Numerical Parameters:

A binary, octal, decimal, or hexadecimal value, a symbol, or a formula can be input. A symbol can contain up to 32 characters. Terms in a formula are separated with operators (such as + or -).

#### Keyword Parameters:

One of the bold characters given in the description column of the table can be input. If a character string not shown in the description is input, an error will occur.

#### Character-String Parameters:

Character-string parameters are used to input mask data or a file name. In the mask data, set a radix (H': hexadecimal or B': binary) at the top of a character string and set \* at the digit to be masked.

### **5.1.3 Examples**

These are actual input examples. For commands whose execution results in a specific display output, an example of the display is given.

### **5.1.4 Related Items**

Related E10A HDI commands (abbreviations) and dialog boxes are shown. (Refer to section 4, Descriptions of Windows.)



## 5.2 Command Descriptions

The command list of the E10A emulator is shown below.

**Table 5.1 E10A HDI Commands**

No	Command	Abb.	Function
1	BREAKCONDITION_CLEAR	BCC	Clears hardware breakpoints that have been set.
2	BREAKCONDITION_DISPLAY	BCD	Displays hardware breakpoints that have been set.
3	BREAKCONDITION_ENABLE	BCE	Enables or disables hardware breakpoints that have been set.
4	BREAKCONDITION_SET	BCS	Sets hardware breakpoints.
5	BREAKPOINT	BP	Sets software breakpoints.
6	BREAKPOINT_CLEAR	BC	Clears software breakpoints that have been set.
7	BREAKPOINT_DISPLAY	BD	Displays software breakpoints that have been set.
8	BREAKPOINT_ENABLE	BE	Enables or disables software breakpoints that have been set.
9	DEVICE_TYPE	DE	Displays MCU type currently selected.
10	GO_OPTION	GP	Sets or displays the emulation mode during user program execution.
11	JTAG_CLOCK	JCK	Displays or sets a JTAG clock (TCK) frequency.
12	REFRESH	RF	Updates the HDI memory information to the latest contents.
13	RESET	RE	Resets the H8S/xxxx.
14	STATUS	STS	Displays emulator status information.
15	STEP_INTERRUPT	SI	Sets or displays the enable or disable status of interrupts during step execution.
16	TRACE_DISPLAY	TD	Displays acquired trace information.

**Note:** Support for these commands varies with the product. For the specifications of each product, refer to the on-line help.

## 5.2.1 BREAKCONDITION\_CLEAR: BCC

### Description:

Clears hardware breakpoints that have been set.

### Format:

```
bcc [<channel>]
```

<channel> = channel <channel\_number>

**Table 5.2 BREAKCONDITION\_CLEAR Command Parameter**

Parameter	Type	Description
None		

### Examples:

To clear all hardware breakpoints:

```
>bcc (RET)
```

To clear all hardware breakpoints set at channel 2:

```
>bcc channel 2 (RET)
```

## 5.2.2 BREAKCONDITION\_DISPLAY: BCD

### Description:

Displays hardware breakpoints that have been set. The display contents include enable or disable of the setting, and setting conditions.

### Format:

```
bcd [<channel>]
```

<channel> = channel <channel\_number>

**Table 5.3 BREAKCONDITION\_DISPLAY Command Parameter**

Parameter	Type	Description
None		

### Examples:

To display all hardware breakpoint settings:

```
>bcd (RET)
```

```
Break Condition 1:Enable data 20 long
```

```
Break Condition 2:Disable address 126
```

To display the hardware breakpoint set at channel 1:

```
>bcd channel 1 (RET)
```

```
Break Condition 1:Enable data 20 long
```

**Note:** The items displayed with this command vary with the product. For the display specifications of each product, refer to the on-line help.

### 5.2.3 BREAKCONDITION\_ENABLE: BCE

#### Description:

Enables or disables hardware breakpoints that have been set.

#### Format:

```
bce [<channel>] <mode>
```

<channel> = channel <channel\_number>

**Table 5.4 BREAKCONDITION\_ENABLE Command Parameter**

Parameter	Type	Description
<mode>	Keyword	Enables or disables hardware breakpoint settings. Set either of the following: <b>enable</b> : Enables hardware break settings. <b>disable</b> : Disables hardware break settings.

#### Examples:

To enable all hardware breakpoints:

```
>bce enable (RET)
```

To disable the hardware breakpoints set at channel 1:

```
>bce channel 1 disable (RET)
```

## 5.2.4 BREAKCONDITION\_SET: BCS

### Description:

Sets hardware breakpoints.

Note: The function will be different according to the MCUs used. For functions of each emulator product, refer to section 6.4.2, Hardware Break Functions.

### Format:

```
bcs <channel> <option> [<option> ... ]
```

<channel>	=	channel <channel_number>
<option>	=	[<addropt>   <dataopt>   <asidopt>   <r/wopt>]
<addropt>	=	address <address> [<addrcycle>]    address mask <maskdata> <addrcycle>
<dataopt>	=	data <data> <size>
<r/wopt>	=	direction <direction>

**Table 5.5 BREAKCONDITION\_SET Command Parameters**

<b>Parameter</b>	<b>Type</b>	<b>Description</b>
<address>	Numerical value, character string	Numerical value or symbol representing an address bus value
<addrcycle>	Keyword	Address bus access conditions <b>pcafter</b> : The address bus is targeted during instruction fetch cycles. Breaks after the instruction at the address set by the <address> parameter is executed. When <addrcycle> is omitted, the address in the program fetch cycles, and the address bus during data access cycles are targeted.
<maskdata>	Keyword	Address bus mask conditions Conditions are satisfied regardless of the values of masked bits. Set a radix H' or B' and set * in the bit to be masked.
<data>	Numerical value	Data bus value
<size>	Keyword	Sets the access conditions of the data bus. When <size> is omitted, a byte size is specified. Specify either of the following: <b>lbyte</b> : lower 8 bits <b>hbyte</b> : upper 8 bits <b>word</b> : word size
<direction>	Keyword	Read/write conditions Set either of the following keywords: <b>read</b> : read cycles <b>write</b> : write cycles

**Note:** The parameters for this command vary with the product. For the specifications of each product, refer to the on-line help.

## Examples:

To set the following conditions as a hardware breakpoint:

Address condition: An address bus value of H'1000,

Data condition: A data bus value of H'55 and lower 8-bit byte access,

Read/write cycle condition: Read cycle.

```
>bcs address 1000 data 55 lbyte direction read (RET)
```

To set the following conditions as a hardware breakpoint:

Address condition: An address bus value of H'2000 and instruction fetch cycle.

```
>bcs address 2000 pafter (RET)
```

To set the following conditions as a hardware breakpoint:

Address condition: The lower 4 bits of H'1000 are masked,

Data condition: A data bus value of H'aa and upper 8-bit byte access.

```
>bcs address mask 100* data aa hbyte (RET)
```

## 5.2.5 BREAKPOINT: BP

### Description:

Sets software breakpoints.

Note: The function will be different according to the MCUs used.

### Format:

```
bp <address>
```

**Table 5.6 BREAKPOINT Command Parameter**

Parameter	Type	Description
<address>	Numerical value, character string	Breakpoint value set by numerical value or symbol When an odd address is set, the address is rounded down to an even address.

**Note:** The parameters for this command vary with the product. For the specifications of each product, refer to the on-line help.

### Examples:

To set a software breakpoint at address H'12c8:

```
>bp H'12c8 (RET)
```



## 5.2.6 BREAKPOINT\_CLEAR: BC

### Description:

Clears software breakpoints that have been set.

### Format:

```
bc [<address>]
```

**Table 5.7 BREAKPOINT\_CLEAR Command Parameter**

Parameter	Type	Description
<address>	Numerical value, character string	Breakpoint value set by numerical value or symbol

Note: When no parameters are set, all software breakpoints are cleared.

**Note: The parameters for this command vary with the product. For the specifications of each product, refer to the on-line help.**

### Examples:

To clear all software breakpoints:

```
>bc (RET)
```

To clear all software breakpoints whose address value is H'1000:

```
>bc H'1000 (RET)
```

## 5.2.7 BREAKPOINT\_DISPLAY: BD

### Description:

Displays software breakpoints that have been set.

### Format:

bd

**Table 5.8 BREAKPOINT\_DISPLAY Command Parameter**

Parameter	Type	Description
None		

### Example:

To display the software breakpoints that have been set:

```
>bd (RET)
```

The display format is as follows:

```
>bd
H'00000110 Enable
H'0000011c Disable
H'00000250 Enable
```

**Note:** The items displayed with this command vary with the product. For the display specifications of each product, refer to the on-line help.

## 5.2.8 BREAKPOINT\_ENABLE: BE

### Description:

Enables or disables software breakpoints that have been set.

### Format:

```
be <address> <mode>
```

**Table 5.9 BREAKPOINT\_ENABLE Command Parameters**

Parameter	Type	Description
<address>	Numerical value, character string	Breakpoint value set by numerical value or symbol
<mode>	Keyword	Enables or disables breakpoints. Set either of the following: <b>enable</b> : Enables breakpoints. <b>disable</b> : Disables breakpoints.

### Examples:

To enable software breakpoints that have been set:

```
>be H'1002 enable (RET)
```

To disable software breakpoints that have been set:

```
>be H'1002 disable (RET)
```

- Notes:**
- 1. The parameters for this command vary with the product. For the specifications of each product, refer to the on-line help.**
  - 2. The items displayed with this command vary with the product. For the display specifications of each product, refer to the on-line help.**

## 5.2.9 DEVICE\_TYPE: DE

### Description:

Displays MCU type currently selected.

### Format:

de

**Table 5.10 DEVICE\_TYPE Command Parameter**

Parameter	Type	Description
None		

### Example:

To display the currently selected MCU:

```
>de (RET)
```

The display format is as follows:

```
>de  
Current device = H8S/xxxx
```

## 5.2.10 GO\_OPTION: GP

### Description:

Sets or displays the emulation mode during user program execution.

### Format:

```
gp
```

Displays emulation mode for user program execution.

```
gp <eml_opt>  
<eml_opt> = eml_mode <eml_mode>
```

Sets emulation mode for user program execution.

**Table 5.11 GO\_OPTION Command Parameter**

Parameter	Type	Description
<eml_mode>	Keyword	Specifies the emulation mode. Set either of the following: <b>normal</b> : Normal execution <b>no_break</b> : Makes software breakpoints and hardware breakpoints temporarily invalid and executes the user program.

Note: The parameters for this command vary with the product. For the specifications of each product, refer to the on-line help.

### Examples:

To display the currently set emulation mode for user program execution:

```
>gp (RET)
```

The display format is as follows:

```
>gp  
Emulator execution mode = Normal
```

To set the normal emulation mode for user program execution:

```
>gp eml_mode normal (RET)
```

**Note:** The items displayed with this command vary with the product. For the display specifications of each product, refer to the on-line help.

## 5.2.11 JTAG\_CLOCK: JCK

### Description:

Displays or sets the JTAG clock (TCK) frequency.

### Format:

JCK

Displays the JTAG clock (TCK).

JCK <jck\_opt>

Sets the JTAG clock (TCK).

**Table 5.12 JTAG\_CLOCK Command Parameter**

Parameter	Type	Description
<jck_opt>	Numerical value	Sets one of the JTAG clock (TCK) frequency. (PCMCIA used: 0.937 MHz, 1.875 MHz, 3.75 MHz, 7.5 MHz, or 15 MHz) <b>1:</b> 15 MHz <b>2:</b> 7.5 MHz <b>3:</b> 3.75 MHz <b>4:</b> 1.875 MHz <b>5:</b> 0.937 MHz  (PCI used: 1.031 MHz, 2.062 MHz, 4.125 MHz, 8.25 MHz, or 16.5 MHz) <b>1:</b> 16.5 MHz <b>2:</b> 8.25 MHz <b>3:</b> 4.125 MHz <b>4:</b> 2.062 MHz <b>5:</b> 1.031 MHz

Note: The range of the frequency that the Hitachi-UDI operates at differs according to the MCU to be supported.

## Examples:

### (when PCMCIA used):

To set the JTAG clock (TCK) frequency:

```
>JCK 1 (RET)
```

```
JTAG Clock 15MHz
```

To display the JTAG clock (TCK) frequency:

```
>JCK (RET)
```

```
JTAG Clock 15MHz
```

### (when PCI used):

To set the JTAG clock (TCK) frequency:

```
>JCK 1 (RET)
```

```
JTAG Clock 16.5MHz
```

To display the JTAG clock (TCK) frequency:

```
>JCK (RET)
```

```
JTAG Clock 16.5MHz
```

## 5.2.12 REFRESH: RF

### Description:

Updates the HDI memory information to the latest contents.

### Format:

*rf*

**Table 5.13 REFRESH Command Parameter**

Parameter	Type	Description
None		

### Example:

To update the HDI memory information:

```
>rf (RET)
```



### 5.2.13 RESET: RE

#### Description:

Resets the H8S/xxxx. The breakpoint settings are retained. After the reset, the registers will be in the same state as when power is supplied.

#### Format:

re

**Table 5.14 RESET Command Parameter**

Parameter	Type	Description
None		

#### Example:

To reset the H8S/xxxx:

```
>re (RET)
```

## 5.2.14 STATUS: STS

### Description:

Displays emulator status information.

### Format:

sts

**Table 5.15 STATUS Command Parameter**

Parameter	Type	Description
None		

### Example:

To display status information of the emulator:

```
>sts (RET)
```

The display format is as follows:

```
>sts
Emulator Status
Connected to:      H8S/xxxx E10A Emulator (E10A PC Card Driver 5)
CPU               H8S/xxxx
Run status        Break
Cause of last break BREAK KEY
Run time count    0000h00min00s000ms
Emulator mode     Normal
Big endian
```

**Note:** The items displayed with this command vary with the product. For the display specifications of each product, refer to the on-line help.

## 5.2.15 STEP\_INTERRUPT: SI

### Description:

Sets or displays the enable or disable status of interrupts during step execution. When interrupts occur when they are disabled, execution stops at the top address of the interrupt routine.

### Format:

si

Displays the enable or disable status of interrupts during step execution.

si <mode>

Sets the enable or disable status of interrupts during step execution.

**Table 5.16 STEP\_INTERRUPT Command Parameter**

Parameter	Type	Description
<mode>	Keyword	Enables or disables interrupts during step execution. Set either of the following: <b>enable</b> : Enables interrupts. <b>disable</b> : Disables interrupts.

### Example:

To enable interrupts during step execution:

```
>si enable (RET)
```

To display interrupt status during step execution:

```
>si (RET)  
Emulator step interrupt mode = ENABLE
```

## 5.2.16 TRACE\_DISPLAY: TD

### Description:

Displays acquired trace information.

### Format:

td

**Table 5.17 TRACE\_DISPLAY Command Parameter**

Parameter	Type	Description
None		

### Example:

To display acquired trace information:

```
>td (RET)
```

The display format is as follows:

```
>td
  IP          TYPE          ADDR          MNEMONIC      OPERAND
-D'xxxxx    BRANCH        00001010     JSR           @ER0
-D'xxxxx    BRANCH        00001200     JMP           @ER1
(a)         (b)         (c)         (d)         (e)
```

(a) Instruction pointer (signed decimal)

(b) Type of branch source

BRANCH: Branch source

(c) Address of instruction word

(d) Instruction mnemonic

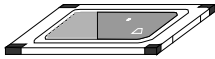
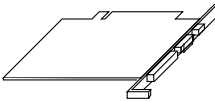
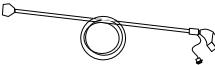
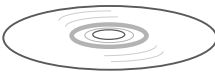
(e) Instruction operand

# Section 6 H8S/2168F E10A Emulator Specifications

## 6.1 Components of the Emulator

The H8S/2168F E10A emulator supports the H8S/2168F. Table 6.1 lists the components of the emulator.

**Table 6.1 Components of the Emulator (HS2168KCM01H or HS2168KCI01H)**

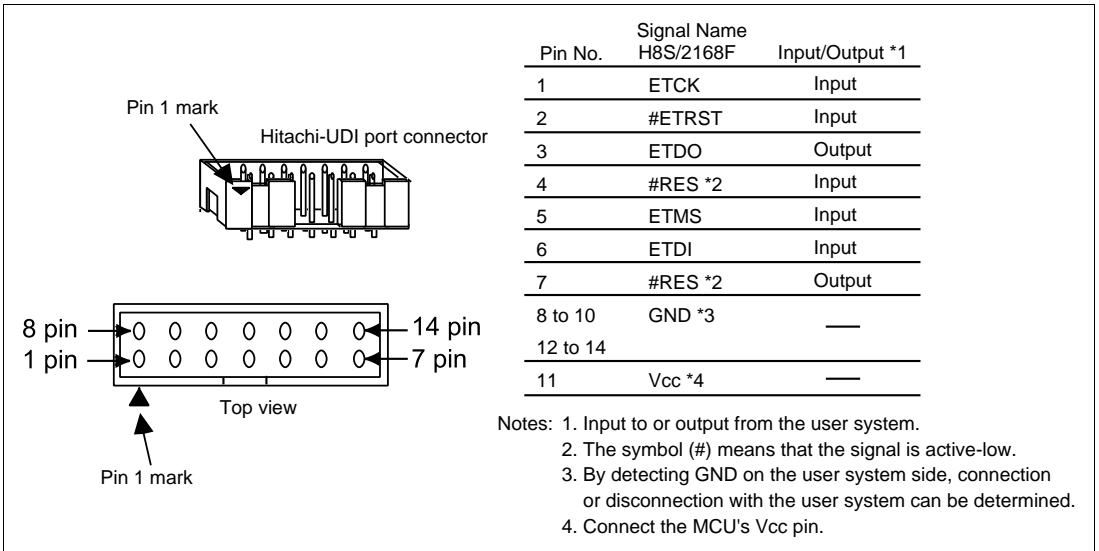
Classification	Component	Appearance	Quantity	Remarks
Hard-ware	Card emulator HS2168KCM01H (Model: HS0005KCM05H), HS2168KCI01H (Model: HS0005KCI05H)		1	HS2168KCM01H (PCMCIA: 14-pin type): Depth: 85.6 mm, Width: 54.0 mm, Height: 5.0 mm, Mass: 30.0 g  HS2168KCI01H (PCI: 14-pin type): Depth: 122.0 mm, Width: 96.0 mm, Mass: 80.0 g
		or 		
	User system interface cable		1	HS2168KCM01H (PCMCIA: 14-pin type): Length: 80.0 cm, Mass: 46.0 g  HS2168KCI01H (PCI: 14-pin type): Length: 150.0 cm, Mass: 90.0 g
Soft-ware	H8S/2168F E10A emulator setup program, H8S/2168F E10A Emulator User's Manual, and Hitachi Debugging Interface User's Manual		1	HS2168KCM01SR, HS2168KCM01HJ, HS2168KCM01HE, HS6400DIIW5SJ, and HS6400DIIW5SE (provided on a CD-R)

## 6.2 Pin Arrangement of the Hitachi-UDI Port Connector

Figure 6.1 shows the pin arrangement of the Hitachi-UDI port connector (14-pin type).

### CAUTION

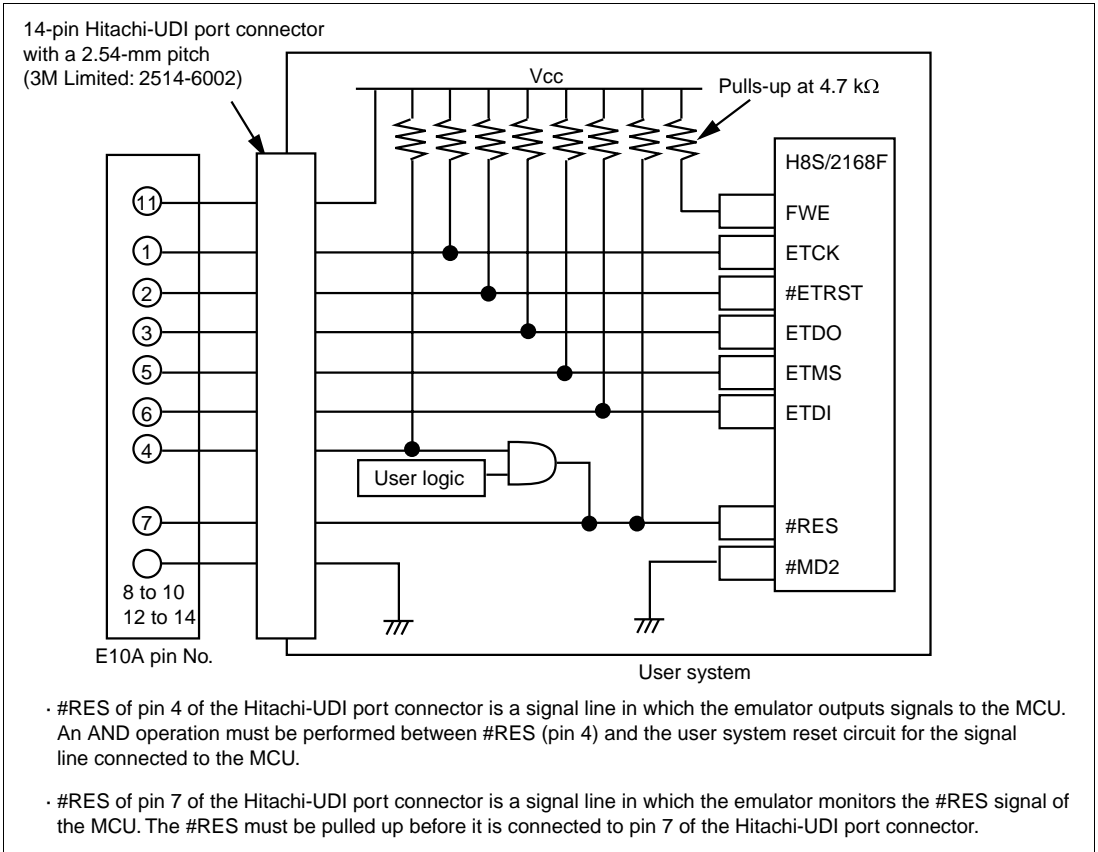
Note that the pin number assignment of the Hitachi-UDI connector differs from that of the connector manufacturer.



**Figure 6.1 Pin Arrangement of the Hitachi-UDI Port Connector (14-Pin Type)**

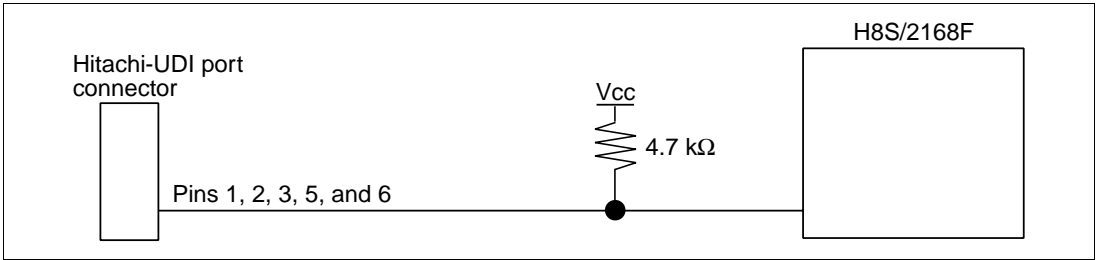
### 6.3 Example of Emulator Connection

The following shows an example of connecting the user system to the emulator.



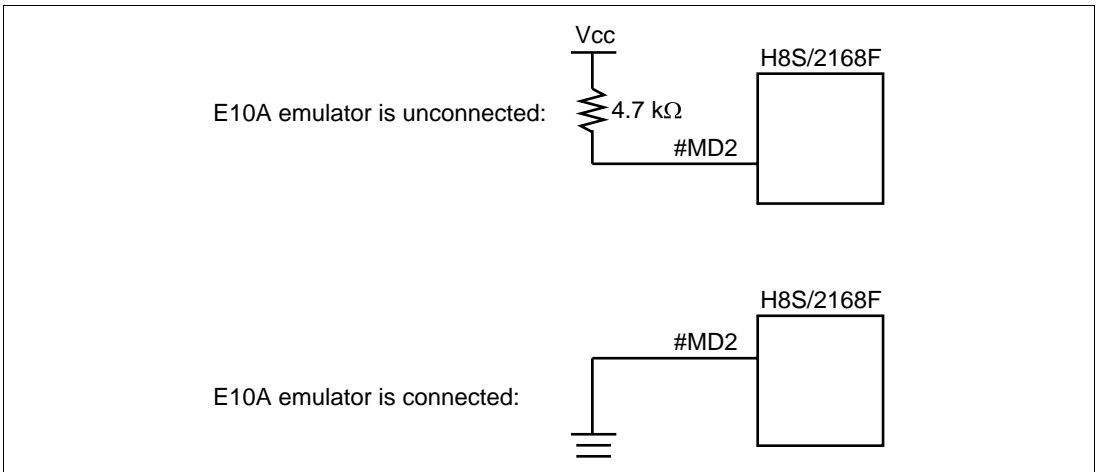
**Figure 6.2 Example of Emulator Connection**

**Notes: 1. The emulator uses #ETRST, ETCK, ETMS, ETDO, and ETDI pins in the H8S/2168F. Pull up the emulator and MCU pins and connect them to the user system connector.**



**Figure 6.3 Connection of Emulator and the MCU**

**2. The #MD2 pin in the H8S/2168F must be pulled up when not connecting with the emulator, and connected to ground when connecting with the emulator.**



**Figure 6.4 #MD2 Pin and Emulator**



- The #RES signal, pin 4 in the Hitachi-UDI port connector, is a signal line that is output for the MCU by the emulator. Connect the AND logic with the reset circuit in the user system to the MCU.  
The #RES signal, pin 7 in the Hitachi-UDI port connector, is a signal line that the emulator monitors the #RES pin in the MCU. Pull up and connect it to pin 7 in the Hitachi-UDI port connector.

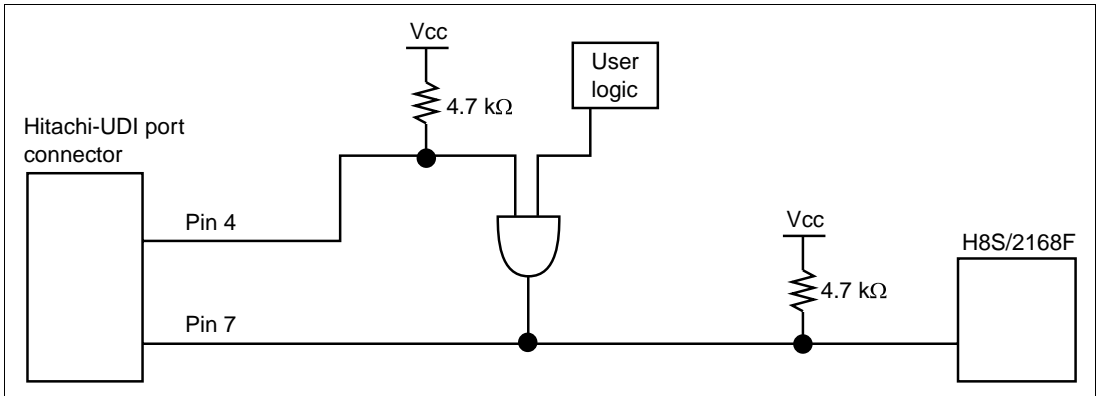


Figure 6.5 Connection of the #RES Pin

- The FWE pin in the H8S/2168F must be pulled up when connecting with the emulator.

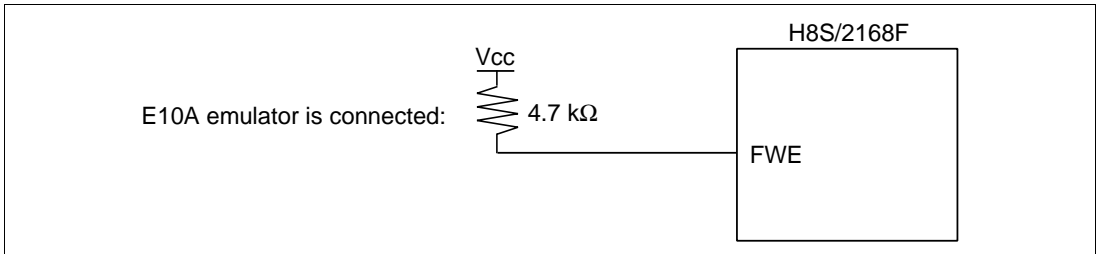


Figure 6.6 Connection of the FWE Pin

- Connect GND of pins 8 to 10 and 12 to 14 in the Hitachi-UDI port connector to ground in the user system.
- Connect Vcc, pin 11 in the Hitachi-UDI port connector, to the power supply (Vcc) in the user system. The input voltage, Vcc, is within the range of guaranteed operation of the microcomputer.

7. Figure 6.7 shows the interface circuit in the emulator. Use this figure as a reference when determining the pull-up resistance value.

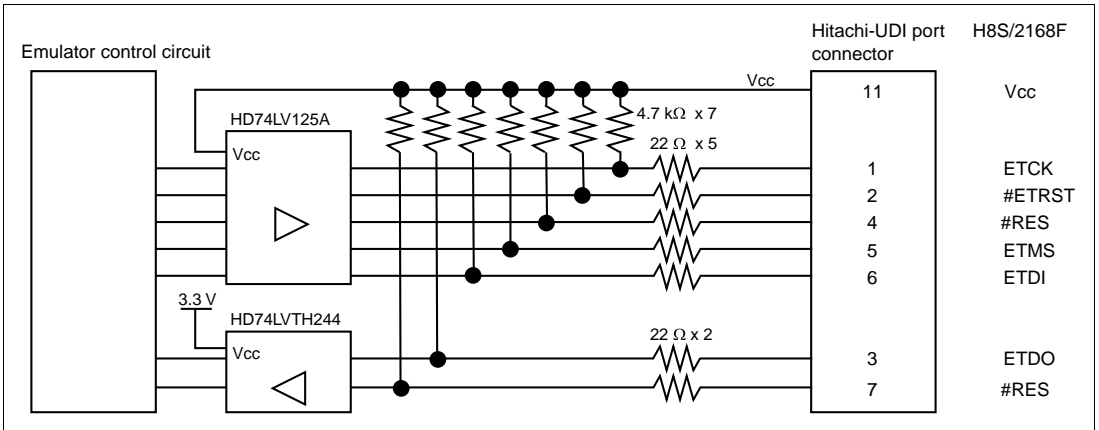


Figure 6.7 Interface Circuit in the Emulator (Reference)

## 6.4 Differences between the H8S/2168F and the Emulator

1. When the emulator system is initiated, it initializes the general registers and part of the control registers as shown in table 6.2.

**Table 6.2 Register Initial Values at Emulator Power-On**

<b>Register</b>	<b>When Using H8S/2168F</b>
PC	Reset vector value in the vector address table
ER0 to ER6	H'0
ER7 (SP)	H'10
CCR	1 for I mask, and others undefined
EXR	H'7F

### 2. System Control Register

In the emulator, the internal I/O registers can be accessed from the [I/O registers] window. However, be careful when accessing the system control register. The emulator saves the register value of the system control register at a break and returns the value when the user program is executed. Since this is done during a break, do not rewrite the system control register in the [I/O Registers] window.

### 3. Memory Access during Emulation

If the memory contents are referenced or modified during emulation, realtime emulation cannot be performed because the user program is temporarily halted.

### 4. The emulator communicates with the H8S/2168F by using the #RES, #ETRST, ETCK, ETMS, ETDO, and ETDI pins. These pins cannot be used.

### 5. The power consumed by the MCU can reach several mA. This is because the user power supply drives one HD74LV125A to make the communication signal level match the user-system power-supply voltage.

## 6.5 The H8S/2168F E10A Emulator Functions

- Notes:
1. Do not use an MCU that has been used for debugging nor that has been written to the flash memory in the E10A.
  2. If the flash memory is rewritten many times, and the emulator is left for a few days, data may be lost due to retention problems.
  3. If the flash memory is rewritten many times, the data will not be erased. If an error message is displayed, exchange the MCU for a new one.

### 6.5.1 Emulator Driver Selection

Table 6.3 shows drivers which can be selected in the [E10A Driver Details] dialog box.

**Table 6.3 Type Name and Driver**

Type Name	Driver
HS2168KCM01H	E10A PC Card Driver 5
HS2168KCI01H	E10A PCI Card Driver 5

### 6.5.2 Hardware Break Functions

**Hardware Break Conditions:** In the H8S/2168F E10A emulator, eight conditions of Break Condition can be set. Table 6.4 lists the items that can be specified.

**Table 6.4 Hardware Break Condition Specification Items**

Items	Description
Address bus condition	Breaks when the MCU address bus value matches the specified value.
Data bus condition	Breaks when the MCU data bus value matches the specified value. High or low byte, or word can be specified as the access data size.
Read or write condition	Breaks in the read or write cycle.

Table 6.5 lists the combinations of conditions that can be set in the [Break condition] dialog box.

**Table 6.5 Conditions Set in [Break condition] Dialog Box**

Dialog Box	Condition		
	Address Bus Condition	Data Condition	Read or write condition
[Break condition 1]	○	○	○
[Break condition 2]	○	○	○
[Break condition 3]	○	×	○
[Break condition 4]	○	×	○
[Break condition 5]	○	×	○
[Break condition 6]	○	×	○
[Break condition 7]	○	×	○
[Break condition 8]	○	×	○

Note: ○: Can be set by checking the radio button in the dialog box.

Table 6.6 lists the combinations of conditions that can be set by the BREAKCONDITION\_SET command.

**Table 6.6 Conditions Set by BREAKCONDITION\_SET Command**

Channel	Condition		
	Address Bus Condition (<addropt> option)	Data Condition (<dataopt> option)	Read or write condition (<r/wopt> option)
Break condition 1	○	○	○
Break condition 2	○	○	○
Break condition 3	○	×	○
Break condition 4	○	×	○
Break condition 5	○	×	○
Break condition 6	○	×	○
Break condition 7	○	×	○
Break condition 8	○	×	○

Note: ○: Can be set by the BREAKCONDITION\_SET command.

## Notes on Setting the Break Condition:

1. When [Go to cursor], [Step In], [Step Over], or [Step Out] is selected, the settings of Break Condition are disabled.
2. The settings of Break Condition is disabled when an instruction to which a software breakpoint has been set is executed.
3. When step over function is used, the settings of software breakpoint and Break Condition are disabled.

### 6.5.3 Notes on Setting the [Breakpoint] Dialog Box

1. When an odd address is set, the address is rounded down to an even address.
2. A software break is accomplished by replacing instructions. Accordingly, it can be set only to the flash memory or RAM area. However, a software break cannot be set to the following addresses:
  - An area other than flash memory or RAM
  - An instruction in which Break Condition is satisfied
3. During step execution, a software breakpoint is disabled.
4. A condition set at Break Condition is disabled immediately after starting execution when an instruction at a software breakpoint is executed. A break does not occur even if a condition of Break Condition is satisfied immediately after starting the execution.
5. When execution resumes from the breakpoint address after the program execution stops at the software breakpoint, single-step execution is performed at the address before execution resumes. Therefore, realtime operation cannot be performed.
6. Settings of software breakpoint and Break Condition are invalid while the STEP OVER function is being used.

### 6.5.4 Note on Using the JTAG Clock (TCK)

When the JTAG clock (TCK) is used, set the frequency to lower than that of the system clock.

### 6.5.5 Trace Function

The trace function in the H8S/2168F E10A emulator uses the branch-instruction trace function in the MCU. It displays the branch-source address or the mnemonic, and operand can be acquired in realtime.

## 6.5.6 Notes on HDI

### 1. Note on Moving Source File Position after Creating Load Module

When the source file is moved after creating the load module, the [Open] dialog box may be displayed to specify the source file during the debugging of the created load module. Select the corresponding source file and click the [Open] button.

### 2. Source-Level Execution

#### — Source file

Do not display source files that do not correspond to the load module in the program window. For a file having the same name as the source file that corresponds to the load module, only its addresses are displayed in the program window. The file cannot be operated in the program window.

#### — Step

Even standard C libraries are executed. To return to a higher-level function, enter Step Out. In a for statement or a while statement, executing a single step does not move execution to the next line. To move to the next line, execute two steps.

### 3. Operation During Accessing Files

Do not perform other operations during saving in the [Load Program], [Verify Memory], [Save Memory], or [Trace] window because this will not allow correct saving to be performed.

### 4. Source Window at Program Change

When a program being displayed in the source window is changed and the source file and load module are reloaded, close and reopen the source window once. If the window is not closed and reopened, the display will be illegal.

### 5. Watch

#### — Local variables at optimization

Depending on the generated object code, local variables in a C source file that is compiled with the optimization option enabled will not be displayed correctly. Check the generated object code by displaying the [Disassembly] window.

If the allocation area of the specified local variable does not exist, displays as follows.

```
Example:      The variable name is asc.  
  
              asc = ? - target error 2010 (xxxx)
```

#### — Variable name specification

When a name other than a variable name, such as a symbol name or function name, is specified, no data is displayed.

Example:           The function name is main.

main =

— Array display

When array elements exceed 1000, elements from after 1000 will not be displayed.

## 6. Memory Load Function

When [Load...] is selected from the [Memory] menu, the Memory Load function can be used although it takes time to download. It is recommended that the File Load function ([Load Program...] selected from the [File] menu) is used to load the S-type file.

Note: The File Load function deletes the debugging information of the previously loaded program. When other load modules are loaded after the program to be debugged has been loaded, use the following sequence: Link the program to be debugged with the Sdebug option and save the debugging information in another file. Load the debugging information file after all the load modules have been loaded.

## 7. Line Assembly

— Input radix

Regardless of the Radix setting, the default for line assembly input is decimal. Specify H' or 0x as the radix for a hexadecimal input.

## 8. Command Line Interface

— Batch file

To display the message “Not currently available” while executing a batch file, enter the sleep command. Adjust the sleep time length which differs according to the operating environment.

Example:           To display “Not currently available” during memory\_fill execution:

```
sleep d'3000
```

```
memory_fill 0 ffff 0
```

— Overwrite file

In Command Line Interface, a file having the same name as the output file is overwritten without asking the user.

— File specification by commands

The current directory may be altered by file specifications in commands. Absolute paths should be used to specify the files in a command file so that the current directory alteration is not affected.



Example: FILE\_LOAD C:\\HEW\\HDI5\\E10A\\2168F\\TUTORIAL  
\\TUTORIAL.ABS

## 9. Note on Initiating HDI

When the emulator is initiated by using another card emulator after it has been initiated by using the PCI card emulator, delete the [TARGET] line from the C:\\windows\\HDI.INI file.

## 10. Usage with Another HDI

— Automatic load of session files

Since the emulator cannot use another HDI, re-install this HDI whenever another HDI has been previously installed is used.

If another HDI has been used, initiate this HDI with “Run” as follows without using the session files.

```
<Directory path name in which HDI is installed>\\hdi /n (RET)
```

/n initiates the HDI without loading the recently used session files.

If there is another session file in the different debug platform, the following error message is displayed:

```
invalid target system: <recently used debug platform name>
```

## 11. [Select Function] dialog box

This HDI does not support software breakpoint setting in the [Select Function] dialog box (described in section 10, Selecting Functions, in the Hitachi Debugging Interface User's Manual).

## 12. Memory Save During User Program Execution

Do not execute memory save verifying during user program execution.

## 13. Loading Motorola S-type files

This HDI does not support Motorola S-type files with only the CR code (H'0D) at the end of each record. Load Motorola S-type files with the CR and LF codes (H'0D0A) at the end of each record.

## 14. [Memory] window

If the following memory contents are displayed, they will be incorrect.

Word access from address  $2n + 1$

Longword access from address  $4n + 1$ ,  $4n + 2$ , or  $4n + 3$

## 15. Scrolling Window During User Program Execution

Do not scroll the [Memory] and [Disassembly] windows by dragging the scroll box during user program execution. This generates many memory reads causing the user program to stop execution until the memory reads have been completed.

## 16. [I/O Registers] window

### — Display and modification

Do not change values in the [I/O Registers] window because the emulator uses the address break controller.

### — Note that the E10A emulator does not support the display of the invalid module or bit information in the [I/O Registers] window (described in section 8, Displaying Variables, in the Hitachi Debugging Interface User's Manual).

### — Verify

In the [I/O Registers] window, the verify function of the input value is invalid.

## 17. Note on [Registers] Window Operation During Program Execution

Although a dialog box is displayed in which the register contents can be changed by double-clicking the [Registers] window, do not change the register contents during program execution.

## 18. Note on Radix in the [Register] Dialog Box

The default input radix in the [Register] dialog box is hexadecimal irrespective of the Radix display. When a radix other than a hexadecimal is input, specify the prefix code such as B'. After the value has been input in the [Register] dialog box, the Radix setting is changed to hexadecimal. When the radix other than a hexadecimal is used as a default, reset the Radix display.

## 19. Software Break

### — Session file

When the software breakpoint address set in the session file is H'0, the breakpoint will not be set. If the address set as the breakpoint is wrong, the error message is not output. The breakpoint is registered as DISABLE in the [Breakpoints] window.

### — [Breakpoints] window

During user program execution, it is impossible to jump from the breakpoint to the source or address line in the [Source] or [Disassembly] window by using [Go to Source] in the popup menu displayed in the [Breakpoints] window.

### — When the software breakpoint is set in the flash memory area, the program is written to the flash memory each time the user program is executed. At this time, note that the number of rewritable times will be decreased.

### — Breakpoint cancellation

When the contents of the software breakpoint address is modified during user program execution, the following message is displayed when the user program stops.

```
BREAKPOINT IS DELETED A=xxxxxxx
```

If the above message is displayed, cancel all software breakpoint settings with the [Delete All] or [Disable] button in the [Breakpoints] window.

## 20. Number of Software Breakpoint and [Stop At] Settings in the [Run...] Menu

The maximum number of software breakpoints and [Stop At] settings allowed in the [Run...] menu is 255. Therefore, when 255 software breakpoints are set, specification by [Stop At] in the [Run...] menu becomes invalid. Use the software breakpoints and [Stop At] in the [Run...] menu with 255 or less total settings.

## 21. Note on RUN-TIME Display

The execution time of the user program displayed in the [Status] window is not a correct value since the timer in the host computer has been used.

## 22. Note on Displaying COMMUNICATION TIMEOUT ERROR

If COMMUNICATION TIMEOUT ERROR is displayed, the emulator cannot communicate with the MCU. Select [Initialize] from the [File] menu to initialize the emulator.

## 23. Note on Downloading Program

In the [Load Program] dialog box, which is opened when [Load Program...] is selected, the verify function is invalid. After downloading the program, perform verify in the [Verify S-Record File with Memory] dialog box, which is opened when [Verify] is selected from the [Memory] menu.

## 24. Note on Using Old Version of Windows® 95

In using the old released version of Windows® 95 (such as 4.00.950a), if [Options...] is selected from the [Setup] menu, an application error occurs and the HDI abnormally exits. This is due to the old version of COMCTL32.DLL in the System directory of the Windows directory. Download the update program of COMCTL32.DLL from the Microsoft® homepage for installation, or update the version of Windows® 95.

## 25. Support of Double Float Format

In the following memory operations, the double float format is not supported:

- [Fill Memory] dialog box
- [Search Memory] dialog box
- MEMORY\_FILL command

The [Format] specification in the [Copy Memory] dialog box is ignored. Memory is copied in a byte unit.

- Double float display at little endian operation

## 26. Note on Continuous Step Execution

When the step is continuously executed by selecting [Step...] from the [Run] menu, do not use the software breakpoint because this will cause the HDI to abnormally operate.

## 27. Note on Using the [Run program] Dialog Box

When [Run...] is selected from the [Run] menu to specify the stop address, there is the following note:

— When the breakpoint that has been set as Disable is specified as the stop address, note that the breakpoint becomes Enable when the user program stops.

## 28. Processing Time for Updating the Flash Memory Contents

When the contents of the flash memory area is modified by the program loading, memory window, or memory command, or when a software break is set, a waiting time will be generated to write or read the flash memory before executing the user program.

The processing time for updating the flash memory contents will be about a maximum of 30 seconds under the following environments (reference values):

Host computer: 700 MHz (Celeron®)

H8S/2168F: 25 MHz (system clock frequency)

## 29. Note on Programming the Flash Memory

No break processing is performed while the processing routine is being executed to program or erase the flash memory.