

IMPORTANT INFORMATION

READ FIRST

- **READ this user's manual before using this user system interface cable.**
- **KEEP the user's manual handy for future reference.**

Do not attempt to use the user system interface cable until you fully understand its mechanism.

User System Interface Cable:

Throughout this document, the term "user system interface cable" shall be defined as the following product produced only by Renesas Technology Corp. excluding all subsidiary products.

- User system interface cable (HS2214ECB62H)

The user system or a host computer is not included in this definition.

Purpose of the User System Interface Cable:

This user system interface cable is for connecting the emulator station and user system. This user system interface cable must only be used for the above purpose.

Improvement Policy:

Renesas Technology Corp. (including its subsidiaries, hereafter collectively referred to as Renesas) pursues a policy of continuing improvement in design, performance, functions, and safety of the user system interface cable. Renesas reserves the right to change, wholly or partially, the specifications, design, user's manual, and other documentation at any time without notice.

Target User of the User System Interface Cable:

This user system interface cable should only be used by those who have carefully read and thoroughly understood the information and restrictions contained in the user's manual. Do not attempt to use the user system interface cable until you fully understand its mechanism.

It is highly recommended that first-time users be instructed by users that are well versed in the operation of the user system interface cable.

LIMITED WARRANTY

Renesas warrants its user system interface cables to be manufactured in accordance with published specifications and free from defects in material and/or workmanship. Renesas will repair or replace any user system interface cables determined to be defective in material and/or workmanship. User system interface cables are wearing parts which Renesas will not repair or replace if damaged and/or worn through use. The foregoing shall constitute the sole remedy for any breach of Renesas' warranty. This warranty extends only to you, the original Purchaser. It is not transferable to anyone who subsequently purchases the user system interface cable from you. Renesas is not liable for any claim made by a third party or made by you for a third party.

DISCLAIMER

RENESAS MAKES NO WARRANTIES, EITHER EXPRESS OR IMPLIED, ORAL OR WRITTEN, EXCEPT AS PROVIDED HEREIN, INCLUDING WITHOUT LIMITATION THEREOF, WARRANTIES AS TO MARKETABILITY, MERCHANTABILITY, FITNESS FOR ANY PARTICULAR PURPOSE OR USE, OR AGAINST INFRINGEMENT OF ANY PATENT. IN NO EVENT SHALL RENESAS BE LIABLE FOR ANY DIRECT, INCIDENTAL OR CONSEQUENTIAL DAMAGES OF ANY NATURE, OR LOSSES OR EXPENSES RESULTING FROM ANY DEFECTIVE USER SYSTEM INTERFACE CABLE, THE USE OF ANY USER SYSTEM INTERFACE CABLE, OR ITS DOCUMENTATION, EVEN IF ADVISED OF THE POSSIBILITY OF SUCH DAMAGES. EXCEPT AS EXPRESSLY STATED OTHERWISE IN THIS WARRANTY, THIS USER SYSTEM INTERFACE CABLE IS SOLD "AS IS", AND YOU MUST ASSUME ALL RISK FOR THE USE AND RESULTS OBTAINED FROM THE USER SYSTEM INTERFACE CABLE.

State Law:

Some states do not allow the exclusion or limitation of implied warranties or liability for incidental or consequential damages, so the above limitation or exclusion may not apply to you. This warranty gives you specific legal rights, and you may have other rights which may vary from state to state.

The Warranty is Void in the Following Cases:

Renesas shall have no liability or legal responsibility for any problems caused by misuse, abuse, misapplication, neglect, improper handling, installation, repair or modifications of the user system interface cable without Renesas' prior written consent or any problems caused by the user system.

All Rights Reserved:

This user's manual and user system interface cable are copyrighted and all rights are reserved by Renesas. No part of this user's manual, all or part, may be reproduced or duplicated in any form, in hard-copy or machine-readable form, by any means available without Renesas' prior written consent.

Other Important Things to Keep in Mind:

1. Circuitry and other examples described herein are meant merely to indicate the characteristics and performance of Renesas' semiconductor products. Renesas assumes no responsibility for any intellectual property claims or other problems that may result from applications based on the examples described herein.
2. No license is granted by implication or otherwise under any patents or other rights of any third party or Renesas.

Figures:

Some figures in this user's manual may show items different from your actual system.

Limited Anticipation of Danger:

Renesas cannot anticipate every possible circumstance that might involve a potential hazard. The warnings in this user's manual and on the user system interface cable are therefore not all inclusive. Therefore, you must use the user system interface cable safely at your own risk.

SAFETY PAGE

READ FIRST

- **READ** this user's manual before using this user system interface cable.
- **KEEP the user's manual handy for future reference.**

Do not attempt to use the user system interface cable until you fully understand its mechanism.

DEFINITION OF SIGNAL WORDS



This is the safety alert symbol. It is used to alert you to potential personal injury hazards. Obey all safety messages that follow this symbol to avoid possible injury or death.



DANGER indicates an imminently hazardous situation which, if not avoided, will result in death or serious injury.



WARNING indicates a potentially hazardous situation which, if not avoided, could result in death or serious injury.



CAUTION indicates a potentially hazardous situation which, if not avoided, may result in minor or moderate injury.



CAUTION used without the safety alert symbol indicates a potentially hazardous situation which, if not avoided, may result in property damage.

NOTE emphasizes essential information.

WARNING

Observe the precautions listed below. Failure to do so will result in a FIRE HAZARD and will damage the user system and the emulator product or will result in PERSONAL INJURY. The USER PROGRAM will be LOST.

- 1. Do not repair or remodel the emulator product by yourself for electric shock prevention and quality assurance.**
- 2. Always switch OFF the E6000 emulator and user system before connecting or disconnecting any CABLES or PARTS.**
- 3. Always before connecting any CABLES, make sure that pin 1 on both sides are correctly aligned.**

Preface

Thank you for purchasing this user system interface cable (HS2214ECB62H) for the Renesas' original microcomputer H8S/2214 group.

The HS2214ECB62H is a user system interface cable that connects an H8S/2214 group E6000 emulator (HS2214EPI62H; hereinafter referred to as the emulator) to the IC socket for a BP-112 package for the H8S/2214 group MCU on the user system.

Contents

Section 1	Configuration.....	1
Section 2	Connection Procedures	3
2.1	Connecting User System Interface Cable to Emulator Station	3
2.2	Connecting User System Interface Cable to User System	5
2.2.1	Soldering the IC Socket	5
2.2.2	Inserting Cable Head	8
2.2.3	Fastening Cable Head	9
2.2.4	Fastening Cable Body	11
2.3	Recommended Dimensions for User System Mount Pad	12
2.4	Dimensions for User System Interface Cable Head.....	13
2.5	Resulting Dimensions after Connecting User System Interface Cable	14
Section 3	Installing the MCU to the User System.....	15
Section 4	Verifying Operation.....	17
Section 5	Notice	18

Section 1 Configuration

CAUTION

Use an CSPACK112A1110H02 socket (socket manufactured by Tokyo Eletech Corporation) for the BP-112 package IC socket on the user system.

Figure 1 shows the configuration of the HS2214ECB62H user system interface cable for the BP-112 package.

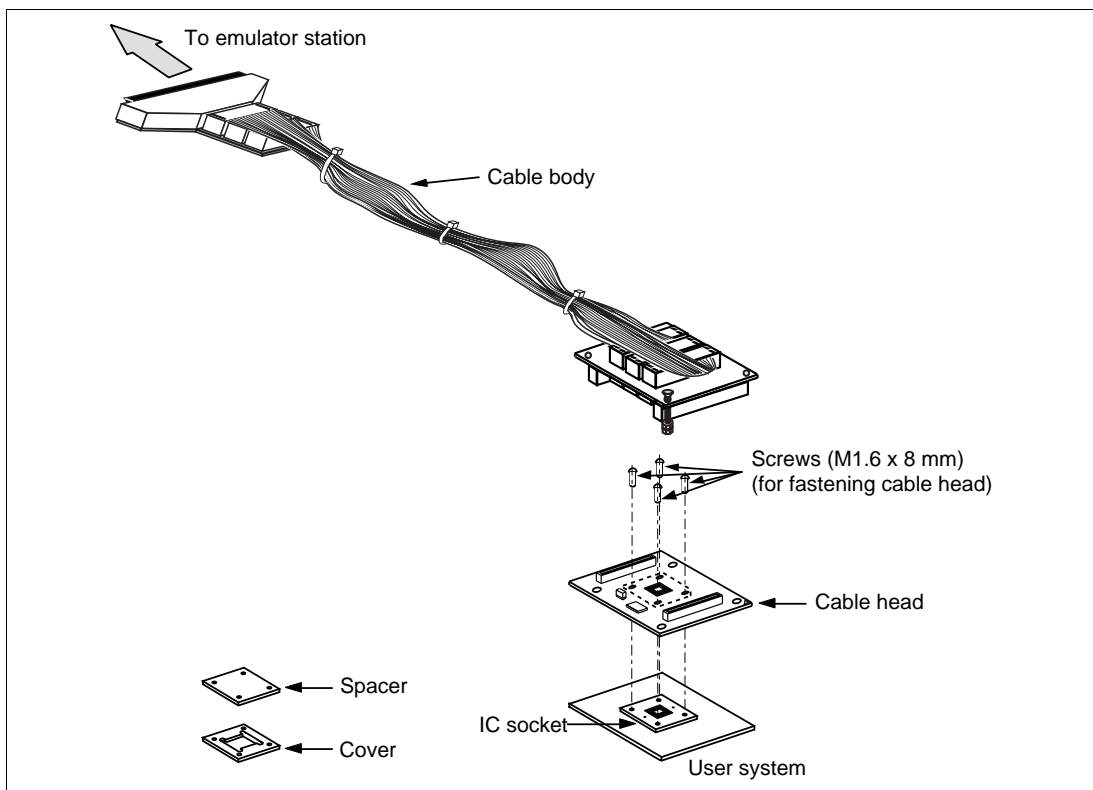

Figure 1 HS2214ECB62H User System Interface Cable

Table 1 lists the HS2214ECB62H components. Please make sure you have all of these components when unpacking.

Table 1 HS2214ECB62H Components

No.	Component	Quantity	Remarks
1	Cable body	1	Includes flat cable
2	Cable head	1	
3	IC socket	1	For the BP-112 package
4	Spacer	1	For installing a BP-112 packaged MCU
5	Cover	1	For installing a BP-112 packaged MCU
6	Screws (M1.6 x 8 mm)	4	For fastening cable head and for installing a BP-112 packaged MCU
7	Driver	1	Screwdriver dedicated for fastening the screws.
8	Documentation	1	User's manual for HS2214ECB62H (this manual)

Section 2 Connection Procedures

2.1 Connecting User System Interface Cable to Emulator Station

WARNING

Observe the precautions listed below. Failure to do so will result in a FIRE HAZARD and will damage the user system and the emulator product or will result in PERSONAL INJURY. The USER PROGRAM will be LOST.

- 1. Always switch OFF the user system and the emulator product before the USER SYSTEM INTERFACE CABLE is connected to or removed from any part. Before connecting, make sure that pin 1 on both sides are correctly aligned.**
- 2. The user system interface cable dedicated to the emulator must be used.**

To connect the cable body to the emulator station, follow the instructions below.

1. Make sure the user system and emulator station are turned off.

CAUTION

When connecting or removing the user system interface cable, apply force only in the direction suitable for connection or removal, while making sure not to bend or twist the cable or connectors. Otherwise, the connectors will be damaged.

2. After making sure the direction of the cable body connector is correct, firmly insert the cable body connector into the emulator station socket (figure 2).

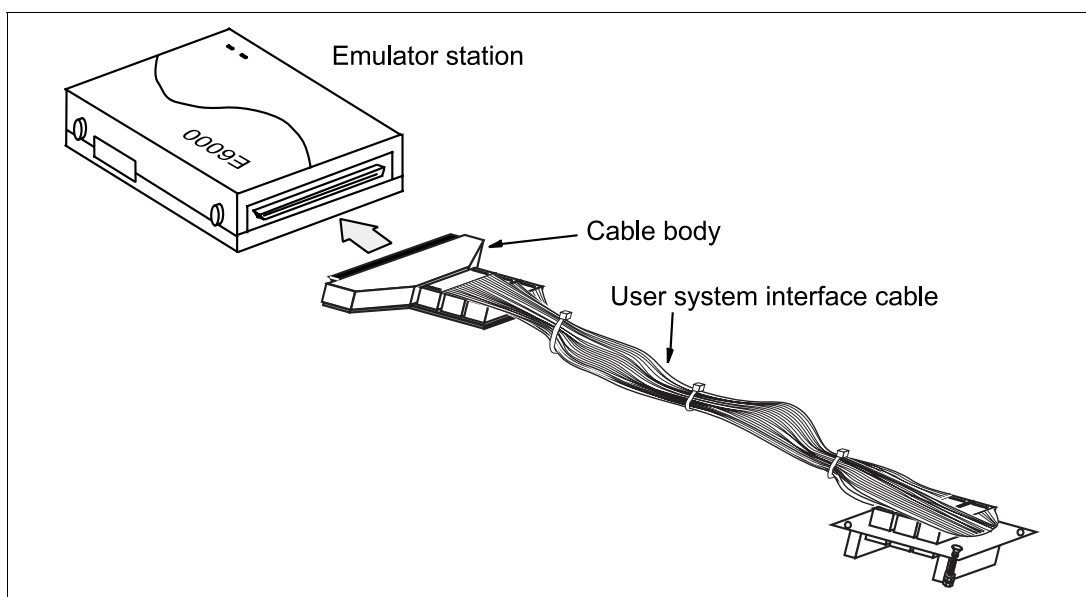

Figure 2 Connecting User System Interface Cable to Emulator Station

2.2 Connecting User System Interface Cable to User System

WARNING

Always switch OFF the user system and the emulator product before the USER SYSTEM INTERFACE CABLE is connected to or removed from any part. Before connecting, make sure that pin 1 on both sides are correctly aligned. Failure to do so will result in a FIRE HAZARD and will damage the user system and the emulator product or will result in PERSONAL INJURY. The USER PROGRAM will be LOST.

To connect the cable head to the user system, follow the instructions below.

2.2.1 Soldering the IC Socket

Install the socket for BP-112-packaged ICs on the user system.

- (1) Gently apply solder to the BGA pads of the user system. Be careful to keep the thickness of the solder within 100 to 150 μm . Too much solder will cause short-circuiting of the pins.
- (2) The IC socket is vacuum-packed to avoid oxidization of the surfaces of the solder balls. It is thus recommended that the IC socket be installed on the user system if you do not install the socket immediately after the package it comes in is opened. After the package's seal has been broken, store the socket in a desiccator. Do not touch the solder balls. If they are touched, solder may not adhere to the solder surface.
The IC socket is covered by a protective cover. Socket and cover are fastened together by four screws before the whole is vacuum packed to prevent bending of the IC socket's pins. To avoid the scattering (dispersal) of flux from other components to the IC socket, keep the protective cover on the IC socket until solder reflow has been completed.
- (3) Install the provided guide pins into the holes for the guide pins on the user system. Check that the pads are correctly aligned with the IC socket.

(4) Notes on soldering the IC socket

- a) The IC socket is larger than the actual IC package; therefore, refer to figure 7 for the installation of other components.
- b) Do not install components that occupy large volume close to the IC socket. Such components will prevent the convective flow of heat during reflow.
- c) Since the IC socket has a greater volume than the IC package, it is recommended that the temperature profile under the conditions used in installation be measured by attaching a temperature sensor to the back of the IC socket.
- d) Under the reflow conditions for soldering the IC socket, specify the actual heating to more than 210°C for 30 to 60 seconds.

Recommended Reflow Conditions

Surface temperature of IC-socket connector
Preheating: 150 to 180°C for 180 seconds
Actual heating: To more than 210°C, for 30 to 60 seconds

CAUTION

- 1. Never dip the IC socket in flux or use wash to clean the IC socket. This is because flux may remain inside the IC socket due to the IC socket's structure. When using the IC socket with other DIP products, never clean the other DIP products with flux because the flux may enter the connector through the guide pins of the IC socket.**
- 2. When an IC socket with guide pins is soldered to the user system, about 1.4 mm of the guide pins will stick out (when the user-system board is 1.6 mm thick). When a load is applied to the guide pins from the back of the user-system board, stress will be applied to the soldered part of the IC socket, and this may destroy the connectors. Do not apply any load to the guide pins after the IC socket has been soldered on the user system.**
- 3. When an IC socket with no guide pins is soldered to the user system, the soldered part will crack if stress is applied to the IC socket. Therefore, always apply adhesive to the connector and the user system so that there is a firm connection between them.**
- 4. When the IC socket has guide pins, it is recommended that epoxy resin adhesive or solder be applied to the guide pins at the back of the user system to make sure that no stress is applied to the soldered part.**

2.2.2 Inserting Cable Head

CAUTION

Check the location of pin 1 before inserting.

Align pin 1 on the IC socket for a BP-112 package on the user system with pin 1 on the user system interface cable head, and insert the user system interface cable head into the IC socket on the user system, as shown in figure 3.

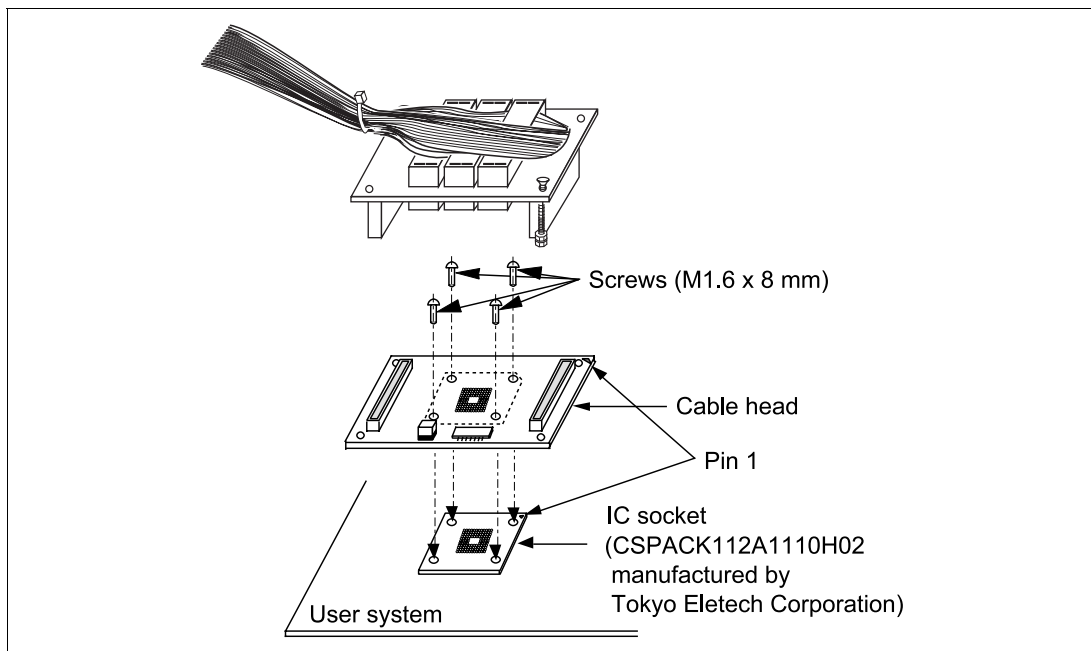

Figure 3 Connecting User System Interface Cable to User System

2.2.3 Fastening Cable Head

CAUTION

1. Use the screwdriver whose head matches the screw head.
2. The tightening torque must be 0.054 N•m or less.
If the applied torque cannot be accurately measured, stop tightening when the force required to turn the screw becomes significantly greater than that needed when first tightening. If a screw is tightened too much, the screw head may break or an IC socket contact error may be caused by a crack in the IC socket solder.
3. If the emulator does not operate correctly, cracks might have occurred in the solder.

The user system interface cable (HS2214ECB62H) head and the IC socket for the BP-112 package on the user system have no pin dedicated for alignment. Use the follow procedure to fasten the cable head.

1. Insert two screws (M1.6 × 8 mm) to ① and ③, and screw it a little so that holes at ②-②' and ④-④' match, respectively.

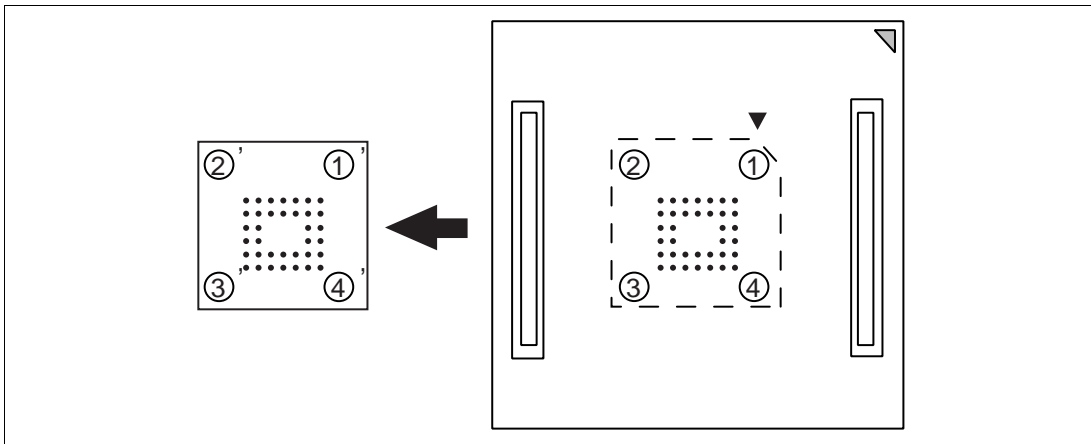

Figure 4 Fastening Cable Head Procedure (1)

2. Fasten screws to ② and ④ a little, so that four screw holes are aligned. Then, each screw should be tightened a little at a time, alternating between screws on opposing corners.

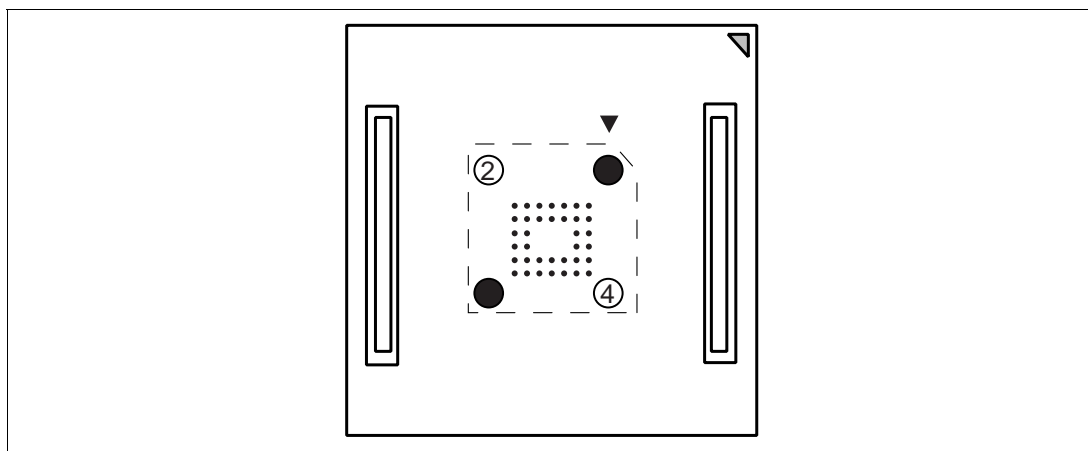

Figure 5 Fastening Cable Head Procedure (2)

2.2.4 Fastening Cable Body

Connect the cable body to the cable head.

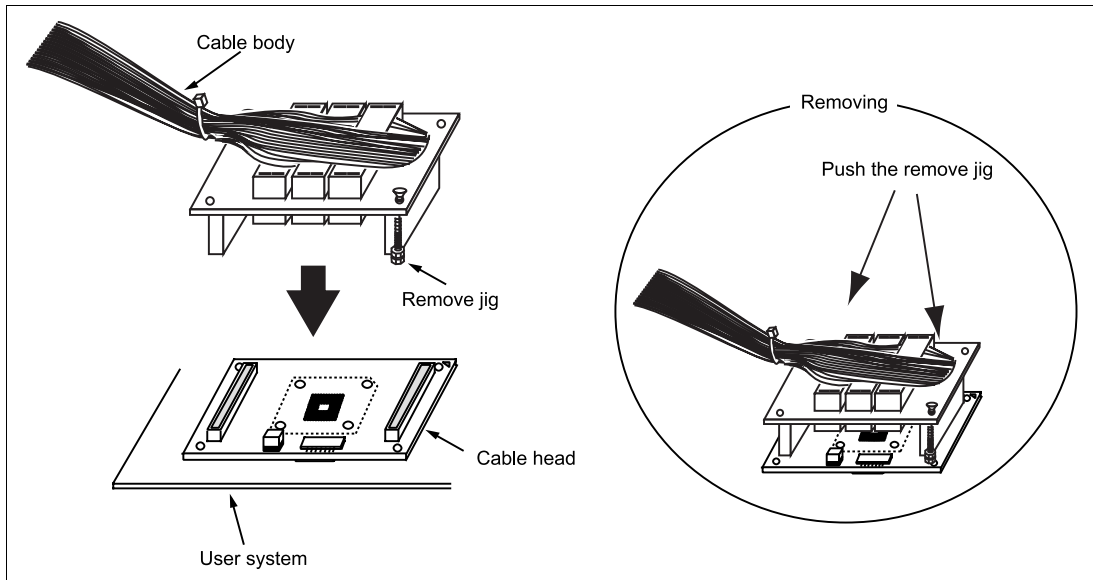

Figure 6 Fastening Cable Body

2.3 Recommended Dimensions for User System Mount Pad

Figure 7 shows the recommended dimensions for the mount pad (footprint) for the user system with an IC socket for a BP-112 package (CSPACK112A1110H02: socket (manufactured by Tokyo Eletech Corporation)). Note that the dimensions in figure 7 are somewhat different from those of the actual chip's mount pad.

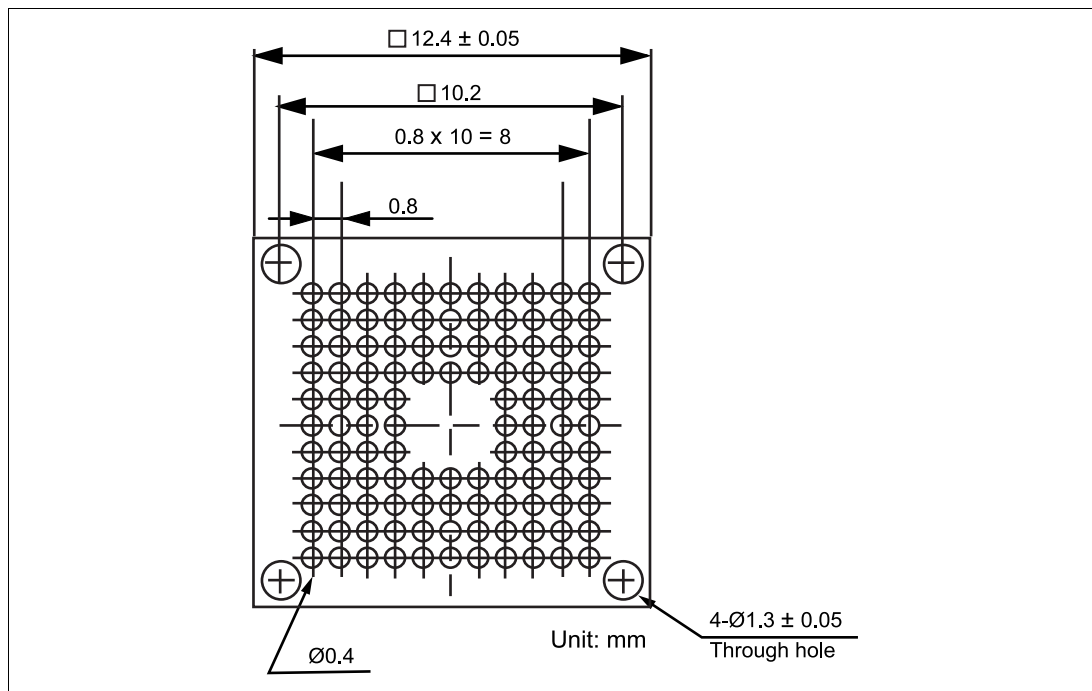

Figure 7 Recommended Dimensions for Mount Pad

2.4 Dimensions for User System Interface Cable Head

The dimensions for the user system interface cable head are shown in figure 8.

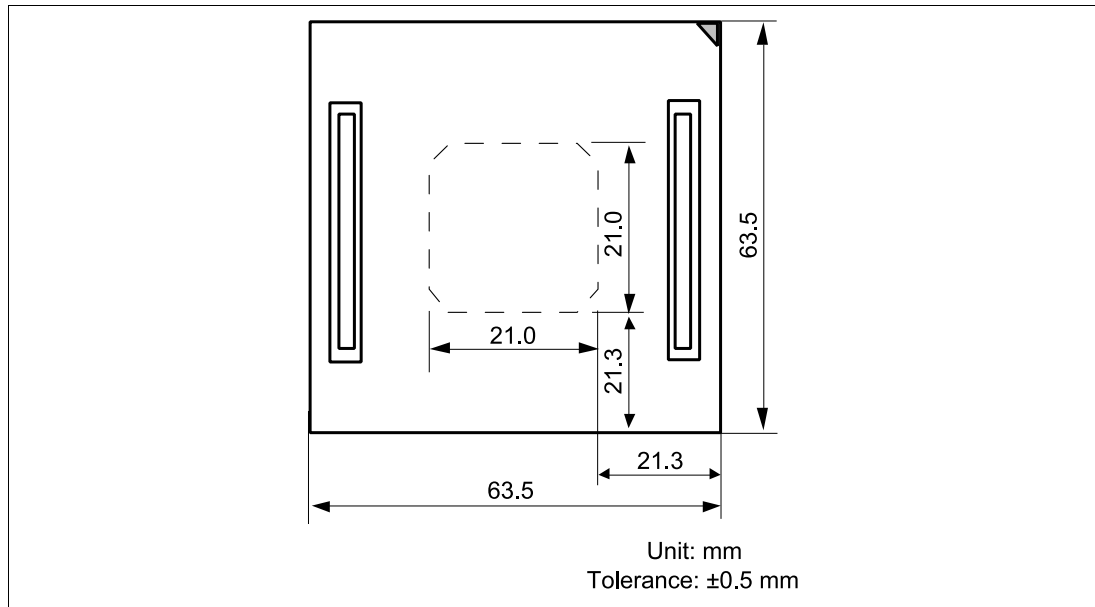

Figure 8 Dimensions for User System Interface Cable Head

2.5 Resulting Dimensions after Connecting User System Interface Cable

The resulting dimensions, after connecting the user system interface cable head to the user system, are shown in figure 9.

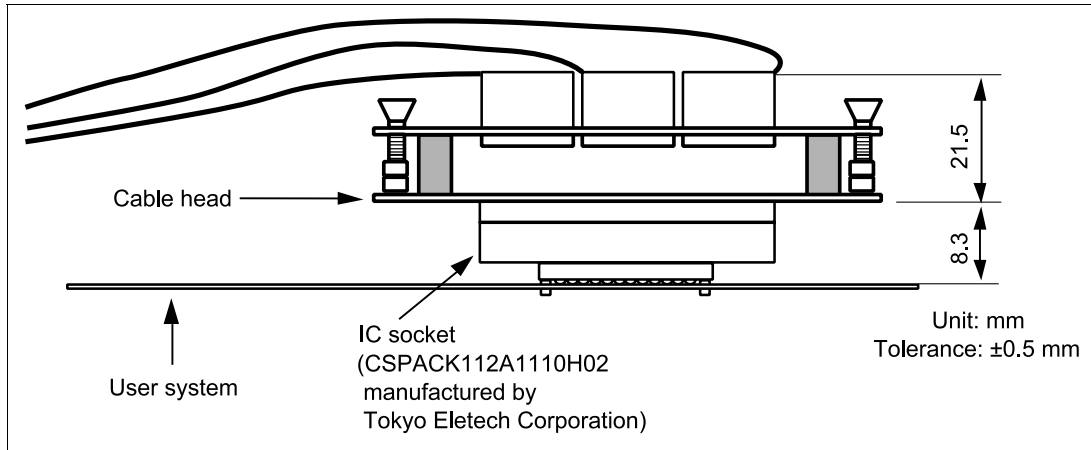

Figure 9 Resulting Dimensions after Connecting User System Interface Cable

Section 3 Installing the MCU to the User System

CAUTION

- 1. Check the location of pin 1 before inserting.**
- 2. Use a provided screwdriver.**
- 3. The tightening torque must be 0.054 N•m or less.
If the applied torque cannot be accurately measured, stop tightening when the force required to turn the screw becomes significantly greater than that needed when first tightening. If a screw is tightened too much, the screw head may break or an IC socket contact error may be caused by a crack in the IC socket solder.**
- 4. If the MCU does not operate correctly, cracks might have occurred in the solder.**

1. Attach the spacer and cover to the IC socket.
2. Place the spacer on the IC socket. Place the two guide pins of the spacer in the corresponding holes on the IC socket.
3. Place the MCU gently in the opening of the spacer. Be sure to correctly align pin 1 of the MCU with the IC socket. The solder balls of the MCU will then be in the correct locations relative to the connection pins of the IC socket.
4. Put the cover on the spacer. The four holes at the four corners of the spacer and of the cover must be aligned. Use the four screws to fasten the cover to the IC socket. Each screw in turn should be made a little tighter, alternating between screws on opposing corners. Use the screwdriver provided with the package. The torque in tightening must be 0.054 N•m or less.
5. When removing the cover from the IC socket, hold the side of the cover so that no stress is applied to the soldered connections between the IC socket and user system while the screws on the cover are being unscrewed. Use tweezers to remove the MCU from the opening in the spacer.

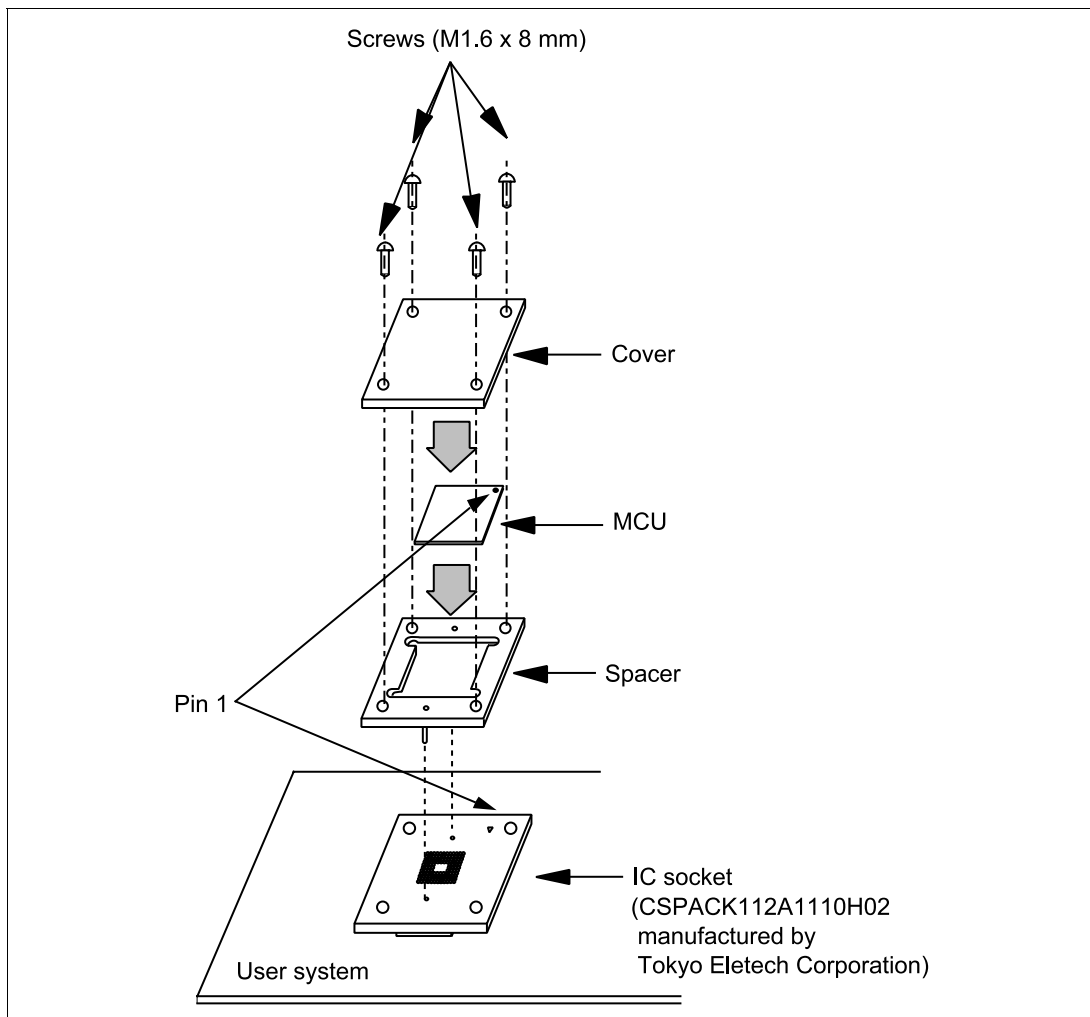

Figure 10 Installing MCU to User System

Section 4 Verifying Operation

1. When using the E6000 emulator for the H8S/2214 group, turn on the emulator according to the procedures described in the H8S Series E6000 Emulator User's Manual (HS2000EPI61HE).
2. Verify the user system interface cable connections by accessing the external memory and ports to check the bus states of the pins with the MEMORY_FILL command (emulator command). If an error is detected, recheck the soldered IC socket and the location of pin 1.
3. The emulator connected to this user system interface cable supports two kinds of clock sources as the MCU clock: an emulator internal clock and an external clock on the user system. For details, refer to the Emulator Supplementary Information (HS2214EPI62HE).
 - To use the emulator internal clock
Select the clock in the emulator station as the system clock (ϕ), by using the CLOCK command (emulator command).
 - To use the external clock on the user system
Supply the external clock from the user system to the emulator. Connect a crystal oscillator to the EXTAL and XTAL terminals for the system clock (ϕ). Select the external clock as the system clock (ϕ), by using the CLOCK command (emulator command). For details, refer to the section of Clock Pulse Generator in the H8S/2214 Group Hardware Manual.

Figure 11 shows the oscillator circuit on the user system interface cable.

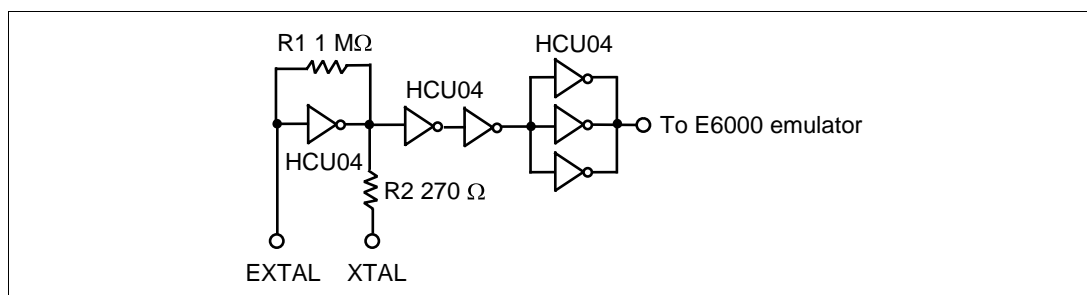

Figure 11 Oscillator Circuit

Section 5 Notice

1. Make sure that pin 1 on the user system IC socket is correctly aligned with pin 1 on the cable head before inserting the cable head into the user system IC socket.
2. The dimensions of the recommended mount pad for the user system IC socket are different from those of the MCU.
3. This user system interface cable is specifically designed for the HS2214EPI62H emulator. Do not use this cable with any other emulator station.
4. To prevent breaking of wires in the cable body, do not place heavy or sharp metal objects on the user system interface cable.
5. While the emulator station is connected to the user system with the user system interface cable, force must not be applied to the cable head. Place the emulator station, user system interface cable, and user system as shown in the example in figure 12.

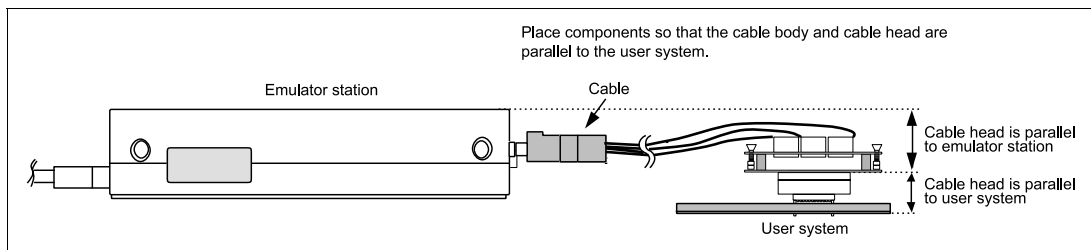

Figure 12 User System Interface Cable Location Example

6. The P1 short connector is used for testing. Do not remove the short pin that is inserted in the side of pin 1 and pin 2.

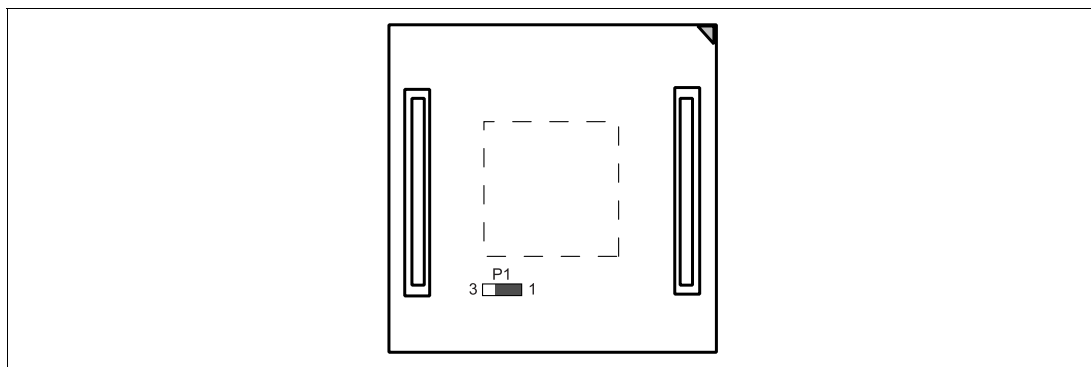

Figure 13 Short Connector