

REVISION AQ

DIMENSIONS ARE IN INCHES UNLESS OTHERWISE NOTED TOLERANCES ARE:
 ONE PLACE DECIMALS: .1 [2.54] THREE PLACE DECIMALS: .005 [.127]
 TWO PLACE DECIMALS: .01 [.254] FOUR PLACE DECIMALS: .0020 [.0508]

TITLE: 2 mm EJECTOR HEADER ASSEMBLY
 ANGLES: ± 2°
 DWG NO: EHT-1XX-01-XX-0-XX-XX-X-XX-XX
 SHEET 1 OF 2

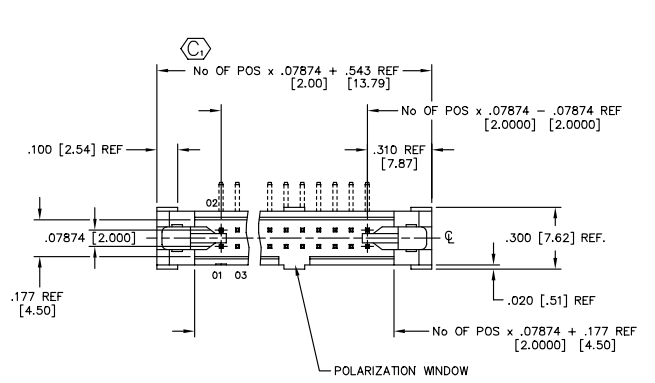

EHT-1XX-01-XX-D-XX-XX-X-XX-XX

NO. OF POSITIONS
 -05 THRU -25

LEAD STYLE
 -01

PLATING SPECIFICATION
 -S: SELECTIVE GOLD (USE T-1S13-XX-S-2)
 -F: FLASH SELECTIVE GOLD (USE T-1S13-XX-F-2)
 -T: TIN (USE T-1S13-XX-T-2)
 -H: HEAVY GOLD (USE T-1S13-XX-H-2)
 -SM: SELECTIVE GOLD, MATTE TIN TAIL (USE T-1S13-XX-S-2)
 -FM: FLASH SELECTIVE GOLD, MATTE TIN TAIL (USE T-1S13-XX-F-2)
 -TM: MATTE TIN (USE T-1S13-XX-T-2)

ROW SPECIFICATION
 -D: DOUBLE

TAIL OPTION
 -RA= RIGHT ANGLE (USE EHH-XX-D)
 -SM= SURFACE MOUNT (USE EHH-XX-D) (LEAVE BLANK FOR THROUGH HOLE)

OPTION 3
 -TR: TAPE & REEL PACKAGING (FOR -SM, -SM-P, AND -SM-K ONLY)

OPTION 2
 -LC: LOCKING CLIP (FOR -SM ONLY) (SEE FIG. 4, USE LC-09-TM)

OPTION 1
 -P: PICK & PLACE PAD (FOR -SM ONLY, USE PPP-24) (USE PPP-55 WITH -SM-TR OPTION)
 -K: OPTION (POLYIMIDE FILM PAD) (FOR -SM ONLY)

POLARIZED OPTION
 -XX= PIN OMITTED

TABLE 2

PIN	OAL
T-1S13-05-XX-2	.397 [1.52±.25]
T-1S13-06-XX-2	.555 [2.00±.13]
T-1S13-15-XX-2	.714 [2.00±.13]

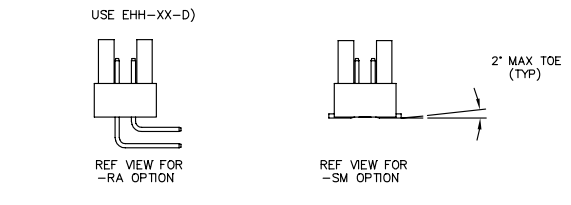
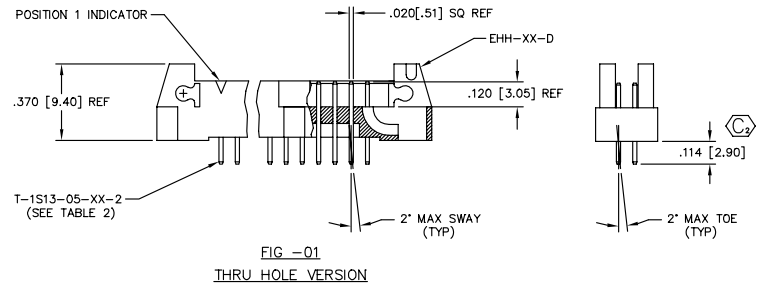

- NOTES:
1. MAX PIN ROTATION IN BODY: 2°.
 2. PUSHOUT FORCE: 1 LB MINIMUM.
 3. DIMENSIONS IN [] ARE IN MILLIMETERS.
 4. (C) REPRESENTS A CRITICAL DIMENSION.

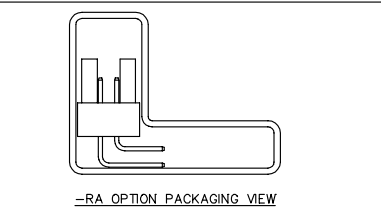
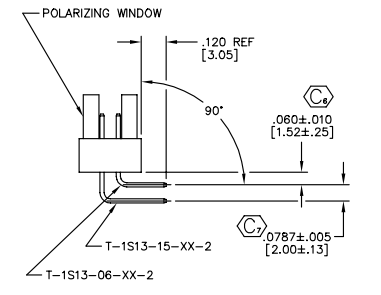
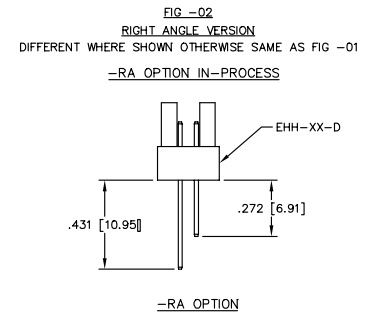

PACKAGING TUBE INSTRUCTIONS

TABLE 1

STYLE	TUBE	PLUG
STRAIGHT	PT-1-24-16-29	TP-13
RIGHT ANGLE	ASP-90341-01-S	TP-13
SURFACE MOUNT	PT-1-24-01-44	TP-13

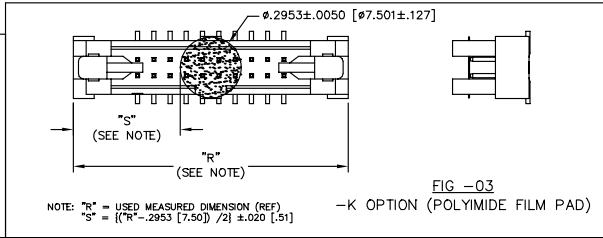
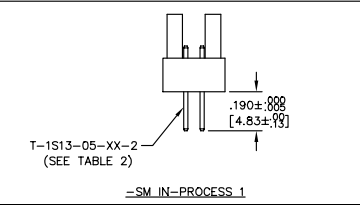
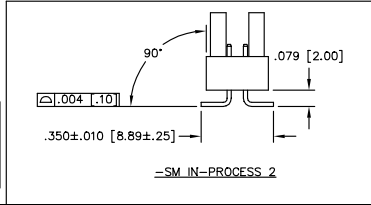

MATERIAL: LIQUID CRYSTAL POLYMER
 COLOR: BLACK
 TERMINAL: PHOSPHOR BRONZE

EXSPEED ASSEMBLY 2MM EHT-ASM

samtec

520 PARK EAST BLVD., NEW ALBANY, INDIANA 47150
 PHONE (812) 944-4733, P.O. BOX 1147
 CODE 55322

MADE BY: PURVIS 2-28-94 APPROVAL: GR
 CHECKED BY: REIDINGER 8-16-94

EHT-1XX-01-XX-0-XX-XX-X-XX-XX

PROPRIETARY NOTE
 THIS DOCUMENT CONTAINS INFORMATION CONFIDENTIAL AND PROPRIETARY TO SAMTEC AND SHALL NOT BE REPRODUCED OR TRANSMITTED IN ANY FORM OR BY ANY MEANS, ELECTRONIC OR MECHANICAL, INCLUDING PHOTOCOPYING, RECORDING, OR BY ANY INFORMATION STORAGE AND RETRIEVAL SYSTEM, WITHOUT THE WRITTEN CONSENT OF SAMTEC INC.