

EE-SPY311/411/312/412

Accurately Detects Objects Placed in Front of Mirror-like Background

- A mirror-like background can be used when the distance between the sensor and the background is 20 mm or more
- Detects an object as small as a 0.05-mm-dia. pure copper wire
- Detects dark-colored objects
- Light modulation effectively reduces external light interference
- Convert to PNP output with EE-2002 conversion connector



Ordering Information

Appearance	Sensing method	Sensing distance	Output configuration	Weight	Part number
	Diffuse (Convergent)	2 to 6 mm (rated sensing distance: 5 mm)	Dark-ON	Approx. 2.6 g	EE-SPY311
			Light-ON		EE-SPY411
5 mm		Dark-ON	EE-SPY312		
		Light-ON	EE-SPY412		

■ ACCESSORIES

Name	Part number
Solder connector	EE-1001
Connector with 2 m cable	EE-1006

Specifications

■ RATINGS

Item		EE-SPY311	EE-SPY411	EE-SPY312	EE-SPY412
Supply voltage		5 to 24 VDC $\pm 10\%$, ripple (p-p): 5% max.			
Current consumption		Average: 15 mA max.; Peak: 50 mA max.			
Rated sensing distance		2 to 6 mm (rated sensing distance: 5 mm, reflection factor: 90%; white paper: 15 x 15 mm)			
Differential distance		0.2 mm (with a sensing distance of 3 mm, horizontally)			
Control output		At 5 to 24 VDC: 80-mA load current (I_C) with a residual voltage of 1.0 V max. When driving TTL: 10-mA load current (I_C) with a residual voltage of 0.4 V max.			
Output configuration	Transistor on output stage without detecting object	ON	OFF	ON	OFF
	Transistor on output stage with detecting object	OFF	ON	OFF	ON
Indicator	Without detecting object	OFF			
	With detecting object	ON			
Response frequency*		100 Hz			
Minimum detectable object		Pure copper wire (0.05 mm dia.)			
Possible background		Glass with aluminum deposition located 20 mm minimum from sensor			
Connecting method		Applicable connectors: EE-1001, EE-1006			
Light source		GaAs infrared LED (pulse-modulated) with a peak wavelength of 940 nm			
Receiver		Si photo-diode with a sensing wavelength of 850 nm max.			
Connecting method		EE-1001/1006 Connectors; soldering terminals/cordset			

Note: The response frequency was measured by detecting the disks rotating, as illustrated at the top of the next page.

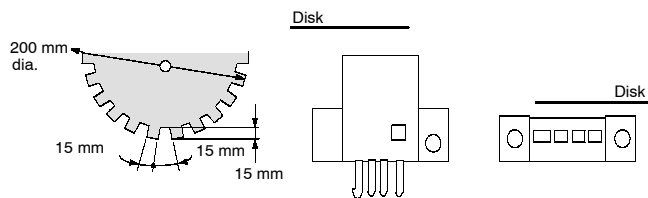

■ CHARACTERISTICS

Ambient illumination	Sensing face: 3,000 lx max. (incandescent light, fluorescent light, and sunlight)
Enclosure ratings	IP50 (except the terminal section)
Ambient operating temperature	-10°C to 55°C (14°F to 131°F)
Vibration resistance	Destruction: 10 to 55 Hz, 1.5-mm double amplitude for 2 hrs each in X, Y, and Z directions
Shock resistance	Destruction: 500 m/s ² (approx. 50G) for 3 times each in X, Y, and Z directions
Cable length	2 m max. (AWG26 min.)

Engineering Data

OPERATING RANGE (TYPICAL)

EE-SPY311/411

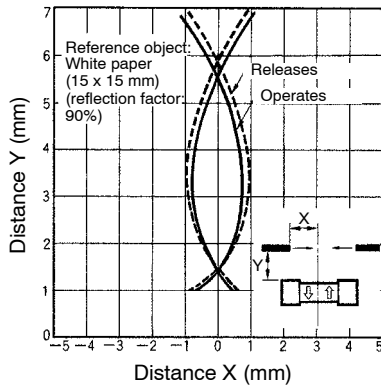

EE-SPY311/411

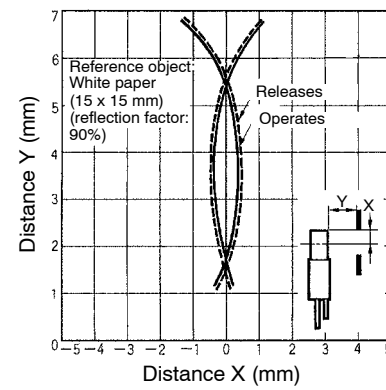

EE-SPY312/412

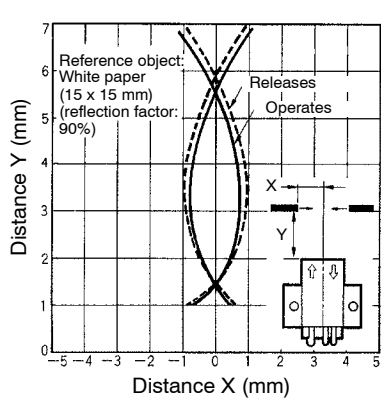

EE-SPY312/412

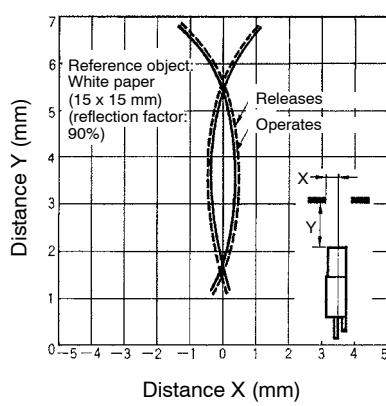

SENSING DISTANCE VS. OBJECT AREA (TYPICAL)

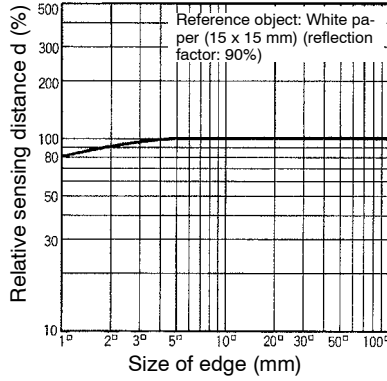

SENSING ANGLE VS. SENSING DISTANCE (TYPICAL)

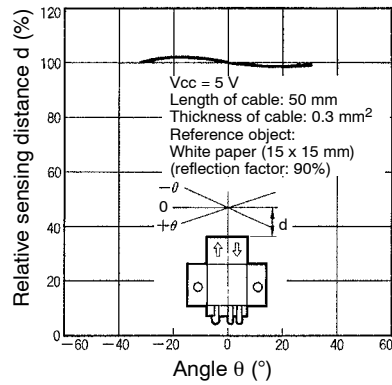

RECEIVER OUTPUT VS. SENSING DISTANCE (TYPICAL)

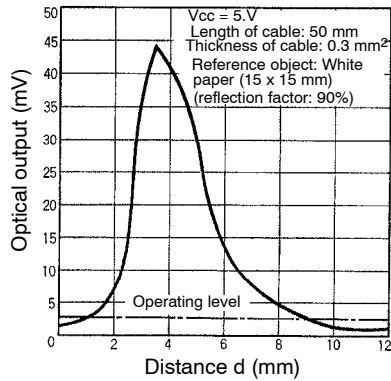

Operation

INTERNAL/EXTERNAL CIRCUIT DIAGRAM

Light-ON/Dark-ON

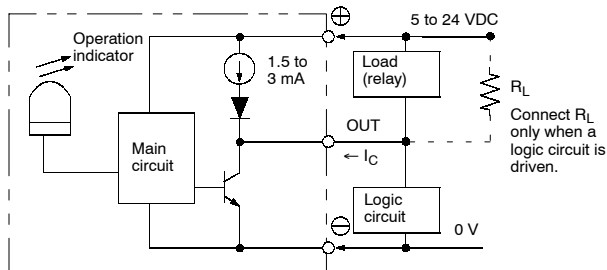

TIMING CHART

Light-ON

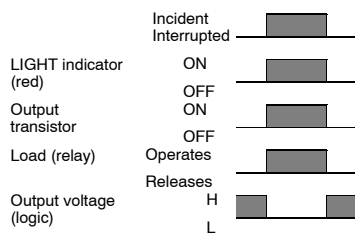

Dark-ON

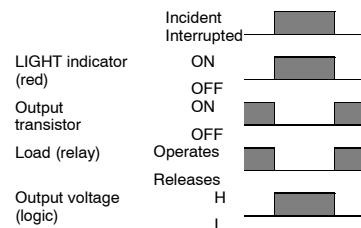

Dimensions

Unit: mm (inch)

EE-SPY311, EE-SPY411

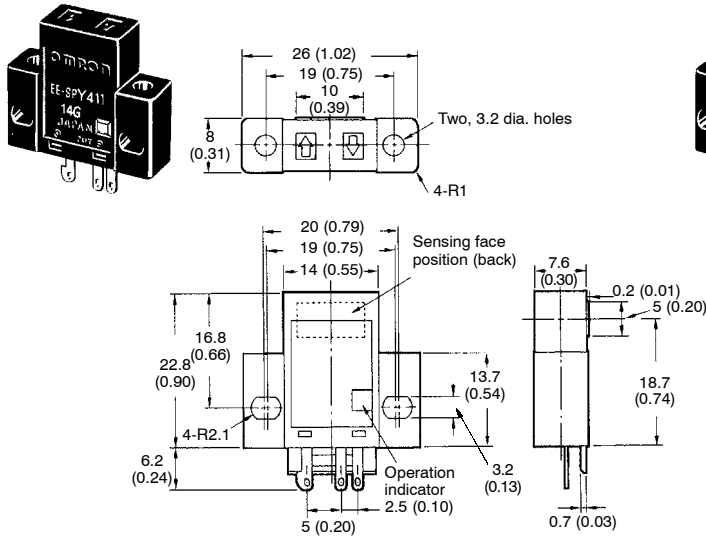

EE-SPY312, EE-SPY412

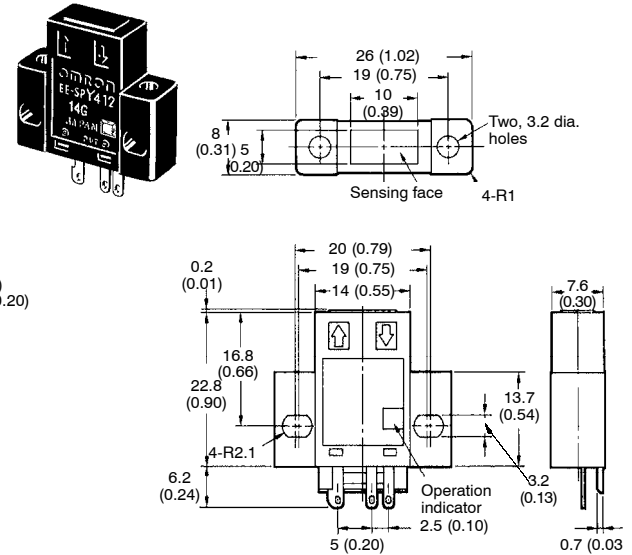

EE-1001 SOLDER CONNECTOR

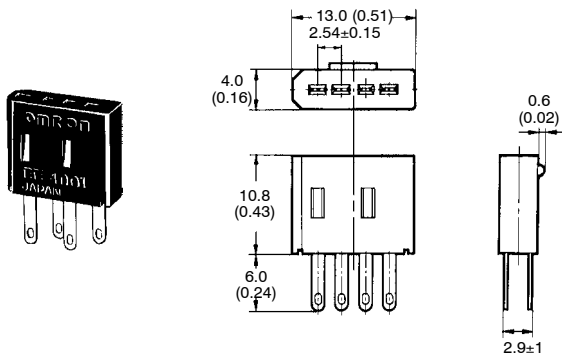

EE-SPY□+ EE-1001, EE-SPY41□+ EE-1001

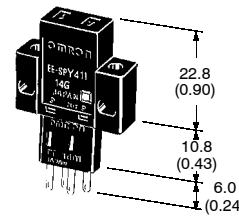

EE-1006 CONNECTOR WITH CABLE

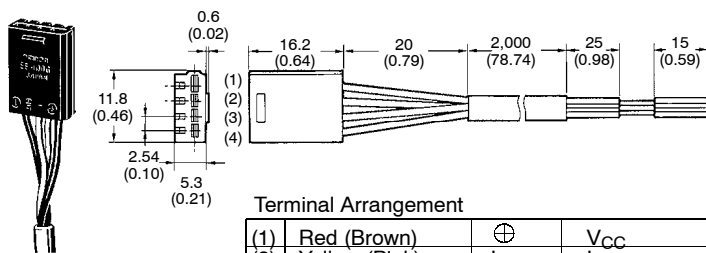

Terminal Arrangement

(1)	Red (Brown)	⊕	V _{CC}
(2)	Yellow (Pink)	⊖	L
(3)	White (Black)	OUT	OUTPUT
(4)	Black (Blue)	⊖	GND (0 V)

IEC colors are shown in parentheses.

EE-SPY31□+ EE-1006, EE-SPY41□+ EE-1006

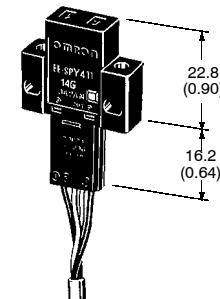

Precautions

Refer to the Technical Information Section for general precautions.

■ WIRING

A cable with a thickness of AWG26 min. and a length of 2 m max. must be connected to the output terminals. To use a cable longer than 2 m, attach a capacitor with a capacitance of approximately 10 μ F to the wires, as shown below. The distance between the terminal and the capacitor must be within 2 m:

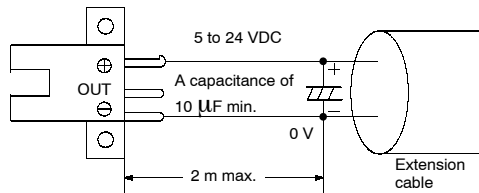

Do not apply excessive force to the terminals (refer to the graphics below). Excess force will damage the terminals.

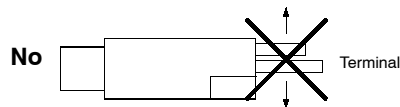

Do not disconnect the EE-1001 or EE-1006 Connector from the photomicrosensor when power is supplied to the photomicrosensor, or sensor damage could result. If the metal mounting base is subjected to inductive electrical noise, the photomicrosensor can be activated accidentally. If noise is a problem, take the following precautions:

1. Connect the negative terminal to the mounting base to ensure that there will be no difference in electric potential between the photomicrosensor and mounting base.

2. Connect the negative terminal to the mounting base with a 0.47- μ F capacitor.
3. Insert a plastic insulating plate with a thickness of approximately 10 mm between the photomicrosensor and mounting base.

Wire as shown by the following illustration to connect a small inductive load (a relay for example) to the photomicrosensor. A diode must be connected parallel to the relay to absorb the reverse voltage.

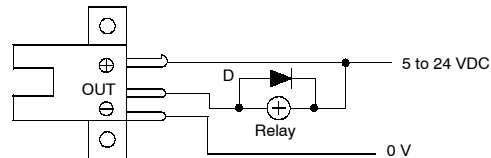

■ POWER SUPPLY

When using a standard switching regulator, ground the FG and G terminal so that the photomicrosensor will be in a stable operating condition.

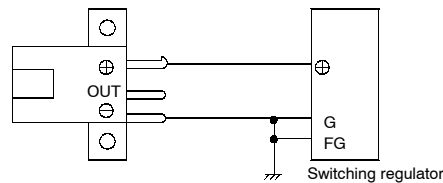

NOTE: DIMENSIONS SHOWN ARE IN MILLIMETERS. To convert millimeters to inches divide by 25.4.

OMRON®

OMRON ELECTRONICS LLC

One East Commerce Drive
Schaumburg, IL 60173

1-800-55-OMRON

OMRON ON-LINE

Global - <http://www.omron.com>
USA - <http://www.omron.com/oei>
Canada - <http://www.omron.com/oci>

OMRON CANADA, INC.

885 Milner Avenue
Toronto, Ontario M1B 5V8

416-286-6465