

The New Standard for Compact, Long-range Photoelectric Sensors Conserves Energy and Natural Resources, One Million Sold Yearly

- Long sensing distance of 15 m for Through-beam Models, 4 m for Retro-reflective Models, and 1 m for Diffuse-reflective Models.
- Unique algorithm minimizes external interference from inverter fluorescent lighting.
- Conserves energy and represents ongoing efforts aimed at eliminating materials containing lead.
- Provides a high degree of protection (IP67), mutual interference prevention, and EN standard compliance.
- Mechanical axis and optical axis offset always less than $\pm 2.5^\circ$ greatly simplifies optical axis alignment.



 Be sure to read *Safety Precautions* on page 15.

Features

Industry's Top-level Sensing Distance with Built-in Amplifier

A separately sold filter is available to prevent mutual interference for Through-beam Models with red lights sources and a sensing distance of 10 m. Reflective Models include functionality to prevent mutual interference.

Long-distance, Through-beam Sensors with a detection distance of 30 m (response time: 2 ms) are also available.

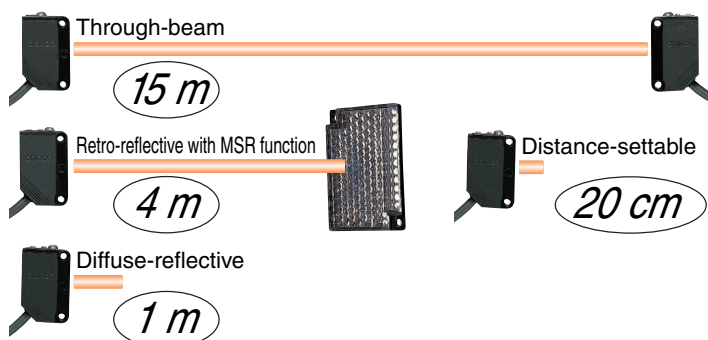

Low-temperature Operation for Applications in Cold-storage Warehouses

A wider ambient operating range from -40 to 55°C (main models with connectors). We also provide Sensor I/O Connectors with PUR Cables for high resistance to cold environments.

Improved Matching of Optical Axis and Mechanical Axis for Through-beam Models and Retro-reflective Models

The offset between the optical axis and the mechanical axis is kept within $\pm 2.5^\circ$, so the optical axis can be accurately set simply by mounting the Sensor according to the mechanical axis.

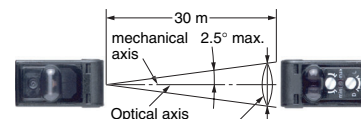

The receiver will always be in the range of light diffusion.

Sensor Protection against Incorrect Wiring

The Sensor includes output reverse polarity protection. (A diode to protect against reverse polarity is added to the output line.)

Through-beam Model receivers and Reflective Models (except the E3Z-LS)

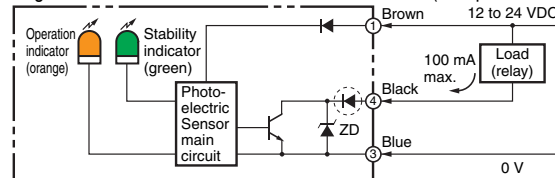

Protection for NPN output models

Complete Compliance with the EU's RoHS Directive



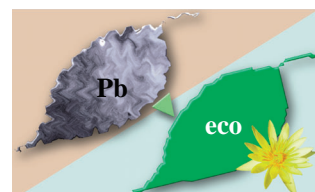







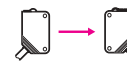

Lead, mercury, cadmium hexachrome, polybrominated biphenyl (PBB), and polybrominated diphenyl ether (PBDE) have all been eliminated. Also, burnable polyethylene packaging has been used.

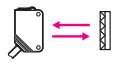

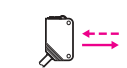
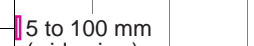
Ordering Information

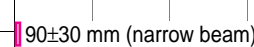
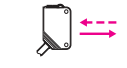
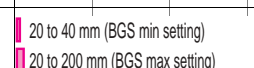
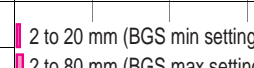
Sensors [Refer to *Dimensions on page 15.*]

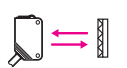
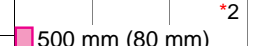
 Red light  Infrared light

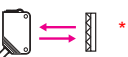
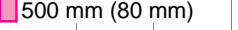
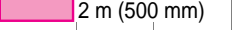
Sensing method	Appearance	Connection method	Sensing distance	Model		
				NPN output	PNP output	
Through-beam (Emitter + Receiver) *3		Pre-wired (2 m)	 15 m	E3Z-T61 2M	E3Z-T81 2M	
		Standard M8 connector		E3Z-T66	E3Z-T86	
		Pre-wired (2 m)	 10 m	E3Z-T61A 2M	E3Z-T81A 2M	
		Standard M8 connector		E3Z-T66A	E3Z-T86A	
		Pre-wired (2 m)	 30m	E3Z-T62 2M	E3Z-T82 2M	
		Standard M8 connector		E3Z-T67	E3Z-T87	
		Pre-wired (2 m)		E3Z-T62-G0 2M	E3Z-T82-G0 2M	
		Standard M8 connector		E3Z-T67-G0	E3Z-T87-G0	
Retro-reflective with MSR function		Pre-wired (2 m)	 4 m *2 (100 mm)	E3Z-R61 2M	E3Z-R81 2M	
		Standard M8 connector		E3Z-R66	E3Z-R86	
Diffuse-reflective		Pre-wired (2 m)	 5 to 100 mm (wide view)	E3Z-D61 2M	E3Z-D81 2M	
		Standard M8 connector		E3Z-D66	E3Z-D86	
		Pre-wired (2 m)	 1 m	E3Z-D62 2M	E3Z-D82 2M	
		Standard M8 connector		E3Z-D67	E3Z-D87	
		Pre-wired (2 m)		 90±30 mm (narrow beam)	E3Z-L61 2M	E3Z-L81 2M
		Standard M8 connector			E3Z-L66	E3Z-L86
Distance-settable Refer to E3Z-LS.		Pre-wired (2 m)	 20 to 40 mm (BGS min setting)  20 to 200 mm (BGS max setting)	E3Z-LS61 2M	E3Z-LS81 2M	
		Standard M8 Connector		 40 min. Incident threshold (FGS min setting)  200 min. Incident threshold (FGS max setting)	E3Z-LS66	E3Z-LS86
		Pre-wired (2 m)		 2 to 20 mm (BGS min setting)  2 to 80 mm (BGS max setting)	E3Z-LS63 2M	E3Z-LS83 2M
		Standard M8 connector			E3Z-LS68	E3Z-LS88
Slit-type Through-beam Refer to E3Z-G.		1 axis	 25 mm	E3Z-G61 2M	E3Z-G81 2M	
		2 axes		E3Z-G62 2M	E3Z-G82 2M	
		1 axis		E3Z-G61-M3J	E3Z-G81-M3J	
		2 axes		E3Z-G62-M3J	E3Z-G82-M3J	
Retro-reflective without MSR function for clear, plastic bottles Refer to E3Z-B.		Pre-wired (2 m)	 500 mm (80 mm) *2	E3Z-B61 2M	E3Z-B81 2M	
		Standard M8 connector		E3Z-B66	E3Z-B86	
		Pre-wired (2 m)	 2 m (500 mm) *2	E3Z-B62 2M	E3Z-B82 2M	
		Standard M8 connector		E3Z-B67	E3Z-B87	

*1. The Reflector is sold separately. Select the Reflector model most suited to the application.

*2. The sensing distance specified is possible when the E39-R1S is used. Values in parentheses indicate the minimum required distance between the Sensor and Reflector.

*3. The model number of the Emitter is expressed by adding an "L" to the set model number in the table.
Example: E3Z-T61J-2M, E3Z-T62-GOJ-2M

The model number of the receiver is expressed by adding a "D" to the set model number in the table.
Example: E3Z-T61-D-2M, E3Z-T62-GO-D-2M

Orders for individual Emitters and Receivers are accepted. (Modifications are required for some models.)

Variety of Connection Specifications

The models with the connection specifications marked with a black circle in the table are available.
The model number indication is a combination of the basic model and the connection specification.

Example: E3Z-T61-M1TJ 0.3M

Basic model number Connection specification

NPN Output

Model			Model number example	E3Z-T61 -M1TJ 0.3M	E3Z-T61 0.5M	E3Z-T61 5M	E3Z-T61 -M1J 0.3M	E3Z-T61 -M3J 0.3M	E3Z-T61 -ECON 0.3M E3Z-T61 -ECON 0.5M	E3Z-T61 -ECON 2M
Sensing method	Sensing distance	Main features	Connection specification	M12 pre-wired Smart-click connector (cable length: 0.3 m)	Pre-wired (cable length: 0.5 m)	Pre-wired (cable length: 5 m)	M12 pre-wired standard connector (cable length: 0.3 m)	M8, 4-pin pre-wired connector (cable length: 0.3 m)	e-CON pre-wired connector (cable length: 0.3 m/0.5 m)	e-CON pre-wired connector (cable length: 2 m)
			Basic model number	-M1TJ 0.3M	0.5M	5M	-M1J 0.3M	-M3J 0.3M	-ECON 0.3M -ECON 0.5M	-ECON 2M
Through-beam	15 m	Infrared light	E3Z-T61	●	●	●	●	●	●	●
	10 m	Red light	E3Z-T61A	---	●	●	●	---	●	●
	30 m	2-ms response	E3Z-T62	---	●	---	---	---	---	---
Retro-reflective	4 m	MSR function	E3Z-R61	●	●	●	●	●	●	●
Diffuse-reflective (narrow-beam reflective)	100 mm	Wide view	E3Z-D61	---	●	●	●	●	●	●
	1 m	Long distance	E3Z-D62	●	●	●	●	●	●	●
	90 mm	Narrow beam	E3Z-L61	●	●	●	●	---	●	●
Distance-settable	200 mm	FGS function	E3Z-LS61	---	●	●	●	●	●	●
	80 mm	Small spot	E3Z-LS63	---	●	---	---	---	---	---
Slit-type	25 mm	1 optical axis	E3Z-G61	●	●	●	●	●	●	●
		2 optical axes	E3Z-G62	---	●	●	●	●	●	●
Retro-reflective for clear, plastic bottles	500 mm	No MSR function	E3Z-B61	---	●	●	---	---	●	●
	2 m		E3Z-B62	---	●	●	●	---	●	●







Clamp-type e-CON pre-wired connectors are also available for models shaded in .
Add "-ECON-C 2M" after the basic model number to specify the connectors.

PNP Output

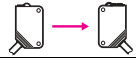
Model			Model number example	E3Z-T81 -M1TJ 0.3M	E3Z-T81 0.5M	E3Z-T81 5M	E3Z-T81 -M1J 0.3M	E3Z-T81 -M3J 0.3M
Sensing method	Sensing distance	Main features	Connection specification	M12 pre-wired Smartclick connector (cable length: 0.3 m)	Pre-wired (cable length: 0.5 m)	Pre-wired (cable length: 5 m)	M12 pre-wired standard connector (cable length: 0.3 m)	M8, 4-pin pre-wired connector (cable length: 0.3 m)
			Basic model number	-M1TJ 0.3M	0.5M	5M	-M1J 0.3M	-M3J 0.3M
Through-beam	15 m	Infrared light	E3Z-T81	●	●	●	●	●
	10 m	Red light	E3Z-T81A	---	---	---	●	---
	30 m	2-ms response	E3Z-T82	---	●	---	---	---
Retro-reflective	4 m	MSR function	E3Z-R81	●	●	●	●	●
Diffuse-reflective (narrow-beam reflective)	100 mm	Wide view	E3Z-D81	●	●	●	●	●
	1 m	Long distance	E3Z-D82	●	●	●	●	●
	90 mm	Narrow beam	E3Z-L81	●	●	●	●	---
Distance-settable	200 mm	FGS function	E3Z-LS81	---	●	●	●	●
	80 mm	Small spot	E3Z-LS83	---	●	---	---	---
Slit-type	25 mm	1 optical axis	E3Z-G81	●	●	---	●	●
		2 optical axes	E3Z-G82	---	●	---	●	●
Retro-reflective for clear, plastic bottles	500 mm	No MSR function	E3Z-B81	---	●	---	●	---
	2 m		E3Z-B82	---	●	●	●	---

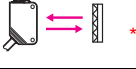
Oil-resistive Sensors [Refer to Dimensions on page 15.]

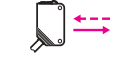
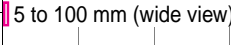
 Red light  Infrared light

Sensing method	Appearance	Connection method	Sensing distance	Model		
				NPN output	PNP output	
Through-beam (Emitter + Receiver) *3		Pre-wired (2 m)	 15 m	E3Z-T61K 2M	E3Z-T81K 2M	
		Pre-wired M8 connector		E3Z-T61K-M3J 0.3M	E3Z-T81K-M3J 0.3M	
Retro-reflective with MSR function		Pre-wired (2 m)	 3 m (150 mm) *2	E3Z-R61K 2M	E3Z-R81K 2M	
		Pre-wired M8 connector		E3Z-R61K-M3J 0.3M	E3Z-R81K-M3J 0.3M	
Diffuse-reflective		Pre-wired (2 m)	 5 to 100 mm (wide view)	E3Z-D61K 2M	E3Z-D81K 2M	
		Pre-wired M8 connector		E3Z-D61K-M3J 0.3M	E3Z-D81K-M3J 0.3M	
		Pre-wired (2 m)		 1 m	E3Z-D62K 2M	E3Z-D82K 2M
		Pre-wired M8 connector			E3Z-D62K-M3J 0.3M	E3Z-D82K-M3J 0.3M

*1. The Reflector is sold separately. Select the Reflector model most suited to the application.

*2. The sensing distance specified is possible when the E39-R1S is used. Values in parentheses indicate the minimum required distance between the Sensor and Reflector.

*3. The model number of the Emitter is expressed by adding an "L" to the set model number in the table.

Example: E3Z-T61K-L 2M, E3Z-T61K-L-M3J 0.3M

The model number of the receiver is expressed by adding a "D" to the set model number in the table.

Example: E3Z-T61K-D 2M, E3Z-T61K-D-M3J 0.3M

Orders for individual Emitters and Receivers are accepted. (Modifications are required for some models.)

Accessories (Order Separately)

Slit [Refer to Dimensions on page 17.]

Slit width	Sensing distance		Minimum detectable object (typical)	Model	Contents
	E3Z-T□□	E3Z-T□□A			
0.5-mm dia.	50 mm	35 mm	0.2-mm dia.	E39-S65A	One set (contains Slits for both the Emitter and Receiver)
1-mm dia.	200 mm	150 mm	0.4-mm dia.	E39-S65B	
2-mm dia.	800 mm	550 mm	0.7-mm dia.	E39-S65C	
0.5 × 10 mm	1 m	700 mm	0.2-mm dia.	E39-S65D	
1 × 10 mm	2.2 m	1.5 m	0.5-mm dia.	E39-S65E	
2 × 10 mm	5 m	3.5 m	0.8-mm dia.	E39-S65F	

Reflectors [Refer to Dimensions on E39-LIF39-L/E39-S/E39-R]

Name	E3Z-R Sensing distance (typical)*	Model	Quantity	Remarks
Reflector	3 m (100 mm) (rated value)	E39-R1	1	<ul style="list-style-type: none"> • Retro-reflective models are not provided with Reflectors. • The MSR function is enabled.
	4 m (100 mm) (rated value)	E39-R1S	1	
	5 m (100 mm)	E39-R2	1	
	2.5 m (100 mm)	E39-R9	1	
	3.5 m (100 mm)	E39-R10	1	
Fog Preventive Coating	3 m (100 mm)	E39-R1K	1	
Small Reflector	1.5 m (50 mm)	E39-R3	1	
Tape Reflector	700 mm (150 mm)	E39-RS1	1	
	1.1 m (150 mm)	E39-RS2	1	
	1.4 m (150 mm)	E39-RS3	1	

Note: The actual sensing distance may be reduced to approximately 70% of the typical sensing distance when using a Reflector other than E39-R1 or E39-R1S.







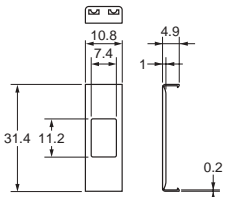

*1. Refer to Reflectors on E39-L/F39-L/E39-S/E39-R for details.

*2. Values in parentheses indicates the minimum required distance between the Sensor and Reflector.

Mutual Interference Protection Filter

Sensing distance	Appearance/Dimensions	Model	Quantity	Remarks
3 m		E39-E11	Two sets each for the Emitter and Receiver (total of four pieces)	Can be used with the E3Z-T□□A Through-beam models. The arrow indicates the direction of polarized light. Mutual interference can be prevented by altering the direction of polarized light from or to adjacent Emitters and Receivers.

Mounting Brackets [Refer to Dimensions on E39-L/F39-L/E39-S/E39-R]







Appearance	Model (material)	Quantity	Remarks	Appearance	Model (material)	Quantity	Remarks
	E39-L153 (SUS304)	1	Mounting Brackets		E39-L98 (SUS304)	1	Metal Protective Cover Bracket *
	E39-L104 (SUS304)	1			E39-L150 (SUS304)	1 set	(Sensor adjuster)
	E39-L43 (SUS304)	1	Horizontal Mounting Brackets *		E39-L151 (SUS304)	1 set	Easily mounted to the aluminum frame rails of conveyors and easily adjusted.
	E39-L142 (SUS304)	1	Horizontal Protective Cover Bracket *				For left to right adjustment
	E39-L44 (SUS304)	1	Rear Mounting Bracket		E39-L144 (SUS304)	1	Compact Protective Cover Bracket (For E3Z only) *

Note: When using Through-beam models, order one bracket for the Receiver and one for the Emitter.

*1. Refer to *Mounting Brackets* on E39-L/F39-L/E39-S/E39-R for details.

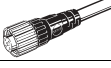
*2. Cannot be used for Standard Connector models.

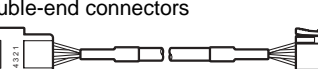
Sensor I/O Connectors [Refer to Dimensions on XS2 and XS3]

Size	Cable	Appearance	Cable type	Model
M8 *1	Standard	Straight 	2 m	XS3F-M421-402-A
			5 m	XS3F-M421-405-A
		L-shaped 	2 m	XS3F-M422-402-A
			5 m	XS3F-M422-405-A
M12 *1 (For -M1J models)	Standard	Straight 	2 m	XS2F-D421-DC0-A
			5 m	XS2F-D421-GC0-A
		L-shaped 	2 m	XS2F-D422-DC0-A
			5 m	XS2F-D422-GC0-A
e-CON	Standard	Single-end connector 	2 m	E39-ECON2M
			5 m	E39-ECON5M
		Double-end connectors 	0.5 to 1 m	E39-ECONW□M
			1.1 to 1.5 m 1.6 to 2 m	□ indicates cable length (in units of m). Specify with 0.1-increments.
M8	PUR (Polyurethane) cable *2	Straight 	2 m	XS3F-M421-402-L
			5 m	XS3F-M421-405-L
		L-shaped 	2 m	XS3F-M422-402-L
			5 m	XS3F-M422-405-L

Note: 1. Refer to *Introduction to Sensor I/O Connectors* for details.

2. The Sensor can be used in low-temperature environments (-25°C to -40°C). Do not use the Sensor in locations that are subject to oil.

Ratings and Specifications

Item	Sensing method		Through-beam			Retro-reflective with MSR function	Diffuse-reflective		(Narrow-beam Models)
	Model	Pre-wired	E3Z-T61	E3Z-T62	E3Z-T61A	E3Z-R61	E3Z-D61	E3Z-D62	E3Z-L61
		Connector (M8)	E3Z-T66	E3Z-T67	E3Z-T66A	E3Z-R66	E3Z-D66	E3Z-D67	E3Z-L66
	PNP output	Pre-wired	E3Z-T81	E3Z-T82	E3Z-T81A	E3Z-R81	E3Z-D81	E3Z-D82	E3Z-L81
	Connector (M8)	E3Z-T86	E3Z-T87	E3Z-T86A	E3Z-R86	E3Z-D86	E3Z-D87	E3Z-L86	
Sensing distance			15 m	30 m	10 m	4 m (100 mm) *1 (when using E39-R1S) 3 m (100 mm) *1 (when using E39-R1)	White paper (100 × 100 mm): 100 mm	White paper (300 × 300 mm): 1 m	90 + 30 mm (white paper, 100 x 100 mm)
Spot diameter (typical)			---						(2.5 dia. and sensing distance of 90 mm)
Standard sensing object			Opaque: 12-mm dia. min.			Opaque: 75-mm dia. min.	---		
Minimum detectable object (typical)			---						0.1 mm (copper wire)
Differential travel			---				20% max. of setting distance		Refer to <i>Engineering data</i> on page 9.
Directional angle			Both emitter and receiver: 3 to 15°			2 to 10°		---	
Light source (wavelength)			Infrared LED (870 nm)		Red LED (660 nm)	Red LED (660 nm)	Infrared LED (860 nm)		Red LED (650 nm)
Power supply voltage			12 to 24 VDC±10%, ripple (p-p): 10% max.						
Current consumption			35 mA max. (Emitter: 15 mA max., Receiver: 20 mA max.)			30 mA max.			
Control output			Load power supply voltage: 26.4 VDC max., Load current: 100 mA max. Residual voltage: Load current of less than 10 mA: 1 V max. Load current of 10 to 100 mA: 2 V max. Open collector output (NPN/PNP depending on model) Light-ON/Dark-ON selectable						
Protection circuits			Reversed power supply polarity protection, Output short-circuit protection, and Reversed output polarity protection			Reversed power supply polarity protection, Output short-circuit protection, Mutual interference prevention, and Reversed output polarity protection			
Response time			Operate or reset: 1 ms max.	Operate or reset: 2 ms max.	Operate or reset: 1 ms max.				
Sensitivity adjustment			One-turn adjuster						
Ambient illumination (Receiver side)			Incandescent lamp: 3,000 lx max. Sunlight: 10,000 lx max.						
Ambient temperature range			Operating: -25 to 55°C, Some connector models: -40°C to 55°C *2 (with no icing or condensation)						
Ambient humidity range			Operating: 35% to 85%, Storage: 35% to 95% (with no condensation)						
Insulation resistance			20 MΩ min. at 500 VDC						
Dielectric strength			1,000 VAC, 50/60 Hz for 1 min						
Vibration resistance			Destruction: 10 to 55 Hz, 1.5-mm double amplitude for 2 hours each in X, Y, and Z directions						
Shock resistance			Destruction: 500 m/s ² 3 times each in X, Y, and Z directions						
Degree of protection			IEC, IP67						
Connection method			Pre-wired cable (standard length: 2 m and 0.5 m), Connector (M8)						
Indicator			Operation indicator (orange) Stability indicator (green) Emitter has power indicator (orange) only.						
Weight (packed state)	Pre-wired cable (2 m)		Approx. 120 g			Approx. 65 g			
	Connector		Approx. 30 g			Approx. 20 g			
Material	Case		PBT (polybutylene terephthalate)						
	Lens		Modified polyarylate			Methacrylic resin	Modified polyarylate		
Accessories			Instruction manual (Neither Reflectors nor Mounting Brackets are provided with any of the above models.)						

*1. Values in parentheses indicate the minimum required distance between the Sensor and Reflector.

*2. The ambient temperature range during operation for connector models depends on the model. For the E3Z-T66/T86/R66/R86, the range is -40°C to 55°C. For the E3Z-D66/D86/D67/D87, the range is -30°C to 55°C. For other connector models, the range is -25°C to -55°C.

The sensing distance for Retro-reflective Models (E3Z-R66/R86) between -40°C to -25°C, however, will be as follows (not the values in the table):

With E39-R1S: 3 m (100 mm), With E39-R1: 2 m (100 mm).

Also, use the XS3F-M42□-4□□-L Sensor I/O Connector (PUR cable) for applications between -25°C to -40°C. (Refer to page 6.)

The E3Z-T□2-G0 is equipped with an emission stop function. Ratings and specifications of this function are given in the following table.

Item	Sensing method Output and Modes	Through-beam models, NPN output: E3Z-T62/T67-G0, PNP output: E3Z-T82/T87-G0
Emission stop function	Input	<NPN models> Emission OFF: Short-circuit to 0 V or 1.5 V max. (Outflow current 1 mA max.), Emission ON: Disconnected (Leakage current 0.1 mA max.) <PNP models> Emission OFF: Short-circuit to +DC (Power supply plus side) or +DC-1.5 V max. (Inlet current 3 mA max.), Emission ON: Disconnected (Leakage current 0.1 mA max.)
	Response time	Operate or reset: 0.5 ms max.

Oil-resistant

Item	Model	Sensing method		Through-beam	Retro-reflective	Diffuse-reflective	
		NPN output	Pre-wired Models	E3Z-T61K	E3Z-R61K	E3Z-D61K	E3Z-D62K
			M8 Pre-wired connector	E3Z-T61K-M3J	E3Z-R61K-M3J	E3Z-D61K-M3J	E3Z-D62K-M3J
			Pre-wired Models	E3Z-T81K	E3Z-R81K	E3Z-D81K	E3Z-D82K
		PNP output	M8 Pre-wired connector	E3Z-T81K-M3J	E3Z-R81K-M3J	E3Z-D81K-M3J	E3Z-D82K-M3J
Sensing distance				15 m	3 m (150 mm) * (when using E39-R1S) 2 m (100 mm) * (when using E39-R1)	100 mm (white paper: 100 × 100 mm)	1 m (white paper: 300 × 300 mm)
Spot diameter		---					
Standard sensing object				Opaque: 12-mm dia. min.	Opaque: 75-mm dia. min.	---	
Minimum detectable object		---					
Differential travel		---				20% max. of setting distance	
Directional angle				Both emitter and receiver: 3 to 15°	2 to 10°	---	
Light source (wavelength)				Infrared LED (870 nm)	Red LED (660 nm)	Infrared LED (860 nm)	
Power supply voltage		12 to 24 VDC ±10%, ripple (p-p): 10% max.					
Current consumption				35 mA max. (Emitter: 15 mA max., Receiver: 20 mA max.)	30 mA max.		
Control output		Load power supply voltage: 26.4 VDC max., Load current: 100 mA max. Residual voltage: Load current of less than 10 mA: 1 V max. Load current of 10 to 100 mA: 2 V max. Open collector output (NPN/PNP depending on model) Light-ON/Dark-ON selectable					
Protection circuits				Reversed power supply polarity protection, Output short-circuit protection, and Reversed output polarity protection	Reversed power supply polarity protection, Output short-circuit protection, Mutual interference prevention, and Reversed output polarity protection		
Response time		Operate or reset: 1 ms max.					
Sensitivity adjustment		One-turn adjuster					
Ambient illumination (Receiver side)		Incandescent lamp: 3,000 lx max. Sunlight: 10,000 lx max.					
Ambient temperature range		Operating: -25 to 55°C, Storage: -40 to 70°C (with no icing or condensation)					
Ambient humidity range		Operating: 35% to 85%, Storage: 35% to 95% (with no condensation)					
Insulation resistance		20 MΩ min. at 500 VDC					
Dielectric strength		1,000 VAC, 50/60 Hz for 1 min					
Vibration resistance		Destruction: 10 to 55 Hz, 1.5-mm double amplitude for 2 hours each in X, Y, and Z directions					
Shock resistance		Destruction: 500 m/s ² 3 times each in X, Y, and Z directions					
Degree of protection		IP67 (IEC), Oil resistant models: IP67 (IEC) (in-house standards: oilproof), excluding cables and connectors					
Connection method		Pre-wired cable (standard length: 2 m), M8 Pre-wired Connector					
Indicator		Operation indicator (orange) Stability indicator (green) Emitter has power indicator (orange) only.					
Weight (packed state)	Pre-wired cable (2 m)			Approx. 120 g	Approx. 65 g		
	Connector (M8, 4 pins)			Approx. 50 g	Approx. 30 g		
Material	Case	PBT (polybutylene terephthalate)					
	Lens			Modified polyarylate	Methacrylic resin	Modified polyarylate	
Accessories		Instruction manual (Neither Reflectors nor Mounting Brackets are provided with any of the above models.)					

* Values in parentheses indicate the minimum required distance between the Sensor and Reflector.

Engineering Data (Typical)

Parallel Operating Range

Through-beam Models

E3Z-T□1(T□6)

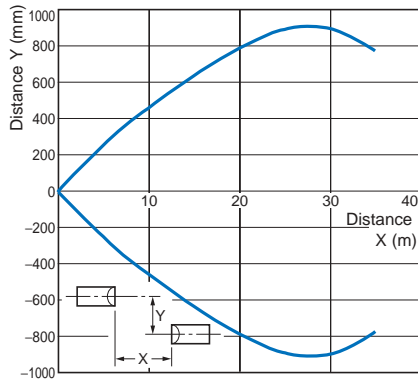

Through-beam Models

E3Z-T□A

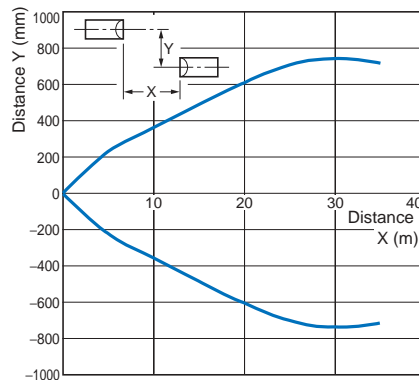

Through-beam Models

E3Z-T□2(T□7)

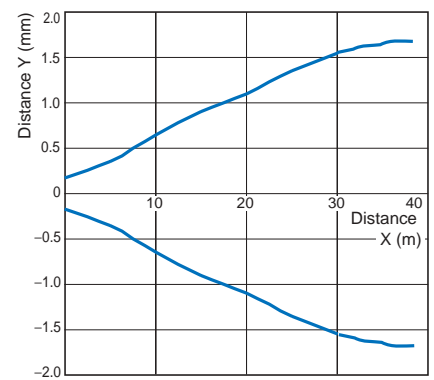

Through-beam Models

E3Z-T□1(T□6) and Slit

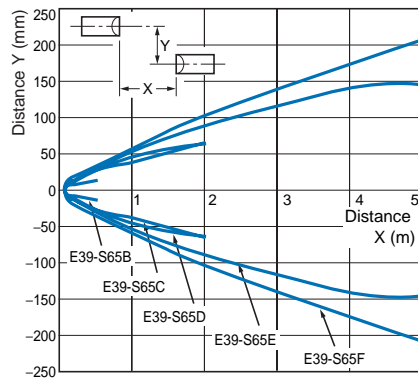

Through-beam Models

E3Z-T□A and Slit

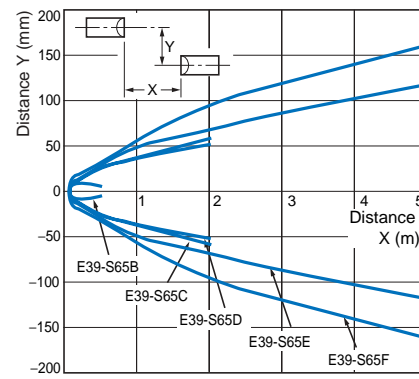

Retro-reflective Models

E3Z-R□1(R□6) and Reflector

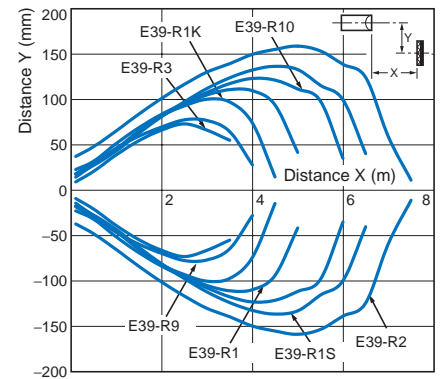

Operating Range

Diffuse-reflective Models

E3Z-D□1(D□6)

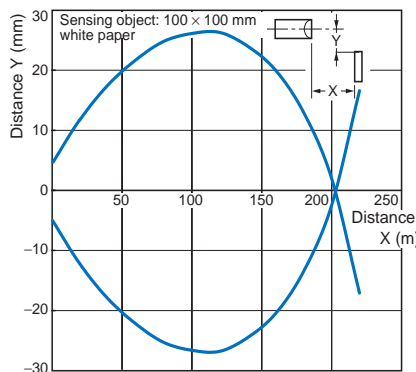

Diffuse-reflective Models

E3Z-D□2(D□7)

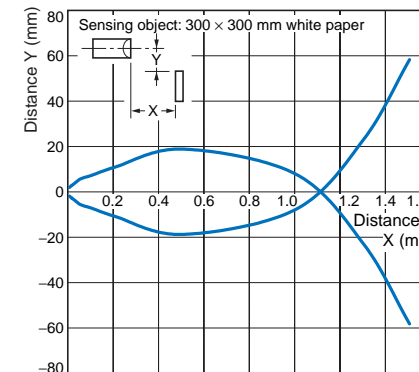

Narrow-beam Reflective Models

E3Z-L□1(L□6)

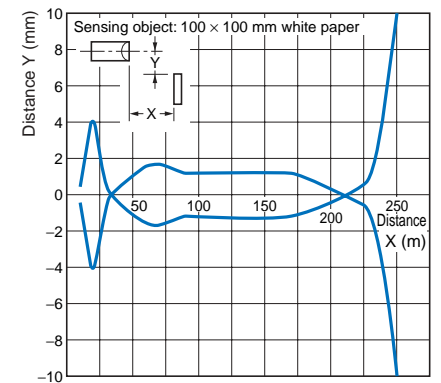

Excess Gain vs. Set Distance

Through-beam Models

E3Z-T□1(T□6)/-T□A/-T□2(T□7)

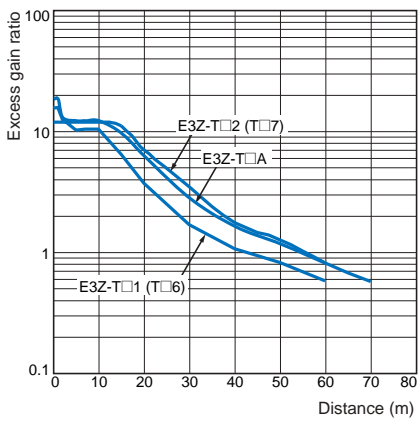

Retro-reflective Models

E3Z-R□1(R□6) and Reflector

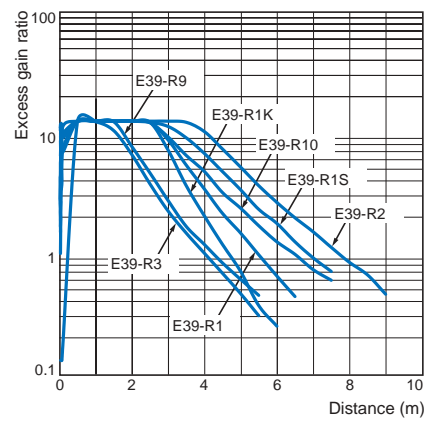

Diffuse-reflective Models

E3Z-D□1(D□6)

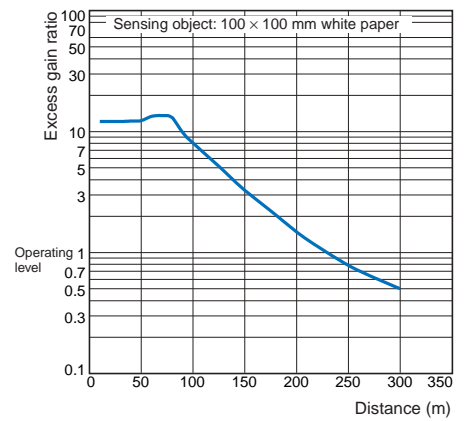

Diffuse-reflective Models

E3Z-D□2(D□7)

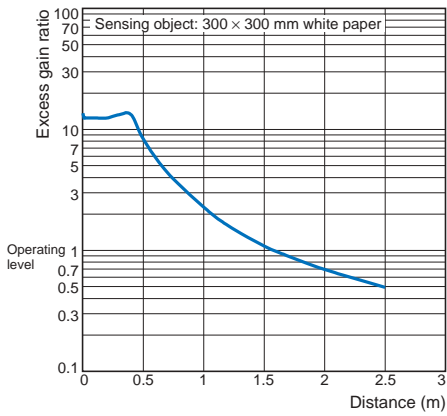

Narrow-beam Reflective Models

E3Z-L□1(L□6)

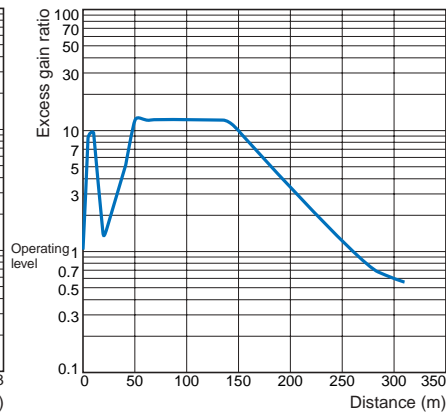

Sensing Object Size vs. Sensing Distance

Diffuse-reflective Models

E3Z-D□1(D□6)

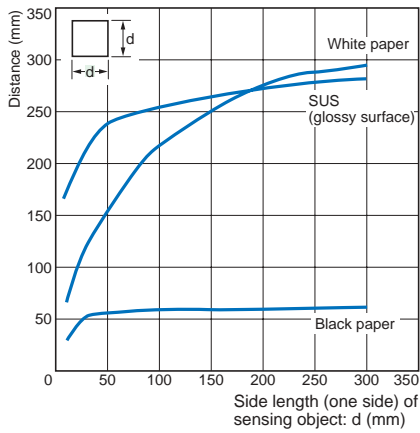

Diffuse-reflective Models

E3Z-D□2(D□7)

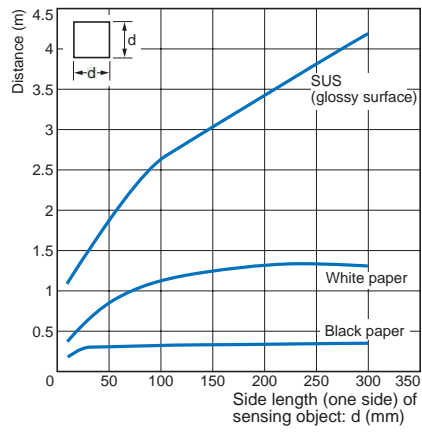

Narrow-beam Reflective Models

E3Z-L□1(L□6)

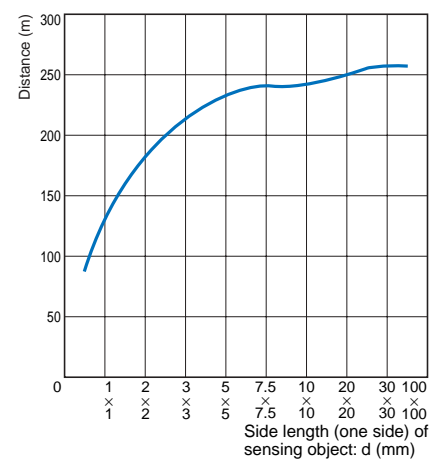

Spot Diameter vs. Sensing Distance

Narrow-beam Reflective Models

E3Z-L□1(L□6)

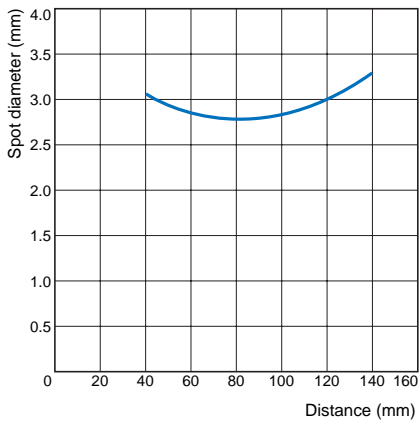

Differential Travel vs. Sensing Distance

Narrow-beam Reflective Models

E3Z-L□1(L□6)

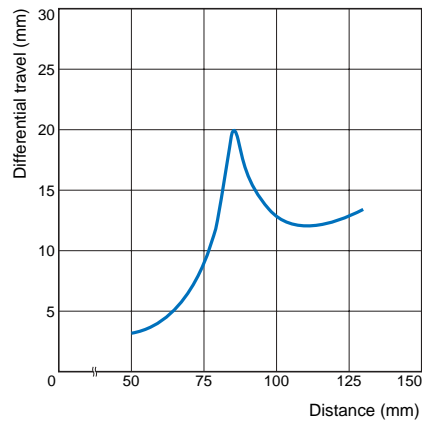

I/O Circuit Diagrams

NPN Output

Model	Operation mode	Timing charts	Operation selector	Output circuit
E3Z-T61(K) E3Z-T66 E3Z-T62 E3Z-T67 E3Z-T61A E3Z-T66A E3Z-R61(K) E3Z-R66 E3Z-D61(K) E3Z-D66 E3Z-D62(K) E3Z-D67 E3Z-L61 E3Z-L66	Light-ON	Incident light No incident light Operation indicator ON (orange) OFF Output transistor OFF Load Operate (e.g., relay) Reset (Between brown (1) and black (4) leads)	L side (LIGHT ON)	Through-beam Receivers, Retro-reflective Models, Diffuse-reflective Models. Connector Pin Arrangement e-CON Connector Pin Arrangement Pin 2 is not used.
	Dark-ON	Incident light No incident light Operation indicator ON (orange) OFF Output transistor ON Load Operate (e.g., relay) Reset (Between brown (1) and black (4) leads)	D side (DARK ON)	Through-beam Emitter Connector Pin Arrangement e-CON Connector Pin Arrangement Pins 2 and 4 are not used.
E3Z-T62-G0 E3Z-T67-G0	---	Emission ON stop input OFF (Between blue (3) and pink (2) leads) LED for emission ON OFF Indicator ON (orange) OFF	---	Through-beam Emitter Connector Pin Arrangement Pin 4 is not used.

PNP Output

Model	Operation mode	Timing charts	Operation selector	Output circuit
E3Z-T81(K) E3Z-T86 E3Z-T82 E3Z-T87 E3Z-T81A E3Z-T86A E3Z-R81(K) E3Z-R86 E3Z-D81(K) E3Z-D86 E3Z-D82(K) E3Z-D87 E3Z-L81 E3Z-L86	Light-ON	Incident light No incident light Operation indicator ON (orange) OFF Output transistor ON Load Operate (e.g., relay) Reset (Between blue (3) and black (4) leads)	L side (LIGHT ON)	Through-beam Receivers, Retro-reflective Models, Diffuse-reflective Models Connector Pin Arrangement Pin 2 is not used.
	Dark-ON	Incident light No incident light Operation indicator ON (orange) OFF Output transistor OFF Load Operate (e.g., relay) Reset (Between blue (3) and black (4) leads)	D side (DARK ON)	Through-beam Emitter Connector Pin Arrangement Pins 2 and 4 are not used.
E3Z-T82-G0 E3Z-T87-G0	---	Emission ON stop input OFF (Between brown (1) and pink (2) leads) LED for emission ON OFF Indicator ON (orange) OFF	---	Through-beam Emitter Connector Pin Arrangement Pin 4 is not used.

Plugs (Sensor I/O Connectors)

Wire color
Brown
White
Blue
Black

XS3F-M421-402-A
XS3F-M421-405-A
XS3F-M422-402-A
XS3F-M422-405-A

E39-ECON□M

E39-ECONW□M

Classification	Wire color	Connector pin No.	Application
DC	Brown	1	Power supply (+V)
	White	2	(Emission stop input)
	Blue	3	Power supply (0 V)
	Black	4	Output

Note: Pin 2 is not used.

Nomenclature

Through-beam Models

E3Z-T□□ (Emitter)

E3Z-T□□A (Receiver)

Retro-reflective Models

E3Z-R□□

Diffuse-reflective Models

E3Z-D□□

Narrow-beam Reflective Models

E3Z-L□

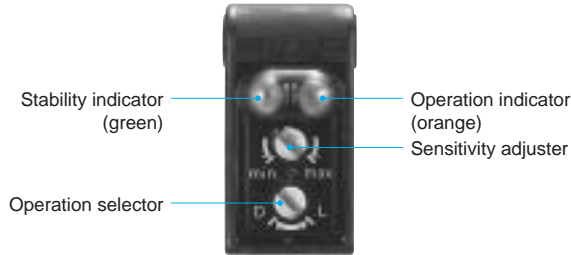

Safety Precautions

Refer to *Warranty and Limitations of Liability*.

WARNING

This product is not designed or rated for ensuring safety of persons either directly or indirectly. Do not use it for such purposes.



Precautions for Correct Use

Do not use the product in atmospheres or environments that exceed product ratings.

● Wiring

M8 Metal Connector

- Be sure to connect or disconnect the metal connector after turning OFF the Sensor.
- Hold the connector cover to connect or disconnect the metal connector.
- Secure the connector cover by hand. Do not use any pliers, otherwise the connector may be damaged.
- The proper tightening torque range is between 0.3 and 0.4 N·m. Be sure to tighten the connector securely, otherwise the specified degree of protection may not be maintained or the connector may be disconnected due to vibration.

● Mounting

Sensor Mounting

Use M3 screws to mount the sensor and tighten each screw to a maximum torque of 0.53 N·m.

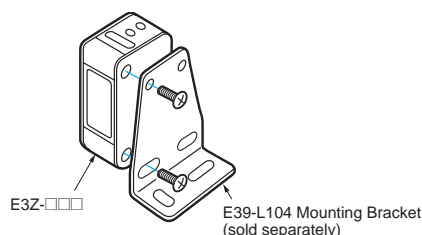

● Oil-resistant Models

Oil Resistance

- Although the E3Z-□□□□K Sensors have oil-resistant specifications, performance may be affected by certain types of oil. Refer to the following table.
- E3Z-□□□□K Sensors are tested for resistance to the oils given in the following table. Refer to the information in the table when deciding which type of oil to use.

Test oil classification	Product name	Kinematic viscosity (mm ² /s) at 40°C	pH
Lubricant	Velocity No.3	2.02	---
Water insoluble machining oil	Yushiron Oil No.2 ac	Less than 10	
Water soluble machining oil	Yushiroken EC50T-3	---	7 to 9.5
	Yushiron Lubic HWC68		7 to 9.9
	Gryton 1700D		7 to 9.2
	Yushironken S50N		7 to 9.8

Note: 1. The E3Z maintained a minimum insulation resistance of 100 MΩ after it was dipped in all the above oils for 240 hours.

2. When using the Sensors in environments subject to oils other than those listed above, use the figures for kinematic viscosity and pH from the table as general guidelines. Additives and other substances contained in oils may affect the E3Z. Be sure to consider this before use.

Dimensions

Tolerance class IT16 applies to dimensions in this data sheet unless otherwise specified.

Sensors

**Through-beam
Pre-wired Models**
E3Z-T61(K)
E3Z-T81(K)
E3Z-T61A
E3Z-T81A
E3Z-T62(-G0)
E3Z-T82(-G0)

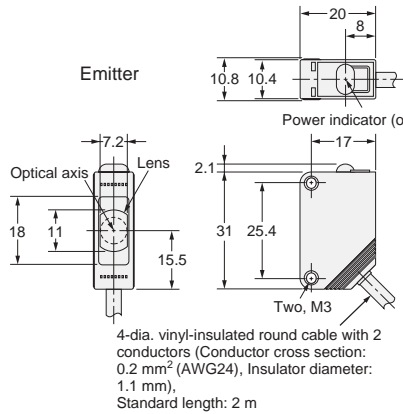

4-dia. vinyl-insulated round cable with 2 conductors (Conductor cross section: 0.2 mm² (AWG24), Insulator diameter: 1.1 mm), Standard length: 2 m

(Excluding -G0)

Terminal No.	Specifications
1	+V
2	---
3	0V
4	---

Pins 2 and 4 are not used.

(-G0)

Terminal No.	Specifications
1	+V
2	Input
3	0V
4	---

Pin 4 is not used.

Press-fit e-CON Pre-wired Connector

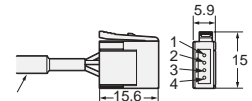

*4-dia. vinyl-insulated round cable with 2 or 3 conductors, Standard lengths: 0.3 m, 0.5 m, and 2 m

Clamp-type e-CON Pre-wired Connector (E3Z-T61-ECON-C)

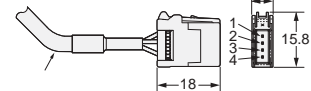

*4-dia. vinyl-insulated round cable with 2 or 3 conductors, Standard length: 2 m

M12 Pre-wired Connector (E3Z-T□□-M1J)

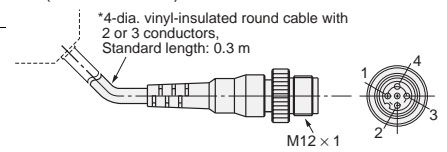

*4-dia. vinyl-insulated round cable with 2 or 3 conductors, Standard length: 0.3 m

M8 Pre-wired Connector (E3Z-T□□K-M3J)

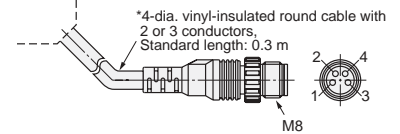

*4-dia. vinyl-insulated round cable with 2 or 3 conductors, Standard length: 0.3 m

* The Emitter cable has two conductors and the Receiver cable has three conductors.

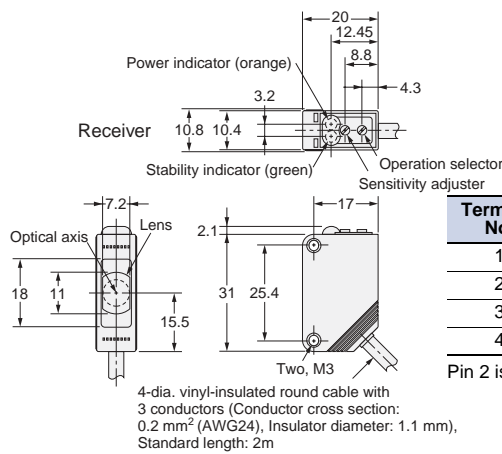

4-dia. vinyl-insulated round cable with 3 conductors (Conductor cross section: 0.2 mm² (AWG24), Insulator diameter: 1.1 mm), Standard length: 2 m

Terminal No.	Specifications
1	+V
2	---
3	0V
4	Output

Pin 2 is not used.

**Through-beam
Connector Models**
E3Z-T66
E3Z-T86
E3Z-T66A
E3Z-T86A
E3Z-T67(-G0)
E3Z-T87(-G0)

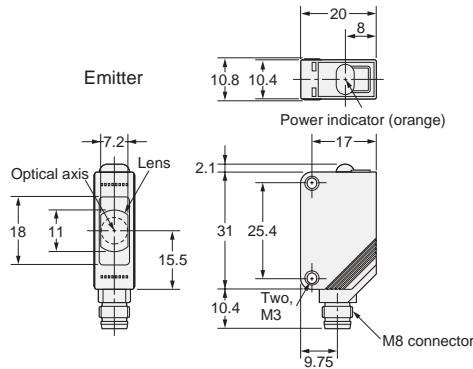

(Excluding -G0)

Terminal No.	Specifications
1	+V
2	---
3	0V
4	---

Pins 2 and 4 are not used.

(-G0)

Terminal No.	Specifications
1	+V
2	Input
3	0V
4	---

Pin 4 is not used.

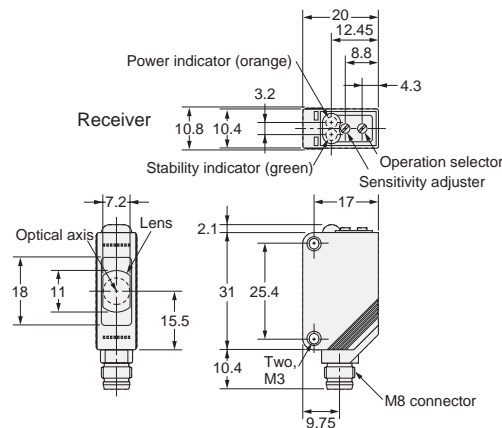

Terminal No.	Specifications
1	+V
2	---
3	0V
4	Output

Pin 2 is not used.

Retro-reflective Models

Pre-wired Models

E3Z-R61(K)

E3Z-R81(K)

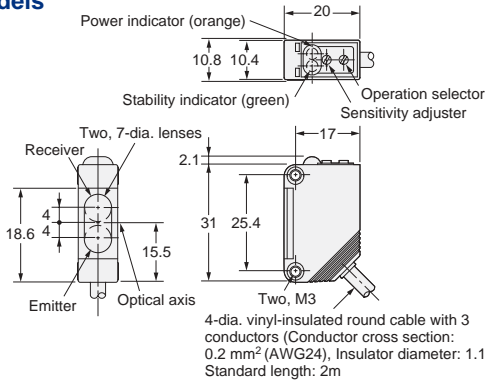

Terminal No.	Specifications
1	+V
2	---
3	0V
4	Output

Press-fit e-CON Pre-wired Connector

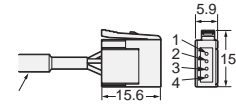

*4-dia. vinyl-insulated round cable with 3 conductors, Standard lengths: 0.3 m, 0.5 m, and 2 m

Clamp-type e-CON Pre-wired Connector (E3Z-□6□-ECON-C)

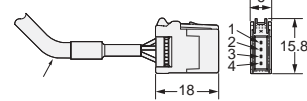

*4-dia. vinyl-insulated round cable with 3 conductors, Standard length: 2 m

M12 Pre-wired Connector (E3Z-□□□-M1J)

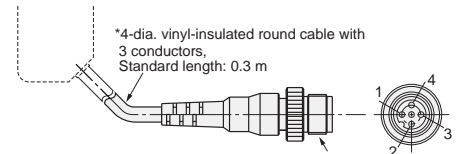

M8 Pre-wired Connector (E3Z-T□□K-M3J)

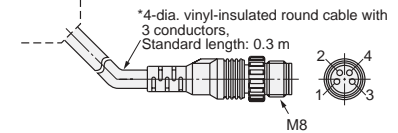

Connector Models

E3Z-R66

E3Z-R86

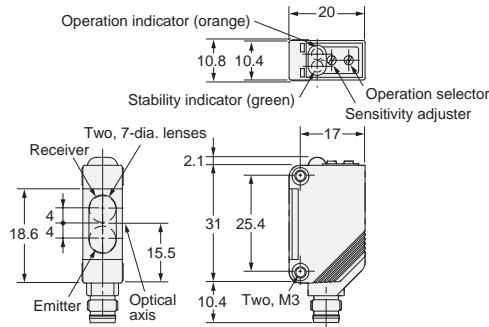

Diffuse-reflective Models

Pre-wired Models

E3Z-D61(K)

E3Z-D81(K)

E3Z-D62(K)

E3Z-D82(K)

E3Z-L61

E3Z-L81

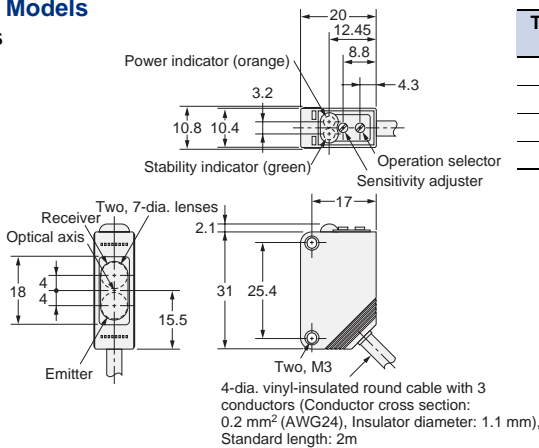

Terminal No.	Specifications
1	+V
2	---
3	0V
4	Output

Press-fit e-CON Pre-wired Connector

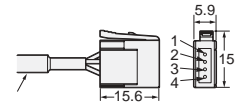

*4-dia. vinyl-insulated round cable with 3 conductors, Standard lengths: 0.3 m, 0.5 m, and 2 m

Clamp-type e-CON Pre-wired Connector (E3Z-□6□-ECON-C)

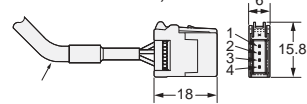

*4-dia. vinyl-insulated round cable with 3 conductors, Standard length: 2 m

M12 Pre-wired Connector (E3Z-□□□-M1J)

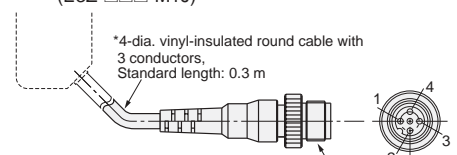

M8 Pre-wired Connector (E3Z-T□□K-M3J)

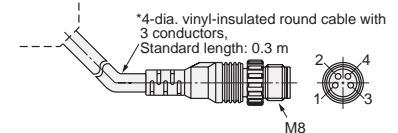

Connector Models

E3Z-D66

E3Z-D86

E3Z-D67

E3Z-D87

E3Z-L66

E3Z-L86

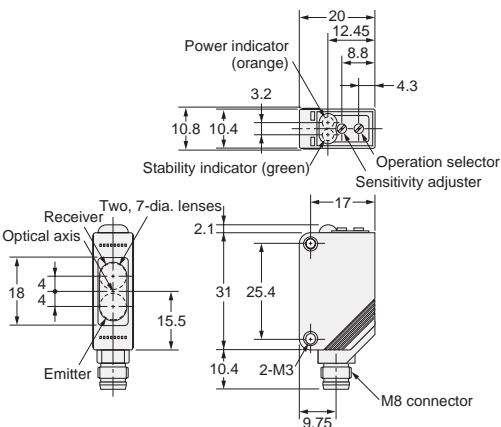

Note: The lens for the E3Z-D□1/D□6/L□□ is red. The lens for the E3Z-D□2/D□7 is black.

e-CON Connector Configurations

Wiring method	Sensor connectors
Press-fit	37104-3122-000FL (made by Sumitomo 3M)
Clamp	XN2A-1430 (made by OMRON)

Accessories (Order Separately)

Slits

E39-S65A
E39-S65B
E39-S65C

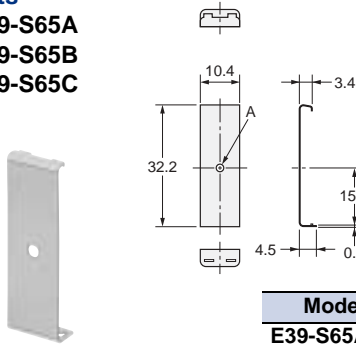

Model	Size A	Material
E39-S65A	0.5 dia.	SUS301
E39-S65B	1.0 dia.	stainless
E39-S65C	2.0 dia.	steel

Slits

E39-S65D
E39-S65E
E39-S65F

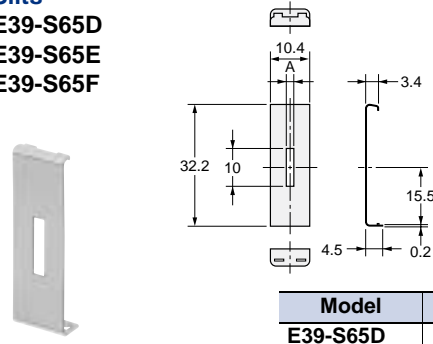

Model	Size A	Material
E39-S65D	0.5	SUS301
E39-S65E	1.0	stainless
E39-S65F	2.0	steel

Reflectors

Refer to E39-L/F39-L/E39-S/E39-R for details.

Mounting Brackets

Refer to E39-L/F39-L/E39-S/E39-R for details.

Sensor I/O Connectors

Refer to XS2 and XS3 for details.

Read and Understand This Catalog

Please read and understand this catalog before purchasing the products. Please consult your OMRON representative if you have any questions or comments.

Warranty and Limitations of Liability

WARRANTY

OMRON's exclusive warranty is that the products are free from defects in materials and workmanship for a period of one year (or other period if specified) from date of sale by OMRON.

OMRON MAKES NO WARRANTY OR REPRESENTATION, EXPRESS OR IMPLIED, REGARDING NON-INFRINGEMENT, MERCHANTABILITY, OR FITNESS FOR PARTICULAR PURPOSE OF THE PRODUCTS. ANY BUYER OR USER ACKNOWLEDGES THAT THE BUYER OR USER ALONE HAS DETERMINED THAT THE PRODUCTS WILL SUITABLY MEET THE REQUIREMENTS OF THEIR INTENDED USE. OMRON DISCLAIMS ALL OTHER WARRANTIES, EXPRESS OR IMPLIED.

LIMITATIONS OF LIABILITY

OMRON SHALL NOT BE RESPONSIBLE FOR SPECIAL, INDIRECT, OR CONSEQUENTIAL DAMAGES, LOSS OF PROFITS OR COMMERCIAL LOSS IN ANY WAY CONNECTED WITH THE PRODUCTS, WHETHER SUCH CLAIM IS BASED ON CONTRACT, WARRANTY, NEGLIGENCE, OR STRICT LIABILITY.

In no event shall the responsibility of OMRON for any act exceed the individual price of the product on which liability is asserted.

IN NO EVENT SHALL OMRON BE RESPONSIBLE FOR WARRANTY, REPAIR, OR OTHER CLAIMS REGARDING THE PRODUCTS UNLESS OMRON'S ANALYSIS CONFIRMS THAT THE PRODUCTS WERE PROPERLY HANDLED, STORED, INSTALLED, AND MAINTAINED AND NOT SUBJECT TO CONTAMINATION, ABUSE, MISUSE, OR INAPPROPRIATE MODIFICATION OR REPAIR.

Application Considerations

SUITABILITY FOR USE

OMRON shall not be responsible for conformity with any standards, codes, or regulations that apply to the combination of products in the customer's application or use of the products.

At the customer's request, OMRON will provide applicable third party certification documents identifying ratings and limitations of use that apply to the products. This information by itself is not sufficient for a complete determination of the suitability of the products in combination with the end product, machine, system, or other application or use.

The following are some examples of applications for which particular attention must be given. This is not intended to be an exhaustive list of all possible uses of the products, nor is it intended to imply that the uses listed may be suitable for the products:

- Outdoor use, uses involving potential chemical contamination or electrical interference, or conditions or uses not described in this catalog.
- Nuclear energy control systems, combustion systems, railroad systems, aviation systems, medical equipment, amusement machines, vehicles, safety equipment, and installations subject to separate industry or government regulations.
- Systems, machines, and equipment that could present a risk to life or property.

Please know and observe all prohibitions of use applicable to the products.

NEVER USE THE PRODUCTS FOR AN APPLICATION INVOLVING SERIOUS RISK TO LIFE OR PROPERTY WITHOUT ENSURING THAT THE SYSTEM AS A WHOLE HAS BEEN DESIGNED TO ADDRESS THE RISKS, AND THAT THE OMRON PRODUCTS ARE PROPERLY RATED AND INSTALLED FOR THE INTENDED USE WITHIN THE OVERALL EQUIPMENT OR SYSTEM.

PROGRAMMABLE PRODUCTS

OMRON shall not be responsible for the user's programming of a programmable product, or any consequence thereof.

Disclaimers

CHANGE IN SPECIFICATIONS

Product specifications and accessories may be changed at any time based on improvements and other reasons.

It is our practice to change model numbers when published ratings or features are changed, or when significant construction changes are made. However, some specifications of the products may be changed without any notice. When in doubt, special model numbers may be assigned to fix or establish key specifications for your application on your request. Please consult with your OMRON representative at any time to confirm actual specifications of purchased products.

DIMENSIONS AND WEIGHTS

Dimensions and weights are nominal and are not to be used for manufacturing purposes, even when tolerances are shown.

PERFORMANCE DATA

Performance data given in this catalog is provided as a guide for the user in determining suitability and does not constitute a warranty. It may represent the result of OMRON's test conditions, and the users must correlate it to actual application requirements. Actual performance is subject to the OMRON Warranty and Limitations of Liability.

ERRORS AND OMISSIONS

The information in this document has been carefully checked and is believed to be accurate; however, no responsibility is assumed for clerical, typographical, or proofreading errors, or omissions.

2009.1

In the interest of product improvement, specifications are subject to change without notice.

OMRON Corporation
Industrial Automation Company

<http://www.ia.omron.com/>

(c)Copyright OMRON Corporation 2009 All Right Reserved.