

Features

- Low On-Resistance
- Low Gate Threshold Voltage
- Low Input Capacitance
- Fast Switching Speed
- Low Input/Output Leakage
- Complementary Pair
- **Lead Free/RoHS Compliant (Note 2)**
- **"Green" Device (Note 3 and 4)**
- **Qualified to AEC-Q101 Standards for High Reliability**



TOP VIEW

SOT-363

Mechanical Data

- Case: SOT-363
- Case Material: Molded Plastic. "Green" Molding Compound. UL Flammability Classification Rating 94V-0
- Moisture Sensitivity: Level 1 per J-STD-020D
- Terminals: Solderable per MIL-STD-202, Method 208
- Lead Free Plating (Matte Tin Finish annealed over Alloy 42 leadframe).
- Terminal Connections: See Diagram
- Marking Information: See Page 5
- Ordering Information: See Page 5
- Weight: 0.008 grams (approximate)

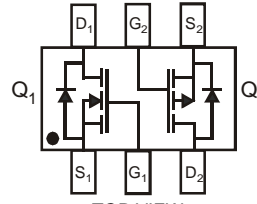
 TOP VIEW
Internal Schematic

Maximum Ratings – Total Device @T_A = 25°C unless otherwise specified

Characteristic	Symbol	Value	Units
Power Dissipation (Note 1)	P _D	200	mW
Thermal Resistance, Junction to Ambient	R _{θJA}	625	°C/W
Operating and Storage Temperature Range	T _J , T _{STG}	-55 to +150	°C

Maximum Ratings N-CHANNEL – Q₁, 2N7002 Section @T_A = 25°C unless otherwise specified

Characteristic	Symbol	Value	Units
Drain-Source Voltage	V _{DSS}	60	V
Drain-Gate Voltage R _{GS} ≤ 1.0MΩ	V _{DGR}	60	V
Gate-Source Voltage	V _{GSS}	±20 ±40	V
Drain Current (Note 1)	I _D	Continuous	115
		Continuous @ 100°C	73
		Pulsed	800

Maximum Ratings P-CHANNEL – Q₂, BSS84 Section @T_A = 25°C unless otherwise specified

Characteristic	Symbol	Value	Units
Drain-Source Voltage	V _{DSS}	-50	V
Drain-Gate Voltage R _{GS} ≤ 20KΩ	V _{DGR}	-50	V
Gate-Source Voltage	V _{GSS}	±20	V
Drain Current (Note 1)	I _D	-130	mA

- Notes:
1. Device mounted on FR-4 PCB, 1 inch x 0.85 inch x 0.062 inch; pad layout as shown on Diodes Inc. suggested pad layout document AP02001, which can be found on our website at <http://www.diodes.com/datasheets/ap02001.pdf>.
 2. No purposefully added lead.
 3. Diodes Inc.'s "Green" policy can be found on our website at http://www.diodes.com/products/lead_free/index.php.
 4. Product manufactured with Date Code UO (week 40, 2007) and newer are built with Green Molding Compound. Product manufactured prior to Date Code UO are built with Non-Green Molding Compound and may contain Halogens or Sb2O3 Fire Retardants.

Electrical Characteristics N-CHANNEL – Q₁, 2N7002 Section @ T_A = 25°C unless otherwise specified

Characteristic	Symbol	Min	Typ	Max	Unit	Test Condition
OFF CHARACTERISTICS (Note 5)						
Drain-Source Breakdown Voltage	BV _{DSS}	60	70	—	V	V _{GS} = 0V, I _D = 10μA
Zero Gate Voltage Drain Current	I _{DSS}	—	—	1.0 500	μA	V _{DS} = 60V, V _{GS} = 0V @ T _C = 25°C @ T _C = 125°C
Gate-Body Leakage	I _{GSS}	—	—	±10	nA	V _{GS} = ±20V, V _{DS} = 0V
ON CHARACTERISTICS (Note 5)						
Gate Threshold Voltage	V _{GS(th)}	1.0	—	2.5	V	V _{DS} = V _{GS} , I _D = 250μA
Static Drain-Source On-Resistance	R _{DS(ON)}	—	3.2 4.4	7.5 13.5	Ω	V _{GS} = 5.0V, I _D = 0.05A @ T _J = 25°C @ T _J = 125°C
On-State Drain Current	I _{D(ON)}	0.5	1.0	—	A	V _{GS} = 10V, V _{DS} = 7.5V
Forward Transconductance	g _{FS}	80	—	—	mS	V _{DS} = 10V, I _D = 0.2A
DYNAMIC CHARACTERISTICS						
Input Capacitance	C _{iss}	—	22	50	pF	V _{DS} = 25V, V _{GS} = 0V, f = 1.0MHz
Output Capacitance	C _{oss}	—	11	25	pF	
Reverse Transfer Capacitance	C _{rss}	—	2.0	5.0	pF	
SWITCHING CHARACTERISTICS						
Turn-On Delay Time	t _{D(ON)}	—	7.0	20	ns	V _{DD} = 30V, I _D = 0.2A,
Turn-Off Delay Time	t _{D(OFF)}	—	11	20	ns	R _L = 150Ω, V _{GEN} = 10V, R _{GEN} = 25Ω

Electrical Characteristics P-CHANNEL – Q₂, BSS84 Section @ T_A = 25°C unless otherwise specified

Characteristic	Symbol	Min	Typ	Max	Unit	Test Condition
OFF CHARACTERISTICS (Note 5)						
Drain-Source Breakdown Voltage	BV _{DSS}	-50	—	—	V	V _{GS} = 0V, I _D = -250μA
Zero Gate Voltage Drain Current	I _{DSS}	—	—	-15 -60 -100	μA μA nA	V _{DS} = -50V, V _{GS} = 0V, T _J = 25°C V _{DS} = -50V, V _{GS} = 0V, T _J = 125°C V _{DS} = -25V, V _{GS} = 0V, T _J = 25°C
Gate-Body Leakage	I _{GSS}	—	—	±10	nA	V _{GS} = ±20V, V _{DS} = 0V
ON CHARACTERISTICS (Note 5)						
Gate Threshold Voltage	V _{GS(th)}	-0.8	—	-2.0	V	V _{DS} = V _{GS} , I _D = -1mA
Static Drain-Source On-Resistance	R _{DS(ON)}	—	—	10	Ω	V _{GS} = -5V, I _D = -0.100A
Forward Transconductance	g _{FS}	.05	—	—	S	V _{DS} = -25V, I _D = -0.1A
DYNAMIC CHARACTERISTICS						
Input Capacitance	C _{iss}	—	—	45	pF	V _{DS} = -25V, V _{GS} = 0V, f = 1.0MHz
Output Capacitance	C _{oss}	—	—	25	pF	
Reverse Transfer Capacitance	C _{rss}	—	—	12	pF	
SWITCHING CHARACTERISTICS						
Turn-On Delay Time	t _{D(ON)}	—	10	—	ns	V _{DD} = -30V, I _D = -0.27A,
Turn-Off Delay Time	t _{D(OFF)}	—	18	—	ns	R _{GEN} = 50Ω, V _{GS} = -10V

Notes: 5. Short duration pulse test used to minimize self-heating effect.

N-CHANNEL – 2N7002 SECTION

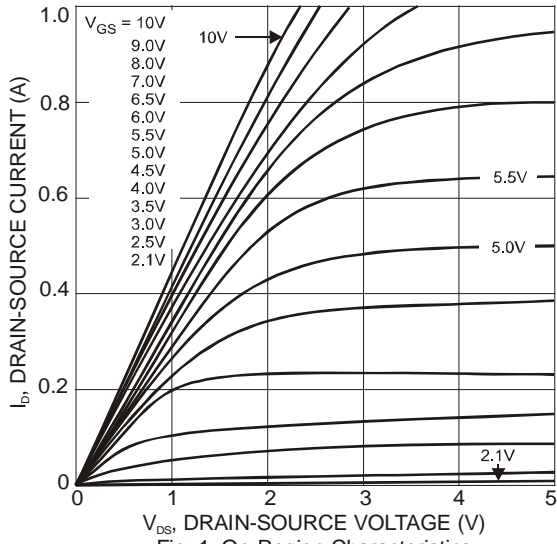

Fig. 1 On-Region Characteristics

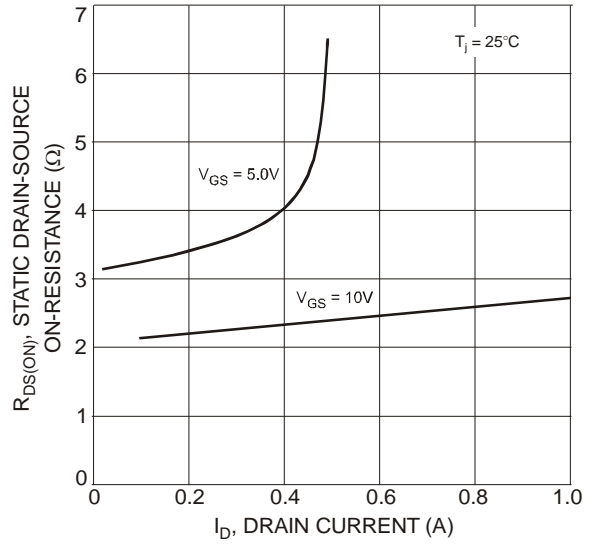

Fig. 2 On-Resistance vs. Drain Current

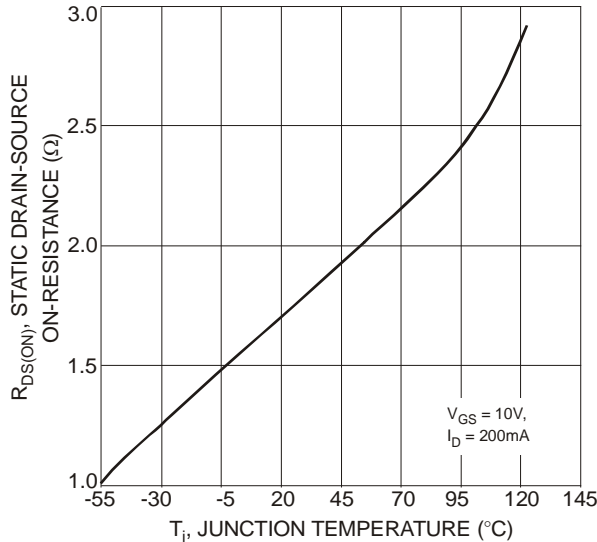

Fig. 3 On-Resistance vs. Junction Temperature

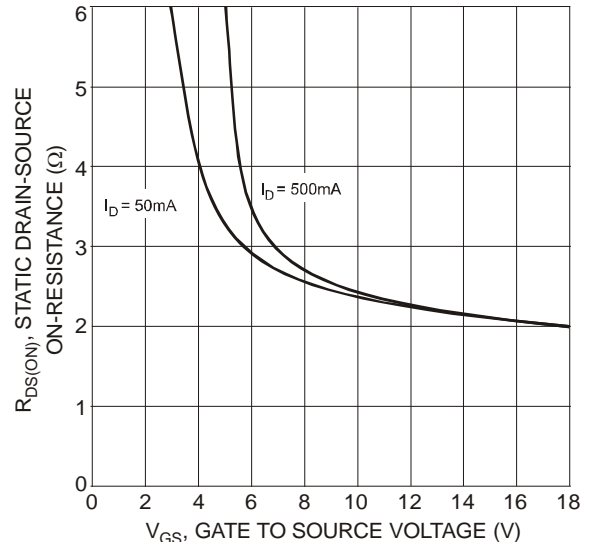

Fig. 4 On-Resistance vs. Gate-Source Voltage

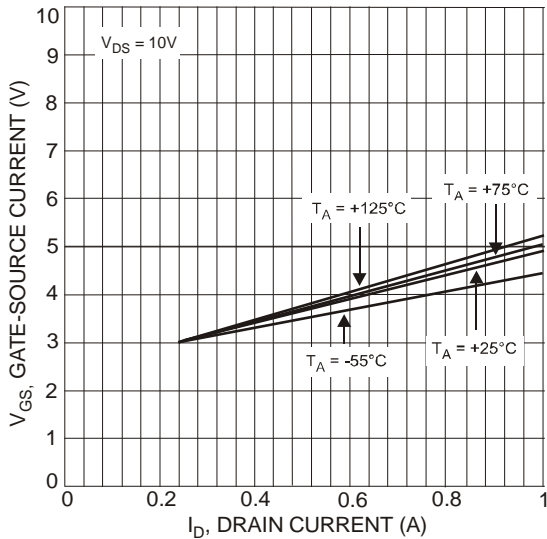

Fig. 5 Typical Transfer Characteristics

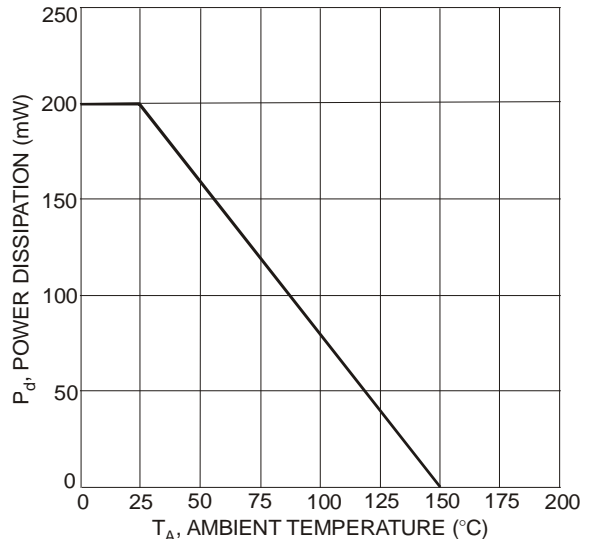

Fig. 6 Max Power Dissipation vs. Ambient Temperature

P-CHANNEL – BSS84 SECTION

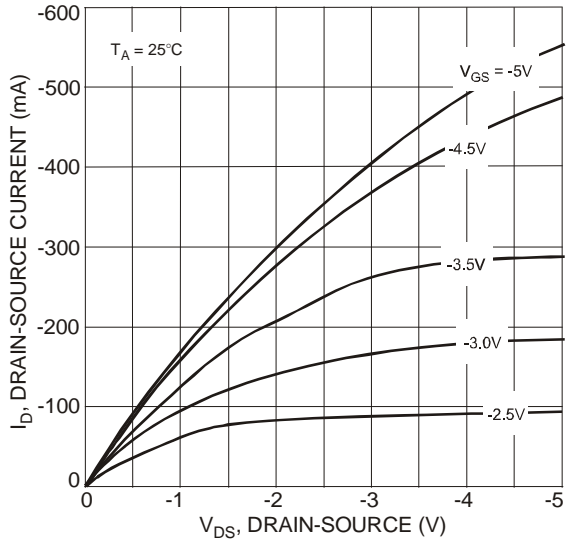

Fig. 7 Drain-Source Current vs. Drain-Source Voltage

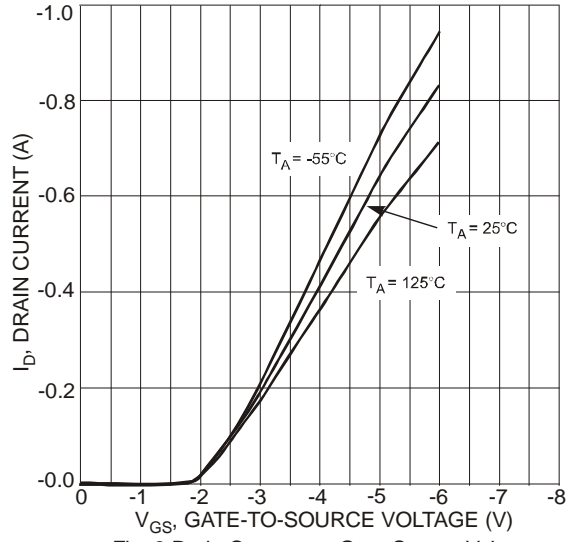

Fig. 8 Drain Current vs. Gate-Source Voltage

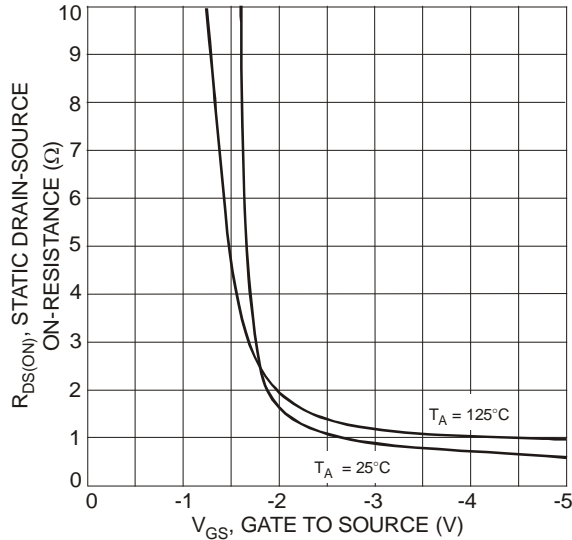

Fig. 9 On-Resistance vs. Gate-Source Voltage

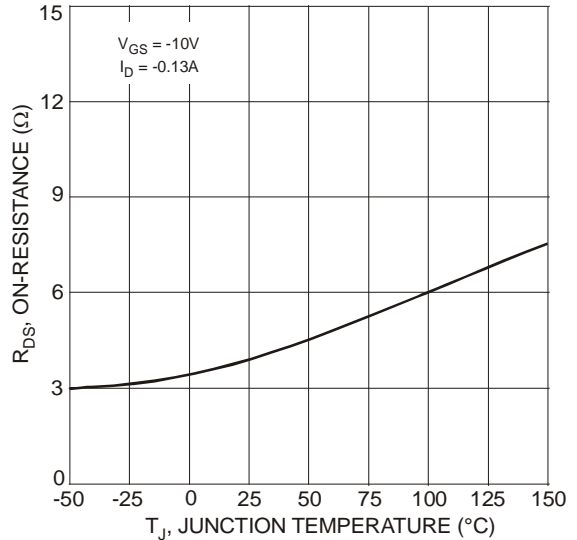

Fig. 10 On-Resistance vs. Junction Temperature

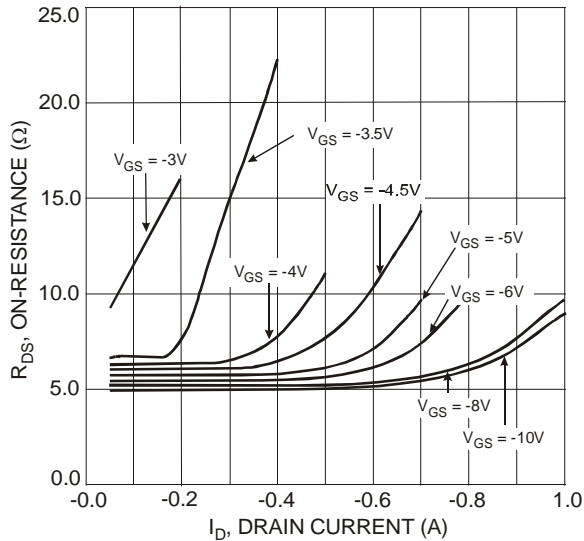

Fig. 11 On-Resistance vs. Drain Current

Ordering Information (Note 6)

Part Number	Case	Packaging
BSS8402DW-7-F	SOT-363	3000/Tape & Reel

Notes: 6. For packaging details, go to our website at <http://www.diodes.com/datasheets/ap02007.pdf>.

Marking Information

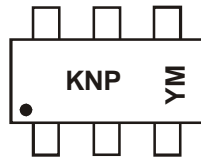

KNP = Product Type Marking Code
 YM = Date Code Marking
 Y = Year (ex: R = 2004)
 M = Month (ex: 9 = September)

Date Code Key

Year	2003	2004	2005	2006	2007	2008	2009	2010	2011	2012
Code	P	R	S	T	U	V	W	X	Y	Z

Month	Jan	Feb	Mar	Apr	May	Jun	Jul	Aug	Sep	Oct	Nov	Dec
Code	1	2	3	4	5	6	7	8	9	O	N	D

Package Outline Dimensions

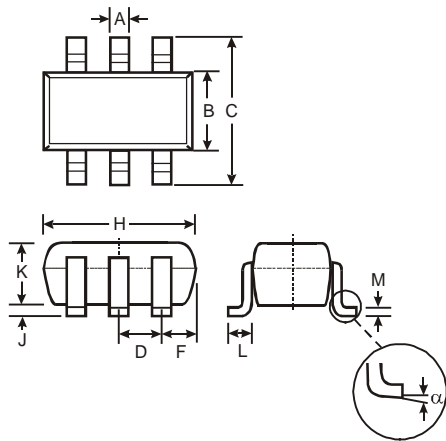

SOT-363		
Dim	Min	Max
A	0.10	0.30
B	1.15	1.35
C	2.00	2.20
D	0.65 Nominal	
F	0.40	0.45
H	1.80	2.20
J	0	0.10
K	0.90	1.00
L	0.25	0.40
M	0.10	0.22
α	0°	8°
All Dimensions in mm		

Suggested Pad Layout

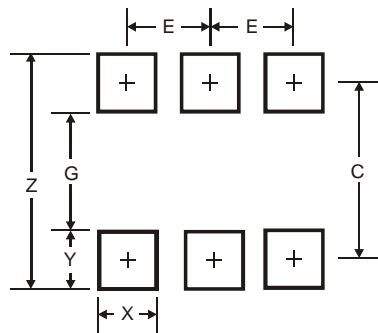

Dimensions	Value (in mm)
Z	2.5
G	1.3
X	0.42
Y	0.6
C	1.9
E	0.65

IMPORTANT NOTICE

Diodes Incorporated and its subsidiaries reserve the right to make modifications, enhancements, improvements, corrections or other changes without further notice to any product herein. Diodes Incorporated does not assume any liability arising out of the application or use of any product described herein; neither does it convey any license under its patent rights, nor the rights of others. The user of products in such applications shall assume all risks of such use and will agree to hold Diodes Incorporated and all the companies whose products are represented on our website, harmless against all damages.

LIFE SUPPORT

Diodes Incorporated products are not authorized for use as critical components in life support devices or systems without the expressed written approval of the President of Diodes Incorporated.