

REVISIONS				
REV.	ECO. NO	DESCRIPTION	DATE	BY
A	1254	INITIAL RELEASE	1-25-07	MNH

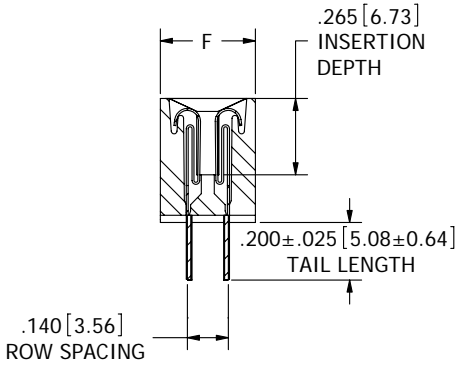

SECTION A - A

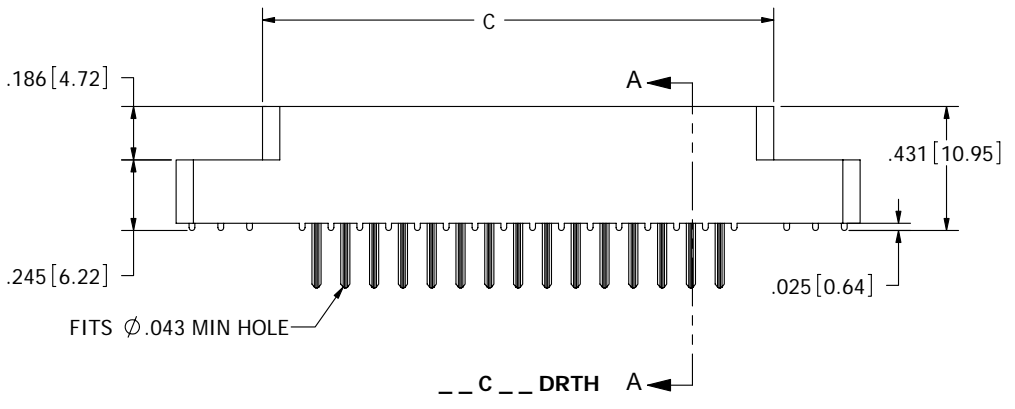
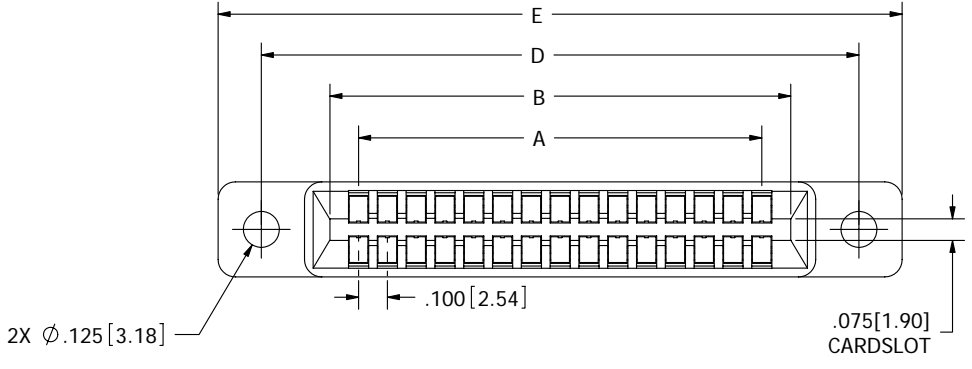
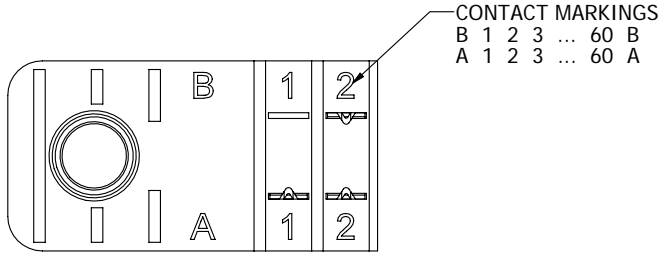

CONTACT ID
SCALE 2:1

- NOTES:
1. INSULATOR MATERIAL: SEE PART NUMBER CODING
 2. CONTACT MATERIAL: SEE PART NUMBER CODING
 3. PLATING: SEE PART NUMBER CODING
 4. OPERATING TEMPERATURE: SEE PART NUMBER CODING
 5. PROCESSING TEMP: SEE PART NUMBER CODING
 6. UL FLAMMABILITY RATING: 94V-0
 7. VOLTAGE RATING: 600 VDC MINIMUM AT SEA LEVEL.
 8. CURRENT RATING: 3 AMP PER CONTACT PAIR
 9. VOLTAGE DROP: 30 MILLI VOLT AT RATED CURRENT
 10. INSULATION RESISTANCE: 5000 MEGA OHM
 11. CONNECTOR IDENTIFICATION: THE PART SHALL BE MARKED WITH A PART NUMBER AND BARCODE
 12. BOARD THICKNESS ACCOMMODATED: .062 ± .008"
 13. BOARD INSERTION FORCE: 16 OZ MAX PER CONTACT PAIR WHEN USING A .062" TEST BLADE. INTERNAL INSPECTION TO BE PER SULLIN'S WORK INSTRUCTION W17.3-01.
 14. BOARD WITHDRAWAL FORCE: 1 OUNCE MINIMUM PER CONTACT PAIR USING .062" PCB



RoHS COMPLIANT

CUSTOMER COPY

UNLESS OTHERWISE SPECIFIED: DIMENSIONS ARE IN INCHES[MM]		DATE	NAME
TOLERANCES: ANGULAR: ± 1° XX = ± .02 [.508] .XXX = ± .005 [.1270] .XXXX = ± .0005 [.0127] PARENTHEICAL INFORMATION IS FOR REFERENCE ONLY		DRAWN	MNH
INTERPRET DIMENSIONS AND GEOMETRIC TOLERANCING PER: ANSI Y14.5-1984		THE INFORMATION HEREIN CONTAINS PROPRIETARY INFORMATION OF SULLINS ELECTRONICS AND IS NOT TO BE REPRODUCED, USED OR DISCLOSED TO OTHERS FOR ANY PURPOSE EXCEPT AS SPECIFICALLY AUTHORIZED IN WRITING BY AN OFFICER OF SULLINS ELECTRONICS.	
		SULLINS ELECTRONICS DESCRIPTION: EDGE CARD, .100 CC LP PART NUMBER - C - DRT -	
SIZE C	DWG. NO C10878	REV A	SCALE: 2:1
			SHEET 1 OF 3

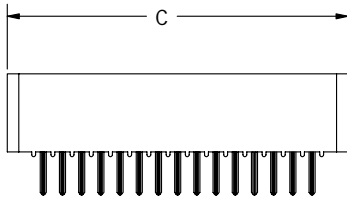
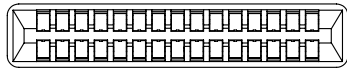

__ C __ DRTN

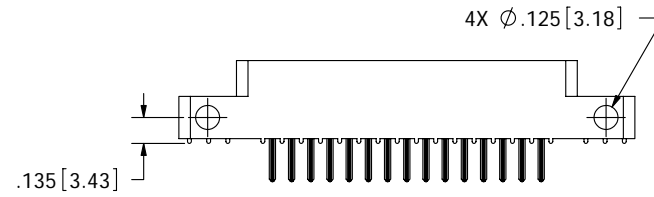
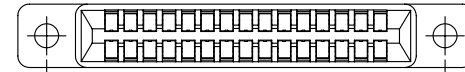

__ C __ DRTS

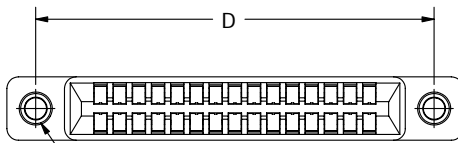

2X #4-40 THREADED INSERTS

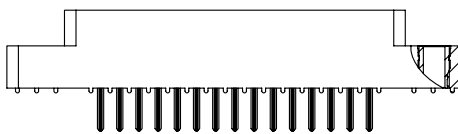

__ C __ DRTI

2X FLOATING BOBBIN
Ø .116 [2.95]
CLEARANCE FOR
4 SCREW

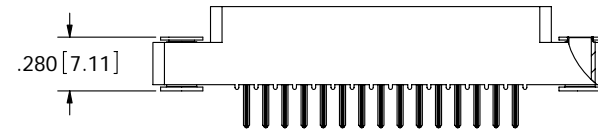
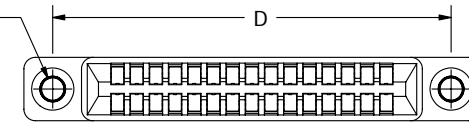

__ C __ DRTF

CUSTOMER COPY



RoHS COMPLIANT

UNLESS OTHERWISE SPECIFIED:
DIMENSIONS ARE IN INCHES[MM]
TOLERANCES:
ANGULAR: ± 1°
XX = ± .02 [.508]
.XXX = ± .005 [.1270]
.XXXX = ± .0005 [.0127]
PARENTHETICAL INFORMATION IS FOR REFERENCE ONLY

INTERPRET DIMENSIONS AND GEOMETRIC TOLERANCING PER: ANSI Y14.5-1984

DRAWN	DATE	NAME
		MNH
<small>THE INFORMATION HEREIN CONTAINS PROPRIETARY INFORMATION OF SULLINS ELECTRONICS AND IS NOT TO BE REPRODUCED, USED OR DISCLOSED TO OTHERS FOR ANY PURPOSE EXCEPT AS SPECIFICALLY AUTHORIZED IN WRITING BY AN OFFICER OF SULLINS ELECTRONICS.</small>		
SIZE	DWG. NO.	REV
C	C10878	A

SULLINS ELECTRONICS	
DESCRIPTION EDGECARD, .100 CC LP	
PART NUMBER __ C __ DRT__	
SCALE: 2:1	SHEET 2 OF 3

PART NUMBER	NO. OF POS.	A±.008[0.20]		B±.008[0.20]		C±.015[0.38]		D±.010[0.25]		E±.020[0.51]		F±.005[0.13]	
		IN	MM	IN	MM	IN	MM	IN	MM	IN	MM	IN	MM
__C04DRT__*	4	0.300	7.62	0.500	12.70	0.675	17.15	0.975	24.77	1.275	32.39	0.330	8.38
__C05DRT__	5	0.400	10.16	0.600	15.24	0.775	19.69	1.075	27.31	1.375	34.93		
__C06DRT__	6	0.500	12.70	0.700	17.78	0.875	22.23	1.175	29.85	1.475	37.47		
__C07DRT__	7	0.600	15.24	0.800	20.32	0.975	24.77	1.275	32.39	1.575	40.01		
__C08DRT__	8	0.700	17.78	0.900	22.86	1.075	27.31	1.375	34.93	1.675	42.55		
__C10DRT__	10	0.900	22.86	1.100	27.94	1.275	32.39	1.575	40.01	1.875	47.63		
__C12DRT__	12	1.100	27.94	1.300	33.02	1.475	37.47	1.775	45.09	2.075	52.71		
__C13DRT__	13	1.200	30.48	1.400	35.56	1.575	40.01	1.875	47.63	2.175	55.25		
__C15DRT__	15	1.400	35.56	1.600	40.64	1.775	45.09	2.075	52.71	2.375	60.33		
__C17DRT__	17	1.600	40.64	1.800	45.72	1.975	50.17	2.275	57.79	2.575	65.41		
__C18DRT__	18	1.700	43.18	1.900	48.26	2.075	52.71	2.375	60.33	2.675	67.95		
__C19DRT__	19	1.800	45.72	2.000	50.80	2.175	55.25	2.475	62.87	2.775	70.49		
__C20DRT__	20	1.900	48.26	2.100	53.34	2.275	57.79	2.575	65.41	2.875	73.03		
__C22DRT__	22	2.100	53.34	2.300	58.42	2.475	62.87	2.775	70.49	3.075	78.11		
__C23DRT__*	23	2.200	55.88	2.400	60.96	2.575	65.41	2.875	73.03	3.175	80.65		
__C25DRT__	25	2.400	60.96	2.600	66.04	2.775	70.49	3.075	78.11	3.375	85.73		
__C26DRT__	26	2.500	63.50	2.700	68.58	2.875	73.03	3.175	80.65	3.475	88.27		
__C28DRT__	28	2.700	68.58	2.900	73.66	3.075	78.11	3.375	85.73	3.675	93.35		
__C30DRT__	30	2.900	73.66	3.100	78.74	3.275	83.19	3.575	90.81	3.875	98.43		
__C31DRT__	31	3.000	76.20	3.200	81.28	3.375	85.73	3.675	93.35	3.975	100.97		
__C35DRT__	35	3.400	86.36	3.600	91.44	3.775	95.89	4.075	103.51	4.375	111.13		
__C36DRT__	36	3.500	88.90	3.700	93.98	3.875	98.43	4.175	106.05	4.475	113.67		
__C40DRT__	40	3.900	99.06	4.100	104.14	4.275	108.59	4.575	116.21	4.875	123.83		
__C43DRT__	43	4.200	106.68	4.400	111.76	4.575	116.21	4.875	123.83	5.175	131.45		
__C44DRT__	44	4.300	109.22	4.500	114.30	4.675	118.75	4.975	126.37	5.275	133.99		
__C49DRT__	49	4.800	121.92	5.000	127.00	5.175	131.45	5.475	139.07	5.775	146.69		
__C50DRT__	50	4.900	124.46	5.100	129.54	5.275	133.99	5.575	141.61	5.875	149.23		
__C52DRT__*	52	5.100	129.54	5.300	134.62	5.475	139.07	5.775	146.69	6.075	154.31		
__C60DRT__	60	5.900	149.86	6.100	154.94	6.275	159.39	6.575	167.01	6.875	174.63		
__C65DRT__	65	6.400	162.56	6.600	167.64	6.775	172.09	7.075	179.71	7.375	187.33		

* CONSULT FACTORY FOR AVAILABILITY

PART NUMBER CODING

MATERIAL (INSULATOR/CONTACT)

- E=PBT/PHOSPHOR BRONZE**
OPERATING TEMP: -65°C TO +125°C
PROCESSING TEMP: 260°C FOR 10 SECS MAX
- R=PPS/PHOSPHOR BRONZE**
OPERATING TEMP: -65°C TO +125°C
- G=PA9T/PHOSPHOR BRONZE**
OPERATING TEMP: -65°C TO +125°C
PROCESSING TEMP: 260°C FOR 120 SECS MAX
PROCESSING TEMP: 260°C FOR 120 SECS MAX
- H=PBT/BERYLLIUM COPPER**
OPERATING TEMP: -65°C TO +125°C
PROCESSING TEMP: 260°C FOR 10 SECS MAX
- A=PPS/BERYLLIUM COPPER**
OPERATING TEMP: -65°C TO +150°C
PROCESSING TEMP: 260°C FOR 120 SECS MAX
- J=PA9T/BERYLLIUM COPPER**
OPERATING TEMP: -65°C TO +150°C
PROCESSING TEMP: 260°C FOR 120 SECS MAX
- F=PPS/SPINODAL (CONSULT FACTORY)**
OPERATING TEMP: -65°C TO +200°C
- C=PPS/BERYLLIUM NICKEL (CONSULT FACTORY)**
OPERATING TEMP: -65°C TO +200°C
PROCESSING TEMP: 260°C FOR 120 SECS MAX
- W=PEEK/BERYLLIUM NICKEL (CONSULT FACTORY)**
OPERATING TEMP: -65°C TO +250°C

PLATING

- ALL PLATINGS HAVE .000050" NICKEL UNDERPLATE
- | | |
|--------------------------------|--------------------------|
| CONTACT SURFACE | TERMINATION |
| G = .000010" GOLD | .000005" GOLD |
| Y = .000030" GOLD | .000005" GOLD |
| B = .000010" GOLD | .000100" PURE TIN, MATTE |
| C = .000030" GOLD | .000100" PURE TIN, MATTE |
| **E = .000100" PURE TIN, MATTE | OVERALL |
| S = .000010" GOLD OVERALL | .000010" GOLD OVERALL |
| M = .000030" GOLD | |
- LEAD FREE**
**ONLY AVAILABLE ON MATERIAL CODES E, R AND G

MOUNTING STYLE

- H = .125" DIA. CLEARANCE HOLES (PAGE 1)
- I = #4-40 THREADED INSERT (PAGE 2)
- S = .125" DIA. SIDE MOUNTING (PAGE 2)
- N = NO MOUNTING EARS (PAGE 2)
- F = FLOATING BOBBIN (PAGE 2)

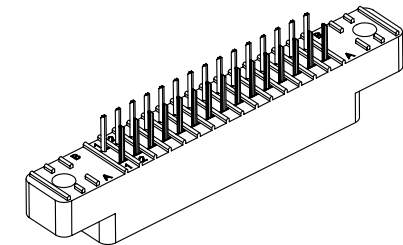
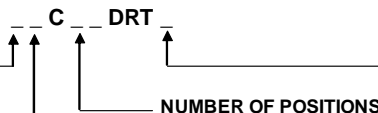

CUSTOMER COPY



RoHS COMPLIANT

UNLESS OTHERWISE SPECIFIED: DIMENSIONS ARE IN INCHES[MM]		DATE	NAME
TOLERANCES: ANGULAR: ± 1° XX = ± .02 [.508] .XXX = ± .005 [.127] XXXX = ± .0005 [.0127] PARENTHETICAL INFORMATION IS FOR REFERENCE ONLY		DRAWN	MNH
THE INFORMATION HEREIN CONTAINS PROPRIETARY INFORMATION OF SULLINS ELECTRONICS AND IS NOT TO BE REPRODUCED, USED OR DISCLOSED TO OTHERS FOR ANY PURPOSE EXCEPT AS SPECIFICALLY AUTHORIZED IN WRITING BY AN OFFICER OF SULLINS ELECTRONICS.		DESCRIPTION SULLINS ELECTRONICS	
INTERPRET DIMENSIONS AND GEOMETRIC TOLERANCING PER: ANSI Y14.5-1984		PART NUMBER EDGE CARD, .100 CC LP	
SIZE C	DWG. NO. C10878	REV A	
SCALE: 2:1		SHEET 3 OF 3	