

FEATURES

- RoHS compliant
- 0.28μH to 1.0mH
- Up to 8.7A I_{DC}
- Bobbin format
- Surface mount
- Integral EMI shield
- Compact size
- Tape and reel packaging
- UL 94V-0 materials
- J-STD-020-C reflow

DESCRIPTION

The 4600 series is a range of bobbin-wound, shielded inductors suitable for power-line filtering found in consumer electronics such as desktop computers, LED applications and GPS systems, as well as in a vast range of industrial and telecom applications including network hubs, bridges & routers, and high frequency wireless communication devices.

These surface mount inductors are extremely compact and have an integral shield, making them useful in EMI sensitive applications.

PIN CONNECTIONS (TOP VIEW)

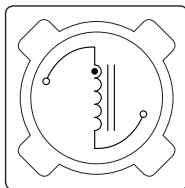

SELECTION GUIDE

| Order Code | Inductance (10kHz, 0.1V _{AC}) ±20% | DC Current ¹ | | DC Resistance |
|------------|--|-------------------------|------|---------------|
| | Nom. | Max. | Max. | Max. |
| | μH | A | mΩ | mΩ |
| 46281C | 0.28 (±30%) | 8.7 | 8 | |
| 46541C | 0.54 (±30%) | 7.7 | 10 | |
| 46102C | 1.0 (±30%) | 6.8 | 13 | |
| 46152C | 1.5 (±30%) | 6.3 | 15 | |
| 46222C | 2.2 (±30%) | 5.0 | 21 | |
| 46332C | 3.3 (±30%) | 4.3 | 29 | |
| 46472C | 4.7 (±30%) | 3.7 | 37 | |
| 46682C | 6.8 (±30%) | 3.1 | 52 | |
| 46103C | 10 | 2.4 | 66 | |
| 46153C | 15 | 2.2 | 94 | |
| 46223C | 22 | 1.8 | 120 | |
| 46333C | 33 | 1.45 | 190 | |
| 46473C | 47 | 1.25 | 260 | |
| 46683C | 68 | 1.05 | 360 | |
| 46104C | 100 | 0.86 | 500 | |
| 46154C | 150 | 0.72 | 720 | |
| 46224C | 220 | 0.57 | 1050 | |
| 46334C | 330 | 0.46 | 1850 | |
| 46474C | 470 | 0.39 | 2800 | |
| 46684C | 680 | 0.32 | 3900 | |
| 46105C | 1000 | 0.27 | 4900 | |

MECHANICAL DIMENSIONS

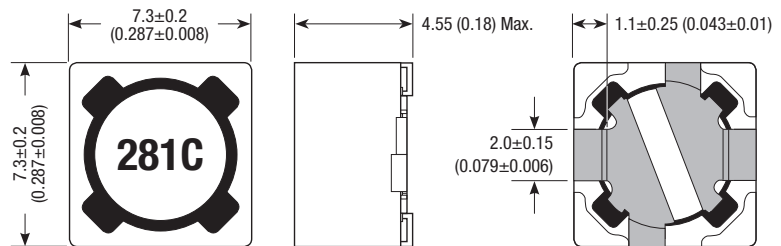

Recommended Footprint Details*

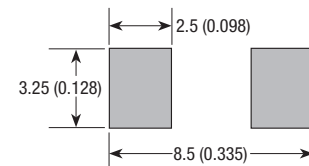

*Distance between the outside ends of the terminations is 7.1±0.1 (0.28±0.004)
Unless otherwise stated, all dimensions in mm (inches) ± 0.25 (0.010).
Package weight: 0.8g Typ.

ABSOLUTE MAXIMUM RATINGS

| | |
|-----------------------------|----------------|
| Operating temperature range | -40°C to 125°C |
| Storage temperature range | -40°C to 150°C |

SOLDERING INFORMATION²

| | |
|--------------------------------|-------|
| Peak reflow solder temperature | 250°C |
| Pin finish | Tin |

Specifications typical at T_A = 25°C

1 Maximum DC current occurs when either the inductance falls to 75% of its nominal value or when its temperature rise reaches 40°C, whichever is sooner.

2 For further information, please visit www.murata-ps.com/rohs



INDUCTANCE Vs CURRENT

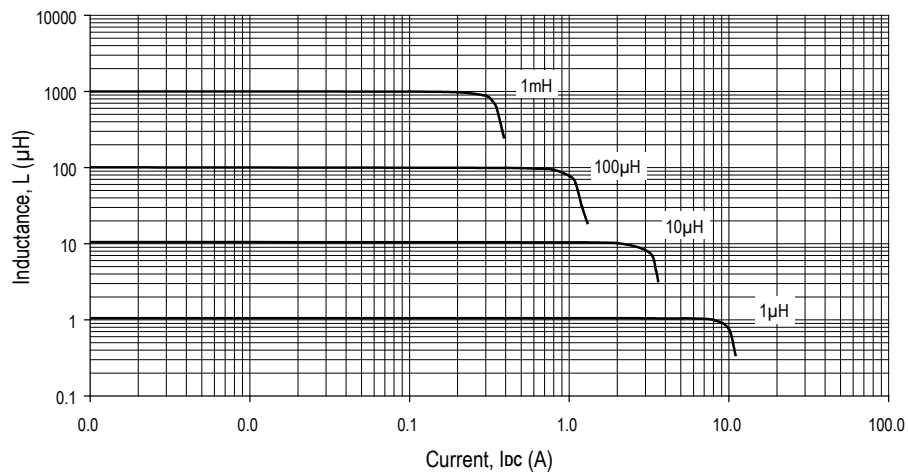

TEMPERATURE Vs CURRENT

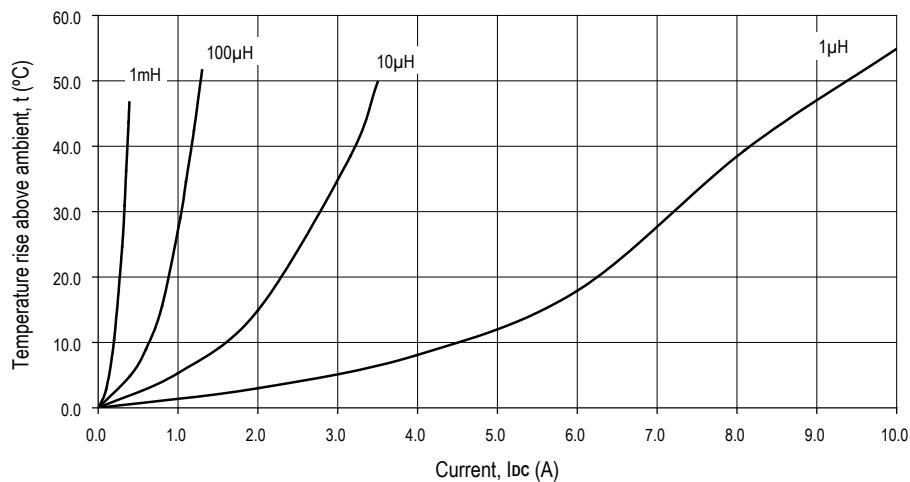

INDUCTANCE Vs FREQUENCY

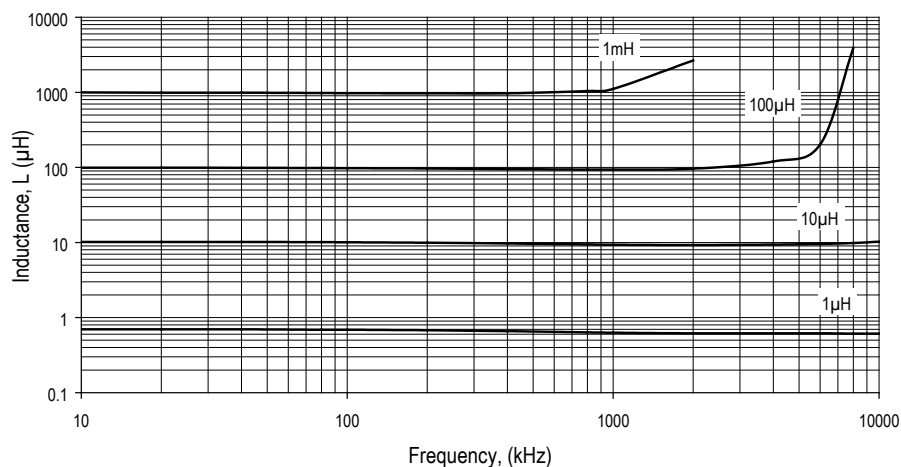

TAPE & REEL SPECIFICATIONS

REEL OUTLINE DIMENSIONS

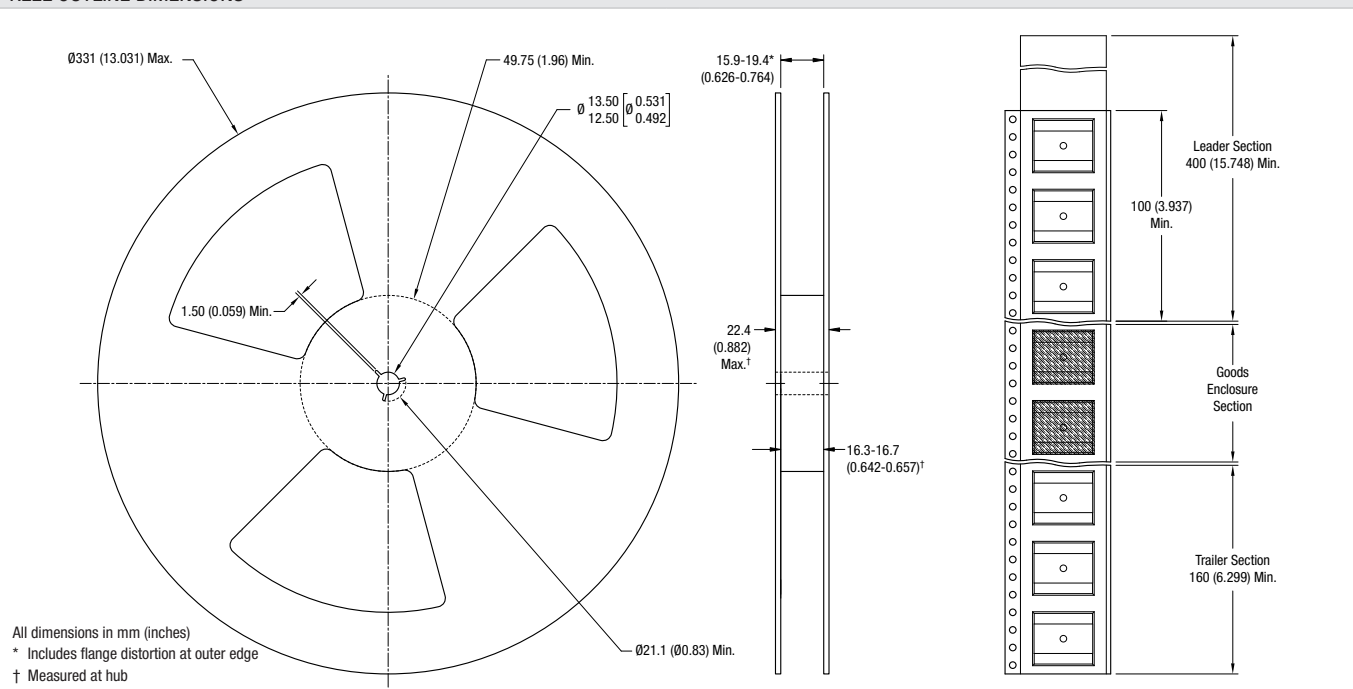

TAPE OUTLINE DIMENSIONS

