

SN74LS85

4-Bit Magnitude Comparator

The SN74LS85 is a 4-Bit Magnitude Comparator which compares two 4-bit words (A, B), each word having four Parallel Inputs (A_0 – A_3 , B_0 – B_3); A_3 , B_3 being the most significant inputs. Operation is not restricted to binary codes, the device will work with any monotonic code. Three Outputs are provided: “A greater than B” ($O_{A>B}$), “A less than B” ($O_{A<B}$), “A equal to B” ($O_{A=B}$). Three Expander Inputs, $I_{A>B}$, $I_{A<B}$, $I_{A=B}$, allow cascading without external gates. For proper compare operation, the Expander Inputs to the least significant position must be connected as follows: $I_{A<B} = I_{A>B} = L$, $I_{A=B} = H$. For serial (ripple) expansion, the $O_{A>B}$, $O_{A<B}$ and $O_{A=B}$ Outputs are connected respectively to the $I_{A>B}$, $I_{A<B}$, and $I_{A=B}$ Inputs of the next most significant comparator, as shown in Figure 1. Refer to Applications section of data sheet for high speed method of comparing large words.

The Truth Table on the following page describes the operation of the SN74LS85 under all possible logic conditions. The upper 11 lines describe the normal operation under all conditions that will occur in a single device or in a series expansion scheme. The lower five lines describe the operation under abnormal conditions on the cascading inputs. These conditions occur when the parallel expansion technique is used.

- Easily Expandable
- Binary or BCD Comparison
- $O_{A>B}$, $O_{A<B}$, and $O_{A=B}$ Outputs Available

GUARANTEED OPERATING RANGES

Symbol	Parameter	Min	Typ	Max	Unit
V_{CC}	Supply Voltage	4.75	5.0	5.25	V
T_A	Operating Ambient Temperature Range	0	25	70	°C
I_{OH}	Output Current – High			–0.4	mA
I_{OL}	Output Current – Low			8.0	mA



ON Semiconductor™

<http://onsemi.com>

LOW POWER SCHOTTKY

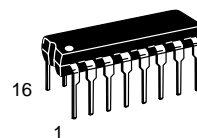

PLASTIC
N SUFFIX
CASE 648

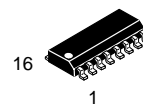

SOIC
D SUFFIX
CASE 751B

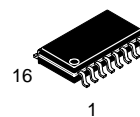

SOEIAJ
M SUFFIX
CASE 966

ORDERING INFORMATION

Device	Package	Shipping
SN74LS85N	16 Pin DIP	2000 Units/Box
SN74LS85D	SOIC–16	38 Units/Rail
SN74LS85DR2	SOIC–16	2500/Tape & Reel
SN74LS85M	SOEIAJ–16	See Note 1
SN74LS85MEL	SOEIAJ–16	See Note 1

1. For ordering information on the EIAJ version of the SOIC package, please contact your local ON Semiconductor representative.

SN74LS85

CONNECTION DIAGRAM DIP (TOP VIEW)

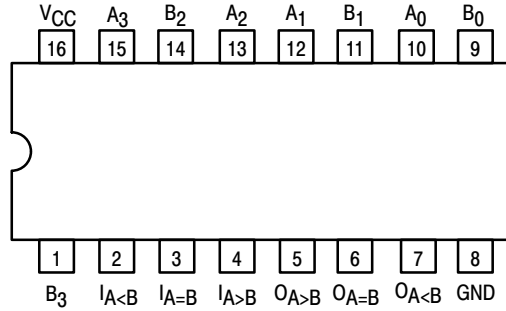

NOTE:
The Flatpak version has the same pinouts (Connection Diagram) as the Dual In-Line Package.

PIN NAMES		LOADING (Note a)	
		HIGH	LOW
$A_0 - A_3, B_0 - B_3$	Parallel Inputs	1.5 U.L.	0.75 U.L.
$I_A = B$	A = B Expander Inputs	1.5 U.L.	0.75 U.L.
$I_A < B, I_A > B$	A < B, A > B, Expander Inputs	0.5 U.L.	0.25 U.L.
$O_{A > B}$	A Greater than B Output	10 U.L.	5 U.L.
$O_{A < B}$	B Greater than A Output	10 U.L.	5 U.L.
$O_{A = B}$	A Equal to B Output	10 U.L.	5 U.L.

NOTES:

a) 1 TTL Unit Load (U.L.) = 40 μ A HIGH/1.6 mA LOW.

LOGIC SYMBOL

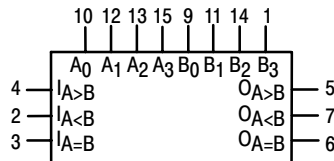

V_{CC} = PIN 16
GND = PIN 8

SN74LS85

LOGIC DIAGRAM

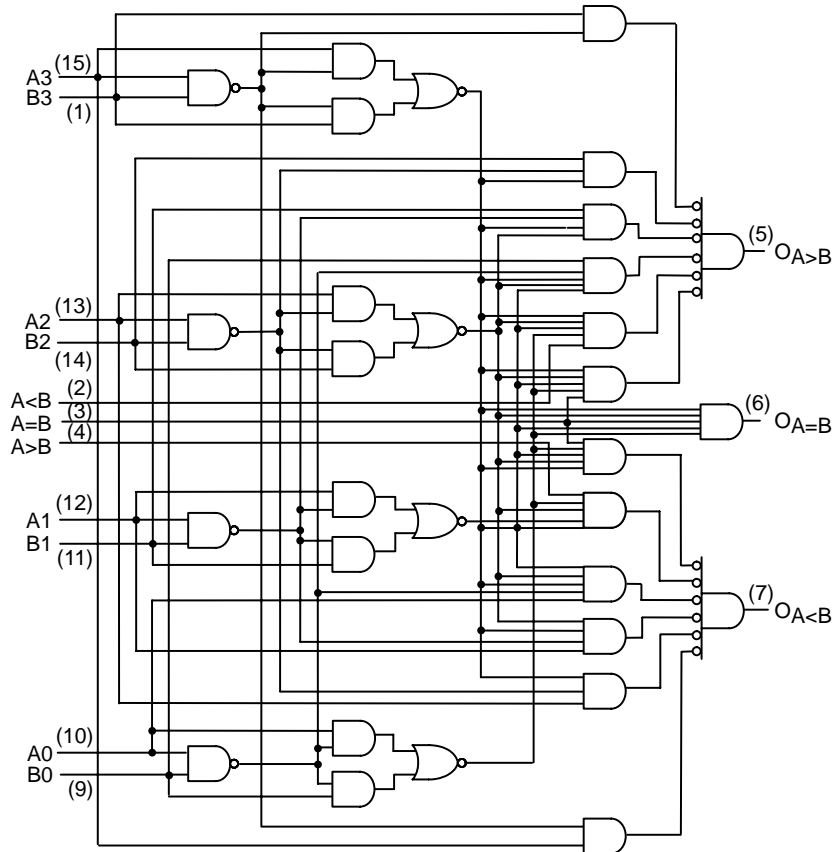

TRUTH TABLE

COMPARING INPUTS				CASCADING INPUTS			OUTPUTS		
A ₃ ,B ₃	A ₂ ,B ₂	A ₁ ,B ₁	A ₀ ,B ₀	I _{A>B}	I _{A<B}	I _{A=B}	O _{A>B}	O _{A<B}	O _{A=B}
A ₃ >B ₃	X	X	X	X	X	X	H	L	L
A ₃ <B ₃	X	X	X	X	X	X	L	H	L
A ₃ =B ₃	A ₂ >B ₂	X	X	X	X	X	H	L	L
A ₃ =B ₃	A ₂ <B ₂	X	X	X	X	X	L	H	L
A ₃ =B ₃	A ₂ =B ₂	A ₁ >B ₁	X	X	X	X	H	L	L
A ₃ =B ₃	A ₂ =B ₂	A ₁ <B ₁	X	X	X	X	L	H	L
A ₃ =B ₃	A ₂ =B ₂	A ₁ =B ₁	A ₀ >B ₀	X	X	X	H	L	L
A ₃ =B ₃	A ₂ =B ₂	A ₁ =B ₁	A ₀ <B ₀	X	X	X	L	H	L
A ₃ =B ₃	A ₂ =B ₂	A ₁ =B ₁	A ₀ =B ₀	H	L	L	H	L	L
A ₃ =B ₃	A ₂ =B ₂	A ₁ =B ₁	A ₀ =B ₀	L	H	L	L	H	L
A ₃ =B ₃	A ₂ =B ₂	A ₁ =B ₁	A ₀ =B ₀	X	X	H	L	L	H
A ₃ =B ₃	A ₂ =B ₂	A ₁ =B ₁	A ₀ =B ₀	H	H	L	L	L	L
A ₃ =B ₃	A ₂ =B ₂	A ₁ =B ₁	A ₀ =B ₀	L	L	L	H	H	L

H = HIGH Level
 L = LOW Level
 X = IMMATERIAL

SN74LS85

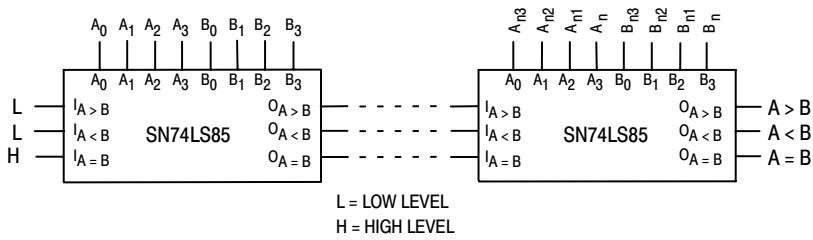

Figure 1. Comparing Two n-Bit Words

APPLICATIONS

Figure 2 shows a high speed method of comparing two 24-bit words with only two levels of device delay. With the technique shown in Figure 1, six levels of device delay result

when comparing two 24-bit words. The parallel technique can be expanded to any number of bits, see Table 1.

Table 1

WORD LENGTH	NUMBER OF PKGS.
1-4 Bits	1
5-24 Bits	2-6
25-120 Bits	8-31

NOTE:
The SN74LS85 can be used as a 5-bit comparator only when the outputs are used to drive the A₀-A₃ and B₀-B₃ inputs of another SN74LS85 as shown in Figure 2 in positions #1, 2, 3, and 4.

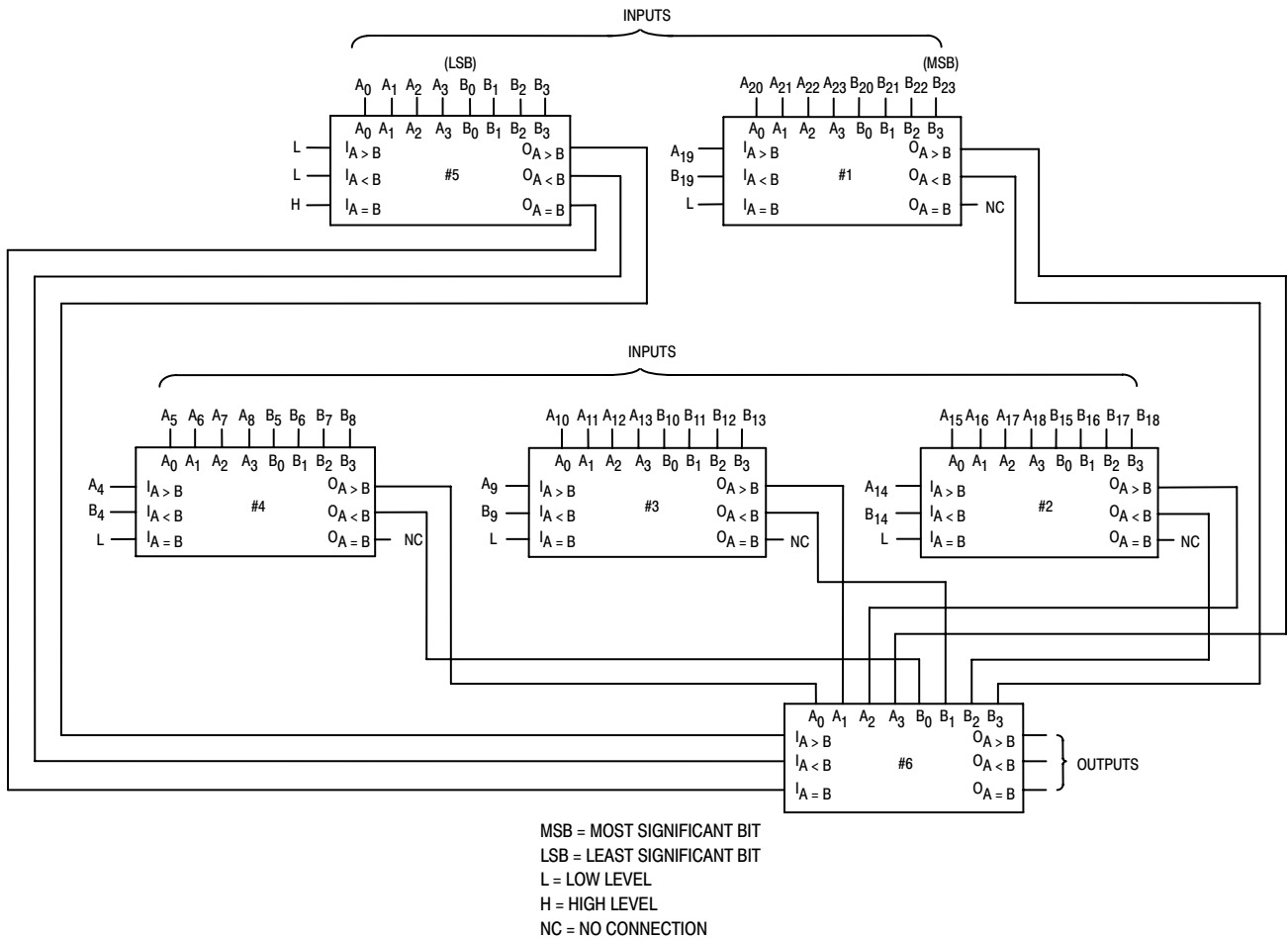

Figure 2. Comparison of Two 24-Bit Words

SN74LS85

DC CHARACTERISTICS OVER OPERATING TEMPERATURE RANGE (unless otherwise specified)

Symbol	Parameter	Limits			Unit	Test Conditions
		Min	Typ	Max		
V _{IH}	Input HIGH Voltage	2.0			V	Guaranteed Input HIGH Voltage for All Inputs
V _{IL}	Input LOW Voltage			0.8	V	Guaranteed Input LOW Voltage for All Inputs
V _{IK}	Input Clamp Diode Voltage		-0.65	-1.5	V	V _{CC} = MIN, I _{IN} = -18 mA
V _{OH}	Output HIGH Voltage	2.7	3.5		V	V _{CC} = MIN, I _{OH} = MAX, V _{IN} = V _{IH} or V _{IL} per Truth Table
V _{OL}	Output LOW Voltage		0.25	0.4	V	I _{OL} = 4.0 mA V _{CC} = V _{CC} MIN, V _{IN} = V _{IL} or V _{IH} per Truth Table
			0.35	0.5	V	
I _{IH}	Input HIGH Current A < B, A > B Other Inputs			20 60	μA	V _{CC} = MAX, V _{IN} = 2.7 V
	A < B, A > B Other Inputs			0.1 0.3	mA	V _{CC} = MAX, V _{IN} = 7.0 V
I _{IL}	Input LOW Current A < B, A > B Other Inputs			-0.4 -1.2	mA	V _{CC} = MAX, V _{IN} = 0.4 V
I _{OS}	Output Short Circuit Current (Note 2)	-20		-100	mA	V _{CC} = MAX
I _{CC}	Power Supply Current			20	mA	V _{CC} = MAX

2. Not more than one output should be shorted at a time, nor for more than 1 second.

AC CHARACTERISTICS (T_A = 25°C, V_{CC} = 5.0 V)

Symbol	Parameter	Limits			Unit	Test Conditions
		Min	Typ	Max		
t _{PLH} t _{PHL}	Any A or B to A < B, A > B		24 20	36 30	ns	V _{CC} = 5.0 V C _L = 15 pF
t _{PLH} t _{PHL}	Any A or B to A = B		27 23	45 45	ns	
t _{PLH} t _{PHL}	A < B or A = B to A > B		14 11	22 17	ns	
t _{PLH} t _{PHL}	A = B to A = B		13 13	20 26	ns	
t _{PLH} t _{PHL}	A > B or A = B to A < B		14 11	22 17	ns	

AC WAVEFORMS

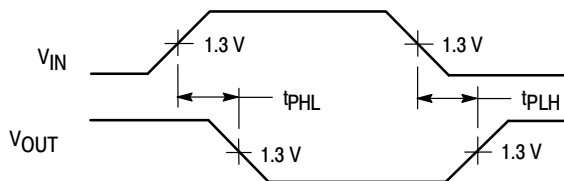

Figure 3.

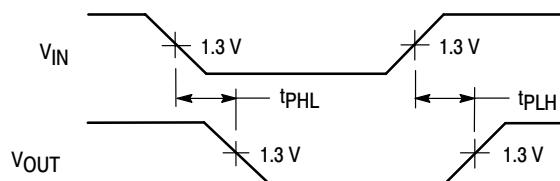
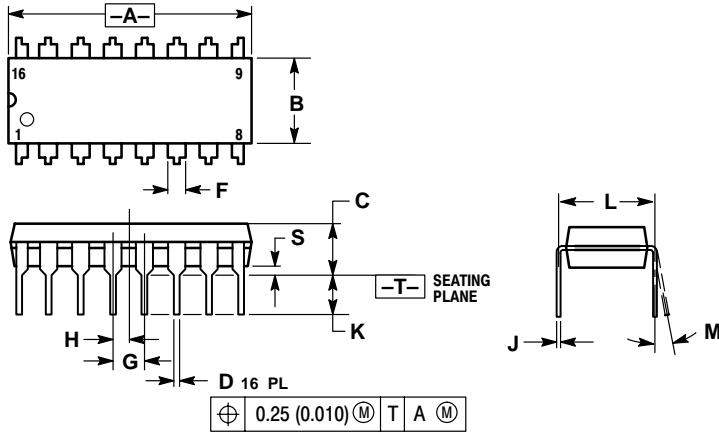

Figure 4.

SN74LS85

PACKAGE DIMENSIONS

N SUFFIX PLASTIC PACKAGE CASE 648-08 ISSUE R



NOTES:

1. DIMENSIONING AND TOLERANCING PER ANSI Y14.5M, 1982.
2. CONTROLLING DIMENSION: INCH.
3. DIMENSION L TO CENTER OF LEADS WHEN FORMED PARALLEL.
4. DIMENSION B DOES NOT INCLUDE MOLD FLASH.
5. ROUNDED CORNERS OPTIONAL.

DIM	INCHES		MILLIMETERS	
	MIN	MAX	MIN	MAX
A	0.740	0.770	18.80	19.55
B	0.250	0.270	6.35	6.85
C	0.145	0.175	3.69	4.44
D	0.015	0.021	0.39	0.53
F	0.040	0.70	1.02	1.77
G	0.100 BSC		2.54 BSC	
H	0.050 BSC		1.27 BSC	
J	0.008	0.015	0.21	0.38
K	0.110	0.130	2.80	3.30
L	0.295	0.305	7.50	7.74
M	0°		10°	
S	0.020	0.040	0.51	1.01

D SUFFIX PLASTIC SOIC PACKAGE CASE 751B-05 ISSUE J

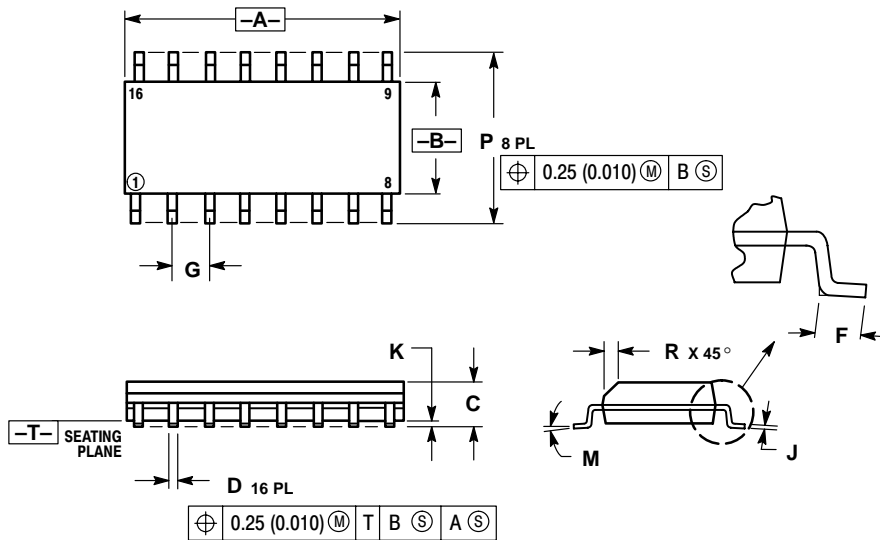

NOTES:

1. DIMENSIONING AND TOLERANCING PER ANSI Y14.5M, 1982.
2. CONTROLLING DIMENSION: MILLIMETER.
3. DIMENSIONS A AND B DO NOT INCLUDE MOLD PROTRUSION.
4. MAXIMUM MOLD PROTRUSION 0.15 (0.006) PER SIDE.
5. DIMENSION D DOES NOT INCLUDE DAMBAR PROTRUSION. ALLOWABLE DAMBAR PROTRUSION SHALL BE 0.127 (0.005) TOTAL IN EXCESS OF THE D DIMENSION AT MAXIMUM MATERIAL CONDITION.

DIM	MILLIMETERS		INCHES	
	MIN	MAX	MIN	MAX
A	9.80	10.00	0.386	0.393
B	3.80	4.00	0.150	0.157
C	1.35	1.75	0.054	0.068
D	0.35	0.49	0.014	0.019
F	0.40	1.25	0.016	0.049
G	1.27 BSC		0.050 BSC	
J	0.19	0.25	0.008	0.009
K	0.10	0.25	0.004	0.009
M	0°		7°	
P	5.80	6.20	0.229	0.244
R	0.25	0.50	0.010	0.019

SN74LS85

PACKAGE DIMENSIONS

M SUFFIX
SOEIAJ PACKAGE
CASE 966-01
ISSUE O

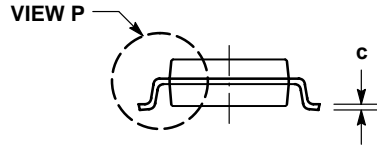
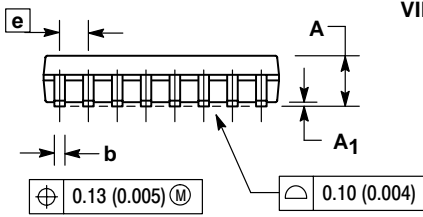
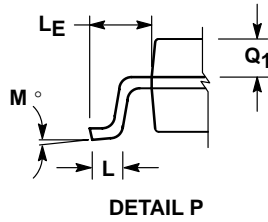
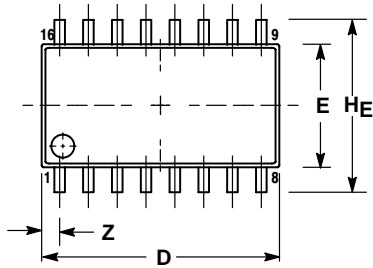

NOTES:

1. DIMENSIONING AND TOLERANCING PER ANSI Y14.5M, 1982.
2. CONTROLLING DIMENSION: MILLIMETER.
3. DIMENSIONS D AND E DO NOT INCLUDE MOLD FLASH OR PROTRUSIONS AND ARE MEASURED AT THE PARTING LINE. MOLD FLASH OR PROTRUSIONS SHALL NOT EXCEED 0.15 (0.006) PER SIDE.
4. TERMINAL NUMBERS ARE SHOWN FOR REFERENCE ONLY.
5. THE LEAD WIDTH DIMENSION (b) DOES NOT INCLUDE DAMBAR PROTRUSION. ALLOWABLE DAMBAR PROTRUSION SHALL BE 0.08 (0.003) TOTAL IN EXCESS OF THE LEAD WIDTH DIMENSION AT MAXIMUM MATERIAL CONDITION. DAMBAR CANNOT BE LOCATED ON THE LOWER RADIUS OR THE FOOT. MINIMUM SPACE BETWEEN PROTRUSIONS AND ADJACENT LEAD TO BE 0.46 (0.018).

DIM	MILLIMETERS		INCHES	
	MIN	MAX	MIN	MAX
A	---	2.05	---	0.081
A ₁	0.05	0.20	0.002	0.008
b	0.35	0.50	0.014	0.020
c	0.18	0.27	0.007	0.011
D	9.90	10.50	0.390	0.413
E	5.10	5.45	0.201	0.215
e	1.27 BSC		0.050 BSC	
HE	7.40	8.20	0.291	0.323
L	0.50	0.85	0.020	0.033
LE	1.10	1.50	0.043	0.059
M	0°	10°	0°	10°
Q ₁	0.70	0.90	0.028	0.035
Z	---	0.78	---	0.031

SN74LS85

ON Semiconductor and  are trademarks of Semiconductor Components Industries, LLC (SCILLC). SCILLC reserves the right to make changes without further notice to any products herein. SCILLC makes no warranty, representation or guarantee regarding the suitability of its products for any particular purpose, nor does SCILLC assume any liability arising out of the application or use of any product or circuit, and specifically disclaims any and all liability, including without limitation special, consequential or incidental damages. "Typical" parameters which may be provided in SCILLC data sheets and/or specifications can and do vary in different applications and actual performance may vary over time. All operating parameters, including "Typicals" must be validated for each customer application by customer's technical experts. SCILLC does not convey any license under its patent rights nor the rights of others. SCILLC products are not designed, intended, or authorized for use as components in systems intended for surgical implant into the body, or other applications intended to support or sustain life, or for any other application in which the failure of the SCILLC product could create a situation where personal injury or death may occur. Should Buyer purchase or use SCILLC products for any such unintended or unauthorized application, Buyer shall indemnify and hold SCILLC and its officers, employees, subsidiaries, affiliates, and distributors harmless against all claims, costs, damages, and expenses, and reasonable attorney fees arising out of, directly or indirectly, any claim of personal injury or death associated with such unintended or unauthorized use, even if such claim alleges that SCILLC was negligent regarding the design or manufacture of the part. SCILLC is an Equal Opportunity/Affirmative Action Employer.

PUBLICATION ORDERING INFORMATION

Literature Fulfillment:

Literature Distribution Center for ON Semiconductor
P.O. Box 5163, Denver, Colorado 80217 USA
Phone: 303-675-2175 or 800-344-3860 Toll Free USA/Canada
Fax: 303-675-2176 or 800-344-3867 Toll Free USA/Canada
Email: ONlit@hibbertco.com

N. American Technical Support: 800-282-9855 Toll Free USA/Canada

JAPAN: ON Semiconductor, Japan Customer Focus Center
4-32-1 Nishi-Gotanda, Shinagawa-ku, Tokyo, Japan 141-0031
Phone: 81-3-5740-2700
Email: r14525@onsemi.com

ON Semiconductor Website: <http://onsemi.com>

For additional information, please contact your local Sales Representative.