

THESE DRAWINGS ARE THE PROPERTY OF QUALTEK ELECTRONICS AND NOT TO BE REPRODUCED FOR OR COMMUNICATED TO A THIRD PARTY WITHOUT THE EXPRESS WRITTEN PERMISSION OF AN OFFICER OF QUALTEK ELECTRONICS.

REVISION			
REV.	DESCRIPTION	DATE	APPROVED

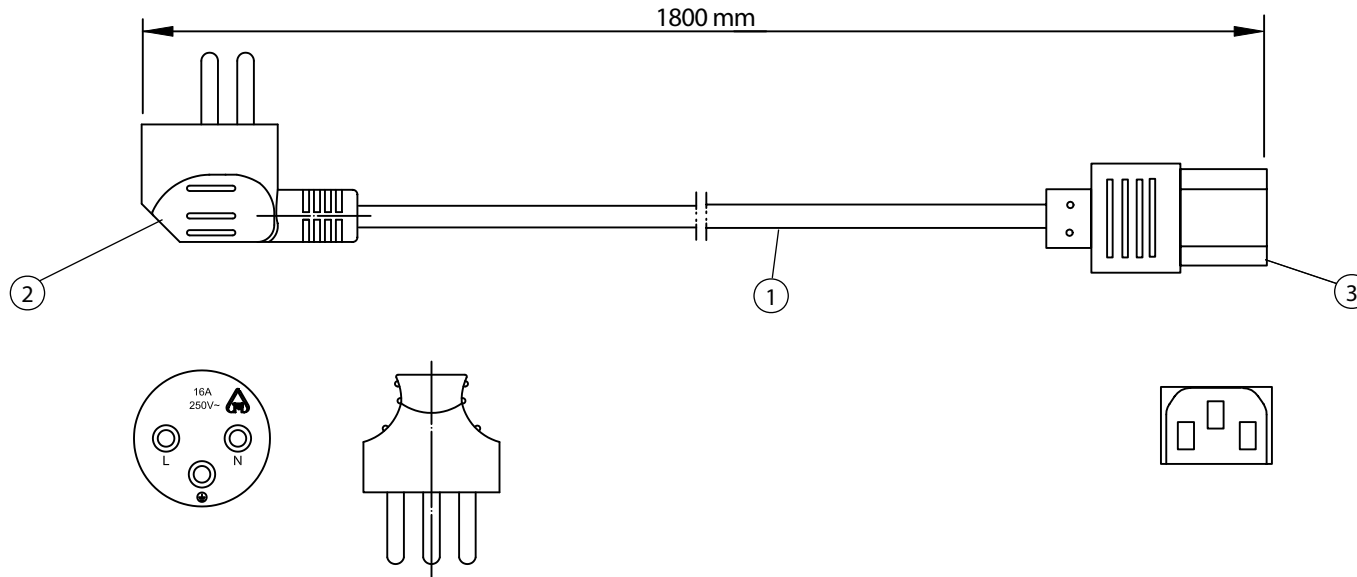

CONTROLLED

NOTES:

1. CORDAGE: H05VV-F, 3 x 1.0mm, UNSHIELDED, CEE COLOR CODE, TEMP. RATING 70°C, RATING: 250V 10A, JACKET COLOR: BLACK
2. PLUG: SI 32/ISRAEL ANGLED
3. CONNECTOR: IEC 60320 C-13
4. APPROVALS: ISRAEL
5. ROHS COMPLIANT

Dim range (mm)	Tolerance +/- (mm)	Qualtek Electronics Corp. PPC DIVISION		
0-1	0.15	Part Number: 398002-01		RoHS Compliant
1-6	0.20	Description: POWER CORD		
6-18	0.30	UNIT: mm		
18-50	0.50	Drawn / Date	Checked / Date	Approved / Date
50-120	0.70	R.Nuti 09-05-07	09-05-07	JJH / 09-05-07
120-250	0.90			
250-500	1.20			