

### 3408

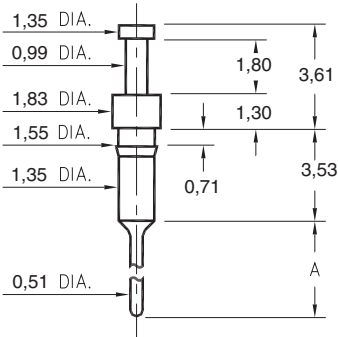

Basic Part Number	Pin Length A
3408-1	3,07
3408-2	4,60

**3408-X-00-XX-00-00-03-0**  
Press-fit in 1,45 mounting hole

### 0270/0282

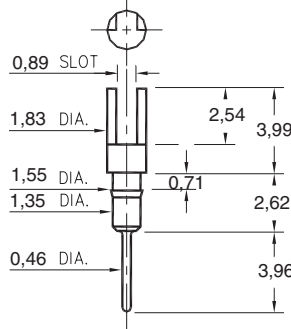

Basic Part Number	Pin Material
0270-0	Ph Br 544 (B2)
0282-0	Brass 360

**02XX-0-01-XX-00-00-03-0**  
Press-fit in 1,45 mounting hole

### 0700

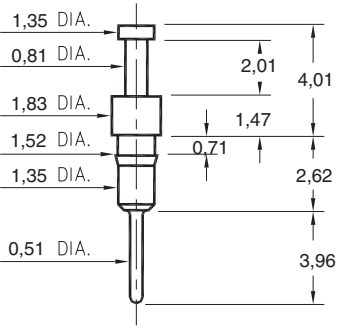

**0700-0-00-XX-00-00-03-0**  
Press-fit in 1,45 mounting hole

### 8006

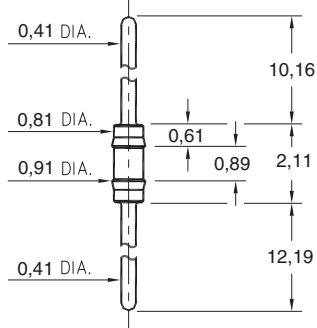

**8006-0-00-XX-00-00-03-0**  
Press-fit in 0,86 mounting hole

### 0265

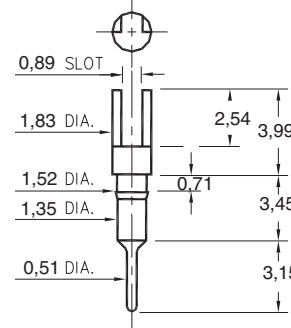

**0265-0-01-XX-00-00-03-0**  
Press-fit in 1,45 mounting hole

### 0275

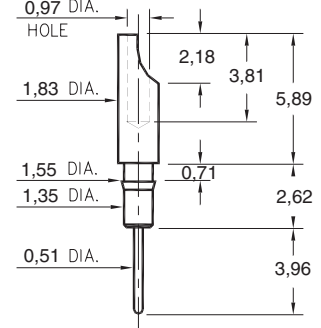

**0275-0-01-XX-00-00-03-0**  
Press-fit in 1,45 mounting hole  
Pin material is Ph. Br. 544 (B2)

### 0272

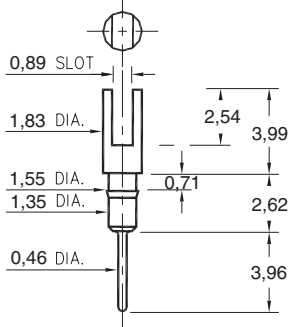

**0272-0-01-XX-00-00-03-0**  
Press-fit in 1,45 mounting hole

### 8000

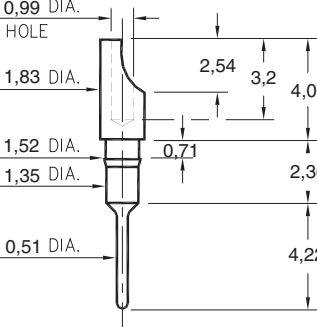

**8000-0-01-XX-00-00-03-0**  
Press-fit in 1,45 mounting hole

### 3603

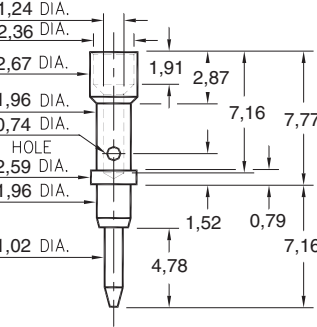

**3603-0-07-XX-00-00-08-0**  
Annealed  
#20 Crimp barrel

### 9976

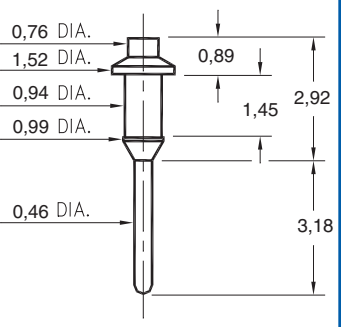

**9976-0-00-XX-00-00-03-0**  
Press-fit in 0,97 mounting hole

#### SPECIFICATIONS

**PIN MATERIAL:**  
Brass Alloy 360, 1/2 Hard  
(Except where noted)

**PART MANUFACTURED IN INCHES, METRIC FOR REF ONLY**

**TOLERANCES ON:**  
LENGTHS: ± 0,13  
DIAMETERS: ± 0,05  
ANGLES: ± 2°

**ORDER CODE: XXXX - X - 0X - XX - 00 - 00 - 0X - 0**

**BASIC PART #**

**SPECIFY PIN FINISH:**

- 01 5,08µm TIN/LEAD OVER NICKEL
- 80 5,08µm TIN OVER NICKEL
- 15 0,25µm GOLD OVER NICKEL
- 21 0,51µm GOLD OVER NICKEL
- 34 1,27µm GOLD OVER NICKEL

