

MultiCard – A Printing System for Terminals, Wires and Devices

Product Information

MultiCard

The MultiCard concept	4
Description of material	6
Tests and test procedures	7
Standards and regulations	8

Terminal markers	10
-------------------------	----

Wire and cable markers	24
-------------------------------	----

Device markers	36
-----------------------	----

Printers	41
-----------------	----

Software M-Print® PRO	45
------------------------------	----

Cable ties	46
-------------------	----

A Printing System for Terminals, Wires and Devices

Weidmüller's MultiCard concept is a standardised, innovative printing system with more than 100 marker variants for terminal connectors, wires and cables as well as devices and installations from a wide range of manufacturers.

The MultiCard marking system consists of a harmonised combination of:

MultiCard software

Using the software M-Print PRO, you can plan individual printing of single MultiCard strips. Independent of the sequences of the letters, it is possible to prepare markings for whole blocks of terminals in advance. You only need to create markers that you currently need – and in the sequence that the assembly dictates. Thus, you are able to prevent time-consuming puzzling games during installation procedures.

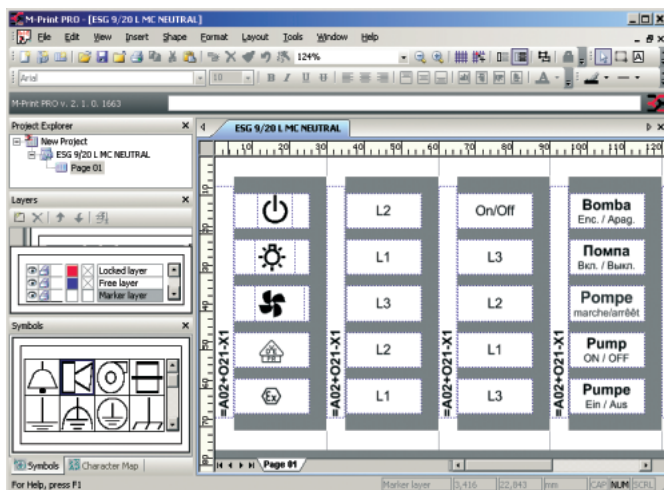

Versatile and rapid creation of individual printings through utilising the MultiCard system make it possible for you to save time and costs when marking your electrical installation.

MultiCard printers

Weidmüller specially developed the printers **PrintJet** and **SpeedMarking Laser** for the MultiCard concept. No compromises were made with regard to printing quality, printing speed or operating comfort. All of the advantages of modern-day printing technology have been optimised to suit the MultiCard system.



Your advantages

- Individual planning of markings
- No need to stock pre-printed markers

Your advantages

- Highest printing quality
- Fastest printing speed

MultiCard markers

The uniform format of the strips for individual markers forms the core of Weidmüller's MultiCard concept. Connected in strips, individual tags can easily be separated thanks to knockout perforations or mounted as a complete strip in a single action to save time.



Everything from a single source

Utilising Weidmüller's MultiCard concept allows you to create practically all markings for terminal connectors, cables and devices of various makes with a single system. The perfectly harmonised combination of software, printer and markers guarantees the best possible printing quality and rapid results. Making use of this combination from a single-source supplier, allows you to cut back your logistics and reduce your storage requirements.

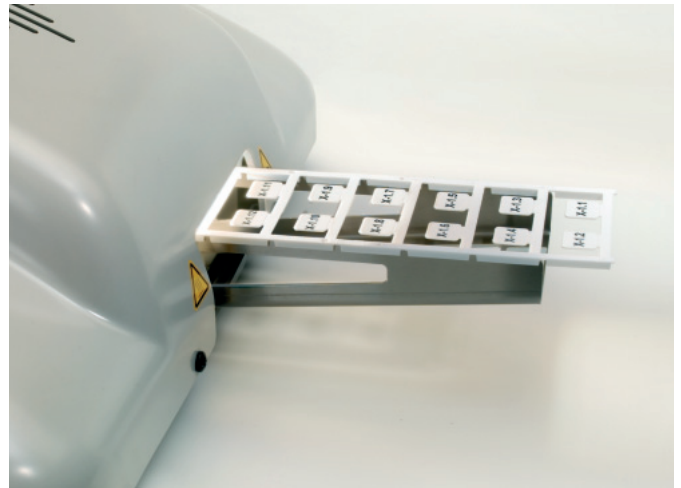

Your advantages

- Variations to suit all your marking needs
- Mount as individual tag or together in strips
- Reduce mounting times and effort
- Excellent material characteristics
- No scraping tags together during mounting

Your advantages

- Individual components – optimised to harmonise
- One printing system for all applications
- One supplier
- Cut back logistics and reduce storage requirements

Description of material

Material	Description
Polyamide	<p>Due to its good electrical and mechanical characteristics, its versatility and lack of susceptibility to fracture, polyamide (PA) is one of the most frequently used synthetic materials in technical applications. Thanks to its chemical structure, PA is also flame resistant without the addition of flame-retarding substances.</p> <p>Temperature range: -40 °C to +100 °C</p>
PVC	<p>Soft PVC is manufactured from polyvinyl chloride and plasticisers as well as additives such as stabilisers and slip agents. It is generally transparent and can be dyed in any colour. PVC is resistant to corrosive salt solutions and most acids and alkaline solutions. Due to its chemical structure, rough PVC is non-aging; it is not affected by oxygen and ozone.</p> <p>Temperature range: -30 °C to +80 °C</p>
Polypropylene	<p>Polypropylene (PP) belongs to the polyolefine group of materials. Good chemical resistance and electrical characteristics are distinguishing features of this semi-crystalline plastic. Strongly oxidising chemicals can attack PP.</p> <p>Temperature range: -40 °C to +80 °C</p>
POM	<p>Polyacetal is also known as polyoxymethylene, abbreviated to POM. Its distinguishing characteristics include a high-degree of tensile strength, hardness and stiffness across a wide temperature range.</p> <p>Temperature range: -60 °C to +110 °C</p>

Weidmüller tests and test procedures

Tests	Test conditions/requirements
Materials test	Flammability in accordance with UL94-V0 Shore A hardness test A – ISO 868 Surface resistance – DIN IEC 60093
Ageing	Due to its chemical structure, PVC is extremely non-aging; it is not affected by oxygen and ozone.
Function test of PTFE and PVC wire insulation	Suitability of markers for installation at -10 °C to +40 °C. Correct attachment test of the respective marker size for the smallest to the largest wire diameter Test for symmetry of the marker on the wire
Vibration resistance on carrier	Vibration test, industry, in accordance with: DIN EN 60068-2-6, sinusoidal (3 axes, 10 cycles per axis, acceleration 5g, frequency 10-500 Hz, sweep rate 1 octave/minute) Weidmüller test specifications – LPV 2272
Wipe resistance	Resistance of the print against the affects of hand perspiration, machine oil, water and ethanol. A slight alteration is permissible, however, clear identification (legibility) must be guaranteed. In the case of prints subject to VDE 0611 P 4 (rating plate details), the wipe resistance against water and mineral spirits is to be tested for a period of 15 minutes. Standards: DIN VDE 0611-4 / Pt. 3.1.3 DIN EN 60947-1/ Pt. 5.1 DIN EN 60742, CEI 16-7 Weidmüller test specifications – LPV 2166
Scratch resistance	No scratches must be visible on the base or the carrier following the finger-nail test. A slight alteration is permissible, however, clear identification must be guaranteed. Weidmüller test specifications – LPV 2165
UV light resistance	The function must be guaranteed. The print or colour of the product must be clearly recognisable. Standard: DIN EN ISO 4892-2; Weidmüller test specifications – LPV 2216
Chemical resistance of the print	Weidmüller test specifications – LPV 2167

Standards and regulations for markings

Safety, ease of maintenance and gain

Markers are not an end to themselves, but are a basic requirement for rapid and reliable maintenance as well as successful troubleshooting procedures. This is a particularly important under the aspect of product reliability legislation, because when damage occurs it is possible to quickly trace the possible cause. In addition, clear and unambiguous identification of electrical equipment and installations is binding for all. Standards requiring adherence are: DIN EN 60204-1 (VDE 0113 Part 1):1998-11 [1, 2] Electrical equipment of machines; Safety group standard, Type B1 in compliance with CEN classification) and DIN EN 61082-1:1995-05 [3] previously (DIN 40719-2 [4]). A further requirement: markings should be made of non-metallic materials and be resistant to oils, water, cleaning agents based on oils as well as UV radiation.

'Structured marking'

The standard DIN EN 61082-1 (VDE 0113 Part 1:1998-11 [1]) dictates that markings consist of four blocks for clear and unambiguous identification markings. If the circuit diagram lacks space, blocks not absolutely required for identification purposes can be left out. In this case, it is possible to alter the sequence of the blocks.

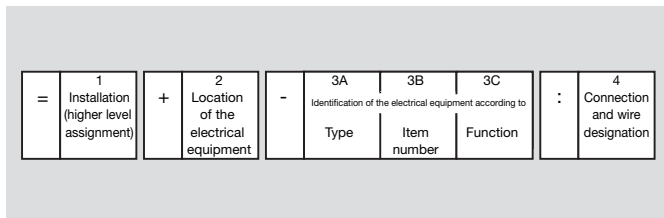

Identification block 1: 'Installation'

Block 1 with the sign '=' denotes higher level assignment. This for marking the entire installation or system. The block is divided up into five sections, which generally contain two positions. One means of differentiation is the sequence of letters and digits. There are a total of max. ten positions possible. The marking begins from the left with the largest functional unit and ends on the right with the smallest.

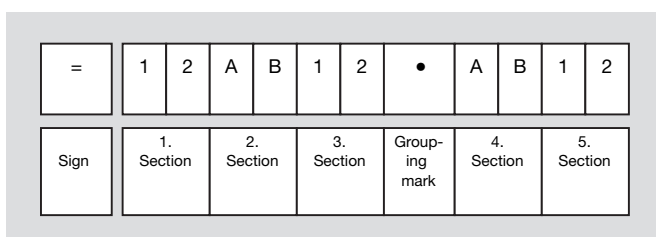

Identification block 2: 'Location of the electrical equipment'

Block 2 with the sign '+' allows for rapid localisation of the electrical equipment in larger installations. As a rule, the marking consists of letters or digits that describe the co-ordinates; they are generally divided up into six sections each with two positions (in section six there are as many as eight positions). In total, a max. of 18 positions are possible. The place of installation is to the left of the group mark, the position of installation is to the right.

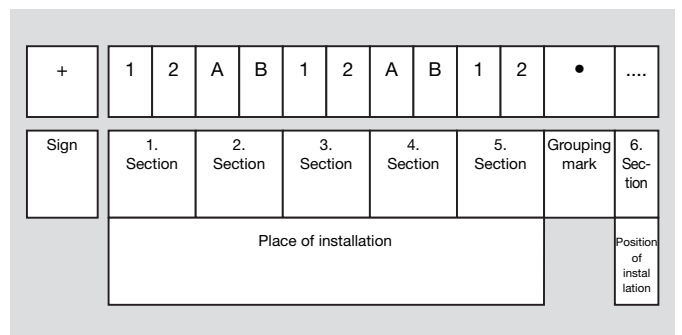

For practical purposes, the installation and location markings can be made using the 'ClipCard' device markers. The system consists of an identification system in MultiCard format as well as the card holder in an open design. The program is rounded off with a tag rail including transparent sleeves. The card holder has been designed to allow a wide variety of attachment options. The identification cards are supplied without markings. Of course, individual printing options are available.

Identification block 3: 'Type and function'

All electrical equipment is given a type identification by the manufacturer. In addition, identification block 3 with the '-' sign is a distinguishing feature providing information about the type and function of the electrical equipment. Block 3A is labelled using letters. The item number 3B provides information to help distinguish between items of equipment, should there be multiples of the same type of equipment in service or the blocks 3A and 3C are missing. Consecutive numbers can be used. Finally, it is possible to identify the function of the electrical equipment with 3C.

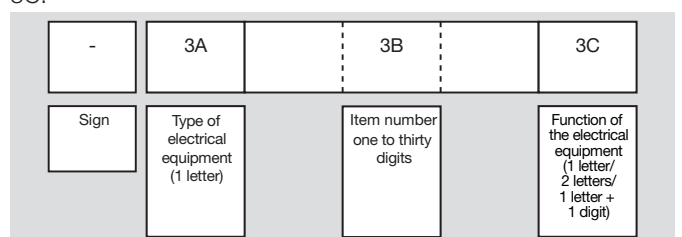

Block 3: ‘Marking of electrical equipment’

Type, item number and function are differentiated. Electrical equipment identified as devices are, for example, indicator lights, contactor relays, miniature circuit-breaker, power supplies, relay couplers, terminal blocks, interface units, starting circuit breakers and all control devices.

Examples: ‘Electrical equipment block 3A’

Type of device	Classification letter	Example
Switch for heavy current	Q	Starting circuit breaker, disconnecter, circuit-breaker
Contactor	K	Power contactor, contactor relay, relay coupler, timing relay
Protective equipment	F	Fusible links, miniature circuit-breaker, overvoltage protection, monitoring modules
Motors	M	Three-phase motor, DC motor
Transformer	U	AD converter, modules for converting an electrical quantity into a different quantity, for example, V – I, I – f switching modules
Connection elements	X	Terminal blocks, connectors, terminal boards, socket outlets, isolating plugs

Identification block 4: ‘Connection and wire designation’

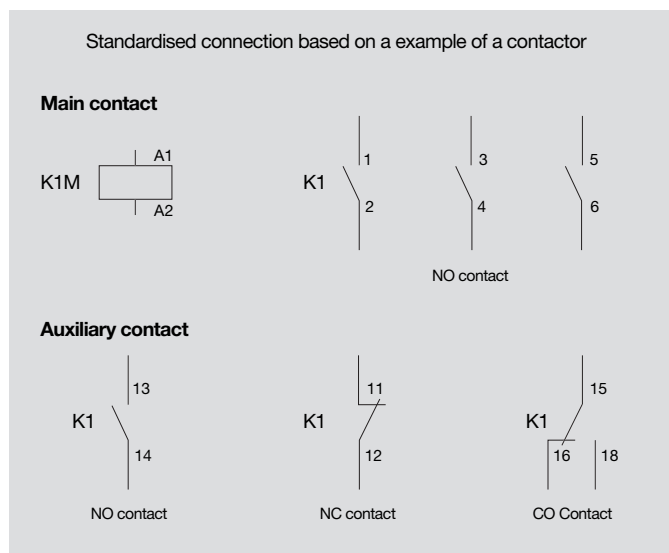

Block 4 with sign ‘:’ contains the connection and wire designation of the electrical equipment. These are laid down in standards. The companies supplying the equipment mark their devices during the manufacturing process with the corresponding designation. Where no agreement has been reached with regard to designation or the designation is not customary in practical applications, the designation of the connection is numbered sequentially.

Direction designation (external – internal)

As well as providing a clear overview of the designations of the connection points, internal and external direction designations facilitate rapid troubleshooting tasks. Wires connected to the terminal blocks are the most suitable for direction designations. Here the wire and cable markers show their worth with simple fixation onto the wire wire.

External direction designation		Terminal strip			Internal connection strip	
Designation	Connection	Connection	Symbol	Connection	Designation	Connection
Example variant 1		= K3 + S1 - X1				
= K3 + S6 - X12 : 4	1	1	⊢—	1	= K3 + S1 - F1 : 96	
Example variant 2		= K3 + S1 - X1				
= K3 + S6 - X12 : 4	1	1	⊢—	1	= K3 + S1 - F1 : 96	

Literature

- [1] DIN EN 60204-1 (VDE 0113 Part 1):1998-11 Safety of machinery - Electrical equipment of machines - Part1: General requirements. Berlin – Offenbach: VDE VERLAG (publishers) – available from www.vde-verlag.de.
- [2] IEC 60204-1:2000-05 Safety of machinery – Electrical equipment of machines – Part 1: General requirements. Genf/Switzerland: Bureau Central de la Commission Electrotechnique Internationale – available from www.iec-normen.de.
- [3] DIN EN 61082-1:1995-05 Preparation of documents used in electrotechnology – Part 1: General requirements. Berlin: Beuth – available from www.beuth.de.
- [4] Z DIN 40719-2:1973-06 circuit documentation

Markers for terminal connectors and plug-in connectors

Dekafix

Dekafix (DEK) markers are universal markers for all terminals and plug-in connectors as well as electronics modules. Including a wide range of ready-for-use prints, the system is particularly suitable for short sequences of digits.

Rapid strip mounting allows the markers to be clipped on in a single action. Available in five widths, the high-contrast print is easily legible.

- Large selection of ready-printed markers
- Rapid mounting in strips
- Terminal markers suitable for all Weidmüller terminal connectors

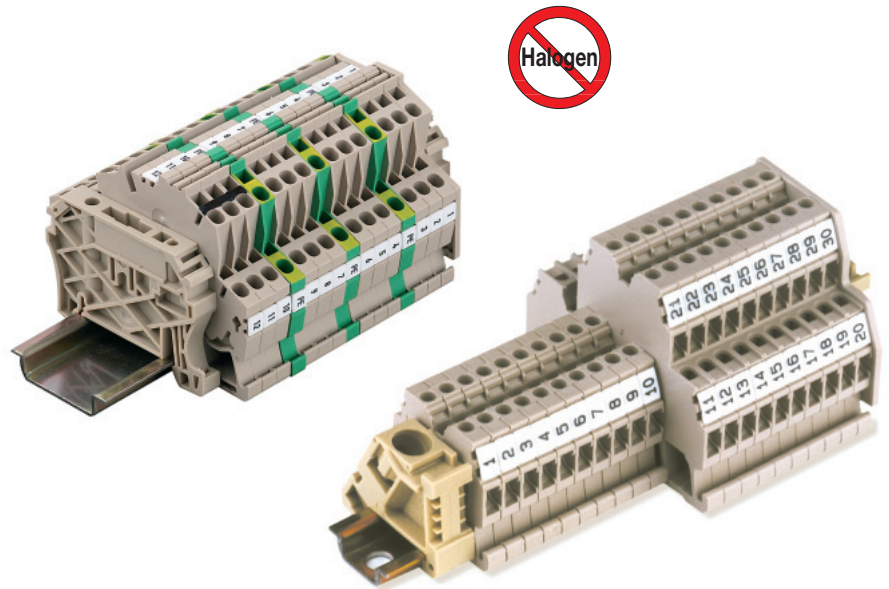

Technical data

Colour	Available in all colours of the international colour code; for MC on request ● brown, ● red, ● orange, ● yellow, ● green, ● blue, ● violet, ● grey, ○ white
Notes on mounting	Mount in strips when marker grid (width) corresponds to the grid of the terminal blocks. For example, DEK 5 mm pitch for terminals with 5-mm terminal grid; such as the WDU 2,5. Mount individual tags when the terminal grid is larger than the marker grid. For example, DEK 6.5 mount individually on WDU 6. Weidmüller markers with 5-mm grid (width) suitable for all widths of terminals.
Possible printing systems	Plotter, SMark-Laser, PrintJet, MC-Mobilo

Ordering information

MultiCard

Minimum order quantity	1 Qty.
Package	Cardboard box

Number of characters when using plotter font

Pin size	0.18	0.25	0.35	0.18	0.25	0.35
Typeface (pt)	10	10	10	4	5	6
Tag width (mm) 3.5	2	2	2	5	4	3
Tag width (mm) 5	2	2	2	5	4	3
Tag width (mm) 6	2	2	2	6	5	4
Tag width (mm) 6.5	3	3	3	7	5	4
Tag width (mm) 8	4	4	4	9	7	6

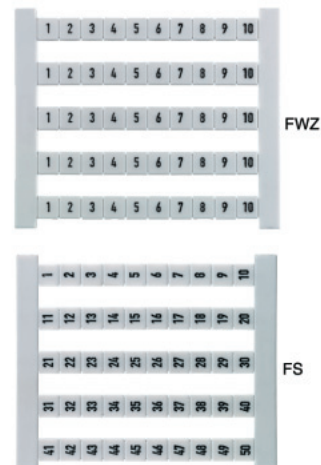
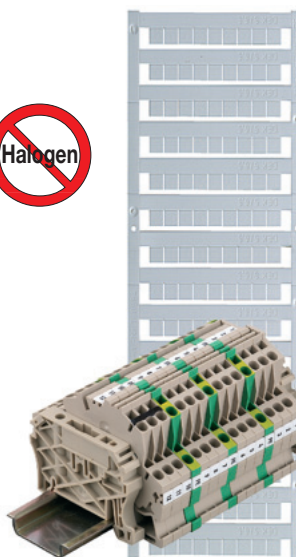

Technical data

Material	Polyamide
Flammability class to UL94	V2
Temperature range °C	-40...100

Terminal width 3.5 mm DEK

Type	Length [mm]	Qty.	Order No.
Neutral white			
DEK 5/3,5 MC	5	500	1755270000
Custom print white			
DEK 5/3,5 MC	5	100	1767730000

Terminal width 6 mm DEK

Type	Length [mm]	Qty.	Order No.
Neutral white			
DEK 5/6 MC	5	1000	1609820000
Custom print white			
DEK 5/6 MC	5	200	1609830000

Terminal width 7.5 mm DEK

Type	Length [mm]	Qty.	Order No.
Neutral white			
DEK 5/7,5 MC	5	320	1720620000
Custom print white			
DEK 5/7,5 MC	5	320	1770490000

Terminal width 5 mm DEK

Type	Length [mm]	Qty.	Order No.
Neutral white			
DEK 5/5 MC	5	1000	1609801044
DEK 5/5 Plus MC	5	1000	1854490000
Custom print white			
DEK 5/5 MC	5	200	1609810000
DEK 5/5 Plus	5	200	1854500000

Terminal width 6.5 mm DEK

Type	Length [mm]	Qty.	Order No.
Neutral white			
DEK 5/6,5 MC	5	900	1609840000
Custom print white			
DEK 5/6,5 MC	5	180	1609850000

Terminal width 8 mm DEK

Type	Length [mm]	Qty.	Order No.
Neutral white			
DEK 5/8 MC	5	800	1856740000
Custom print white			
DEK 5/8 MC	5	500	1856750000

Terminal markers

WS/ZS

WS markers have been optimised for W-Series terminal connectors. Thanks to their system compatibility, WS tags can be used for products from the I-Series and the Z-Series. The large marking surface is suitable for long sequences of characters as well as several lines of information.

WS markers are particularly suitable for marking lengthier, individually created sequences of characters. The proven MultiCard format means it is possible to print with any of the printers Laser, PrintJet, Plotter or MC-Mobilo.

- Mount in strips or individually
- Markers available in the proven MultiCard format

ZS

ZS markers – available in the proven MultiCard format – have been specially developed for the Z-Series. They offer a large marking surface. The hinged mechanism even allows access to cross-connectors without having to dismount the markers first. Snap-on attachment of individual tags in strips guarantees rapid mounting. The individual tags can easily be separated from the strips.

- Hinged marker surface
- Mount in strips or individually
- Markers available in the proven MultiCard format

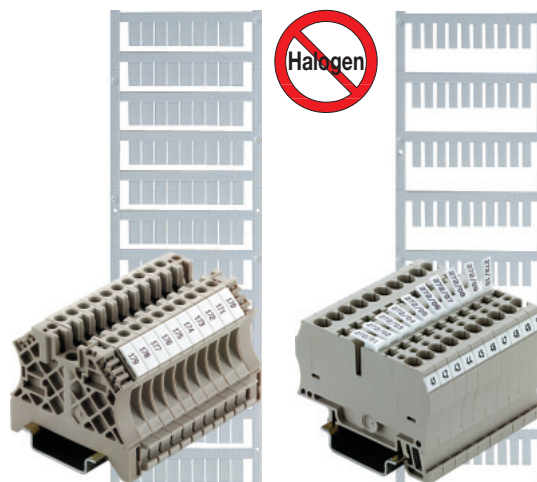

Technical data

WS

Colour	Available in all colours of the international colour code; for MC on request ● brown, ● red, ● orange, ● yellow, ● green, ● blue, ● violet, ● grey, ○ white
Notes on mounting	Mount in strips when marker grid (width) corresponds to the grid of the terminal blocks. For example, WS 10/6 = 6-mm terminal grid For terminals with 6-mm terminal grid such as WDU 4 Mount individual tags when the terminal grid is larger than the marker grid. For example, WS 12/6.5 mount individually on WDU 6 Weidmüller markers with 5-mm grid (width) suitable for all widths of terminals.

ZS

Colour	white
Notes on mounting	Height x width (terminal grid) Example: ZS 10/5 10 mm in height, 5 mm width = 5 mm grid
Possible printing systems	Plotter, SMark-Laser, PrintJet, MC-Mobilo

Ordering information

WS and ZS MultiCard

Definition of quantity	1 strip
Minimum order quantity	1 Qty.

WS card

WS .../5 only	
Definition of quantity	1 card = 30 items
Minimum order quantity	1 Qty.

Number of characters when using plotter font

WS

Pin size	0.18	0.25	0.35	0.18	0.25	0.35
Typeface (pt)	10	10	10	4	5	6
Tag width (mm)	8	4	4	4	9	7
Tag width (mm)	10	4	4	4	11	9
Tag width (mm)	12	5	5	5	13	11
Tag width (mm)	15	7	7	7	17	14

ZS

Pin size	0.18	0.25	0.35	0.18	0.25	0.35
Typeface (pt)	10	10	10	4	5	6
Tag width (mm)	10	4	4	4	11	9
Tag width (mm)	12	5	5	5	13	11
Tag width (mm)	15	7	7	7	17	14
Carrier system (mm)	Z-Series, W-Series, SAK Series					

Ordering data

Terminal width ≥ 5 mm			
Type	Print	Qty.	Order No.
WS 8...15/5			
WS 12/5	FSZ 1 - 10	300	1773430001
WS 12/5	FSZ 11 - 20	300	1773430011
WS 12/5	FSZ 21 - 30	300	1773430021
WS 12/5	FSZ 31 - 40	300	1773430031
WS 12/5	FSZ 41 - 50	300	1773430041
WS 12/5			
WS 12/5	FWZ 1 - 10	300	1773330001
WS 12/5	FWZ 11 - 20	300	1773330011
WS 12/5	FWZ 21 - 30	300	1773330021
WS 12/5	FWZ 31 - 40	300	1773330031
WS 12/5	FWZ 41 - 50	300	1773330041

Ordering data WS cards – standard print

Ordering data

Terminal width ≥ 5 mm			
Type	Print	Qty.	Order No.
WS 8...15/5			
WS 8/5 card		300	1773360000
WS 10/5 card		300	1773370000
WS 12/5 card		300	1773380000
Colour variations on request			

WS card – Custom print to specifications

Technical data

Material	Polyamide
Flammability class to UL94	V2
Temperature range °C	-40...100

WS 10/5 Middle and 10/6 Middle are equipped with a centred foot.

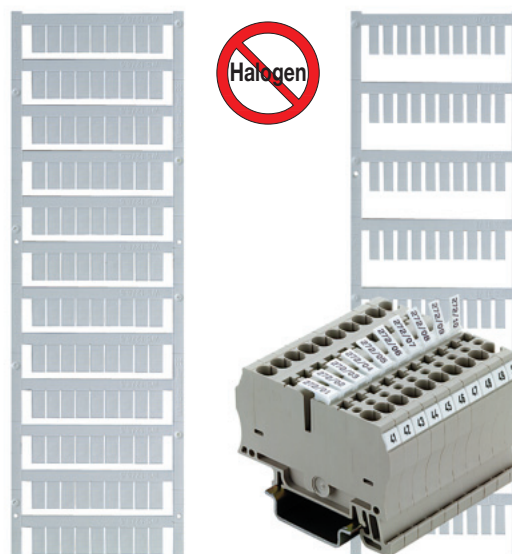

Terminal width 3.5 mm WS/ZS

Type	Length [mm]	Qty.	Order No.
Neutral white			
WS 12/3,5 MC	12	600	1778270000
Custom print white			
WS 12/3,5 MC	12	120	1778280000

Terminal width 6 mm WS/ZS

Type	Length [mm]	Qty.	Order No.
Neutral white			
WS 10/6 MC	10	600	1828450000
WS 10/6 MC Middle	10	600	1818400000
WS 12/6 MC	12	600	1609900000
Custom print white			
WS 10/6 MC	10	120	1828460000
WS 10/6 MC Middle	10	120	1818410000
WS 12/6 MC	12	120	1609910000

Terminal width 5 mm WS/ZS

Type	Length [mm]	Qty.	Order No.
Neutral white			
ZS 10/5 MC	10	480	1610000000
ZS 15/5 MC	15	480	1646630000
Custom print white			
ZS 10/5 MC	10	96	1610010000
ZS 15/5 MC	15	96	1646640000

Terminal width 5 mm WS/ZS

Type	Length [mm]	Qty.	Order No.
Neutral white			
WS 8/5 MC	8	720	1640740000
WS 10/5 MC	10	720	1635000000
WS 10/5 MC Middle	10	720	1792000000
WS 12/5 MC	12	720	1609860000
WS 14/5 MC	14	480	1768090000
WS 15/5 MC	15	480	1609880000
Custom print white			
WS 8/5 MC	8	144	1640750000
WS 10/5 MC	10	144	1635010000
WS 10/5 MC Middle	10	144	1792010000
WS 12/5 MC	12	144	1609870000
WS 15/5 MC	15	96	1609890000

Terminal width 6.5 mm WS/ZS

Type	Length [mm]	Qty.	Order No.
Neutral white			
WS 12/6,5 MC	12	540	1609920000
Custom print white			
WS 12/6,5 MC	12	108	1609930000

Terminal width 6 mm WS/ZS

Type	Length [mm]	Qty.	Order No.
Neutral white			
ZS 12/6 MC	12	400	1610020000
Custom print white			
ZS 12/6 MC	12	80	1610030000

Terminal markers





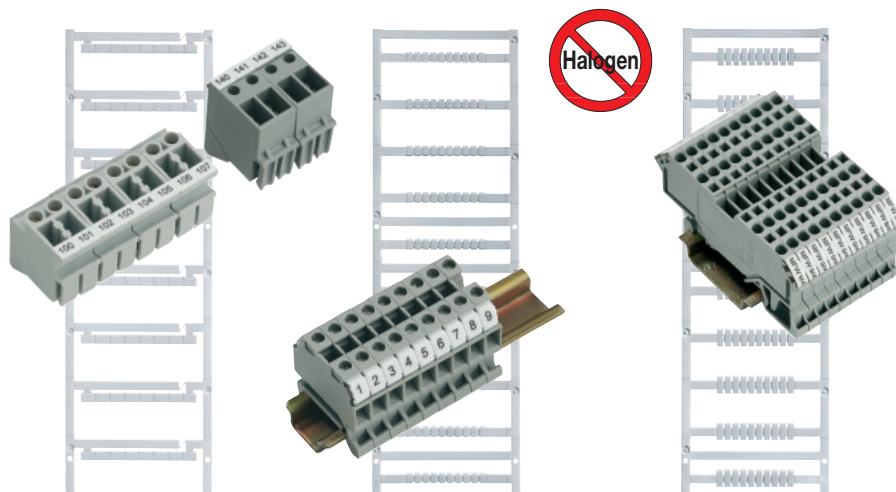

MultiFit MF





MultiFit is Weidmüller's marker system for use with other makes of terminals with grids of 4 (NEW), 5, 6, 7.5 (NEW), 8 and 10 mm.

- Neutral markers for user to print with SMark-Laser, PrintJet, Plotter or MC-Mobilo
- Individually printed markers supplied based on customer CAD data or specifications
- One marker suitable for various makes of terminals



Application options

							
Wago	●	●	●		● Similar to the WagoMini WSB Type 248-...264-...	● Similar to the Wago WSB Type 209-...249-...	● Similar to the Wago WMB Type 793-...794-...
Phoenix	●	●	●	● MF 5/5 Similar to the Phoenix Contact ZBF 5 MF 5/6 Similar to the Phoenix Contact ZBF 6 MF 5/4 Similar to the Phoenix ZBF 4			
Wieland	●	●	●				
Legrand	●	●	●		●	●	●
entrelec	●	●	●		●		
Télémechanique	●	●	●				

				
Wago				
Phoenix	● ZB 8	● ZB 10	● BN-ZB 7,5	
Wieland				
Legrand				
entrelec	●	●		
Télémechanique				
Adels RKW			● BZ 14	
Cabur				● Cabur

● = OK

(Please select the marker according to the width of the terminal)

Number of characters when using plotter font

Pin size	0.18	0.25	0.35	0.18	0.25	0.35
Typeface (pt)	10	10	10	4	5	6
Tag width (mm)	8	4	4	4	9	7
Tag width (mm)	10	4	4	4	11	9
Tag width (mm)	12	5	5	5	13	11

General notes:

The recommended applications given here do not release the user of the responsibility in individual cases from carrying out his own tests. Ensure when selecting the markers and terminals that the marker grids and terminal grids match or that the marker grid is smaller than the terminal grid.

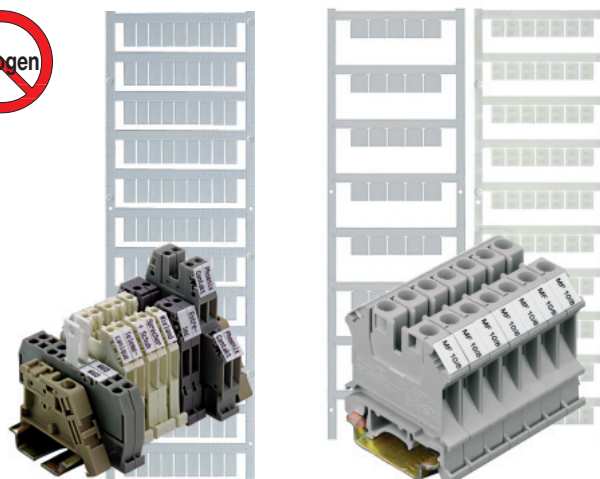

Technical data

Material	Polyamide 66 / halogen-free		
Flammability class to UL94	V2		
Temperature range °C	- 40...100		
Colour	white		
Notes on mounting	– Assemble in strips when the marker width = terminal width – Assemble individually when the marker width < terminal width		
Possible printing systems	Plotter, SMark-Laser PrintJet, MC-Mobilo		

Terminal width 4.0 mm **MultiFit**

Type	Length [mm]	Qty.	Order No.
Neutral white			
MF 5/4 MC	5.0	500	1877690000
MF-W 9/4 MC	9.0	500	1877730000
Custom print white			
MF 5/4 MC	5.0	500	1877670000
MF-W 9/4 MC	9.0	500	1877710000

Terminal width 6.0 mm **MultiFit**

Type	Length [mm]	Qty.	Order No.
Neutral white			
MF 5/6 MC	5.0	500	1816260000
MF 9/6 MC	9.0	500	1816290000
MF 10/6 MC	10.0	600	1677220000
Custom print white			
MF 5/6 MC	5.0	500	1816330000
MF 9/6 MC	9.0	500	1816360000
MF 10/6 MC	10.0	120	1677230000

Terminal width 8.0 mm **MultiFit**

Type	Length [mm]	Qty.	Order No.
Neutral white			
MF 10/8 MC	10.0	350	1868440000
Custom print white			
MF 10/8 MC	10.0	70	1868430000

Terminal width 5.0 mm **MultiFit**

Type	Length [mm]	Qty.	Order No.
Neutral white			
MF 5/5 MC	5.0	500	1816250000
MF 5/5 MC Mini	5.0	500	1816240000
MF 8/5 MC	8.0	600	1677140000
MF 9/5 MC	9.0	500	1816270000
MF 9/5F MC	9.0	500	1816280000
MF 10/5 MC	10.0	600	1677160000
MF 10/5 MC Cabur	10.0	600	1854510000
MF 12/5 MC	12.0	600	1677180000
MF 12/5 MC Cabur	12.0	600	1854520000
Custom print white			
MF 5/5 MC	5.0	500	1816320000
MF 5/5 MC Mini	5.0	500	1816310000
MF 8/5 MC	8.0	120	1677150000
MF 9/5 MC	9.0	500	1816340000
MF 9/5F MC	9.0	500	1816350000
MF 10/5 MC	10.0	120	1677170000
MF 12/5 MC	12.0	120	1677190000

Terminal width 7.5 mm **MultiFit**

Type	Length [mm]	Qty.	Order No.
Neutral white			
MF 5/7,5 MC	5.0	320	1877680000
Custom print white			
MF 5/7,5 MC	5.0	320	1877660000

Terminal width 10.0 mm **MultiFit**

Type	Length [mm]	Qty.	Order No.
Neutral white			
MF 10/10 MC	10.0	200	1856760000
Custom print white			
MF 10/10 MC	10.0	40	1856770000

Terminal markers

Snap Mark

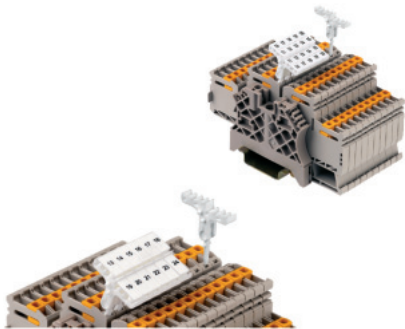

This tag rail was specially developed for the two-tier terminal IDK 1.5N available in the I-Series. The versatile hinge mechanism allows effortless mounting or removal of cross-connections. It can be equipped with four DEK 5 marking tags or two WS 10/5 Middle terminal markers.

Technical data

Tag carriers	
Material	Polyamide
Flammability class to UL94	V2
Temperature range °C	-40...100
Colour	white

Dimensions	
Length / width	23/5

Ordering data

Type	Length / Width [mm]	Qty.	Order No.
Snap Mark I	23/5	50	1805880000

BZT1 / BZT2

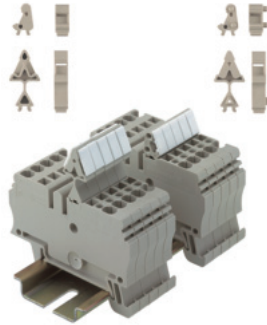

BZT marking tag rails are utilised for clear and unambiguous labelling of the ZDU 2.5/4/6 and ZDUA family of terminals. BZT marking tag rails are fitted with WS 10/5 terminal markers. By creating blocks of marking carriers, the ZA version offers maximum stability.

Technical data

Tag carriers	
Material	Polyamide
Flammability class to UL94	V2
Temperature range °C	-40...100
Colour	beige

Dimensions		Length/Width [mm]
BZT1		8/5
BZT2		12/5

Ordering data

Type	Length / Width [mm]	Qty.	Order No.
BZT 1	8/5	100	1805490000
BZT 1 ZA	8/5	100	1805520000
BZT 2	12/5	100	1805480000
BZT 2 ZA	12/5	100	1805530000

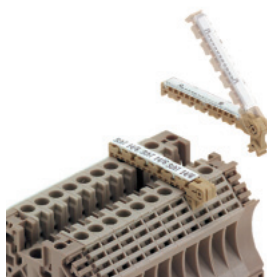
SchT 9/4 / SchT 14/6

SchT 9/4 and SchT 14/6 are hinged group marker carriers for individual Dekafix and WS tags that allow unhindered operation of the clamping screw.

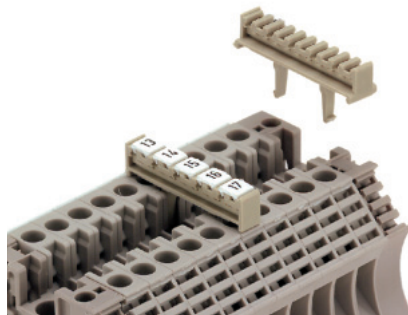
WGB 5 / WGB 8

Group marker carriers for individual Dekafix and WS tags. The WGB also cover the cross-connection channels.

Technical data

Tag carriers	
Material	Polyamide 66
Flammability class to UL94	V2
Temperature range °C	-40...100
Colour	beige

Dimensions

Length / width	44/6
----------------	------

Technical data

Tag carriers	
Material	Polyamide 66
Flammability class to UL94	V2
Temperature range °C	-40...100
Colour	beige

Dimensions

Length / width	34/5
----------------	------

Ordering data

Type	Length / Width [mm]	Qty.	Order No.
SCHT 14/6	44/6	20	1269060000
SCHT 9/4	32/4	20	1278460000

Ordering data

Type	Length / Width [mm]	Qty.	Order No.
WGB 5	34/5	50	1050760000
WGB 8	34/7.7	50	1050960000

WAGO

	MF-W 9/4	MF 5/5 mini	MF 9/5	MF 9/5 F	MF 9/6
Feed-through terminals					
264-701/704/706		X			
264-711/714/716		X			
264-721/724/726		X			
264-731/734/736		X			
264-120/125/220/225		X			
279-101/104	X				
279-604/621	X				
279-626/826	X				
279-681...686	X				
279-831...836	X				
279-901...906	X				
279-989...995	X				
280-101/104			X	X	
280-601/602			X	X	
280-603/633/634			X	X	
280-604/621/826/626			X	X	
280-641/651/654			X	X	
280-646/656/946			X	X	
280-653/671/672			X	X	
280-681/684/650			X	X	
280-830...835			X	X	
280-901...906			X	X	
280-989...995			X	X	
280-996...999			X	X	
280-691			X	X	
281-101/104					X
281-601/604					X
281-631/651					X
281-652...654					X
281-663/664/668					X
281-678/681/684					X
281-901/902/904					X
281-992...994/998/691					X
282-101/104					X
282-601/604					X
282-681/682/684/687					X
282-901/902/904/907					X
282-992/993/691					X
283-101/104					X
283-601/604/607					X
283-671/672/674/677					X
283-901/902/904/907					X
283-992/998/691					X
284-101/104					X
284-601/604/607					X
284-621/624					X
284-681/682/684/687					X
284-691/992/993					X
284-901/902/904/907					X
285-194/195					X
285-601/604/607					X
285-634/635		X			X
285-691					X
285-992/995					X
290-861/864/867			X	X	
780-992/993			X		
781-992/993					X
782-992					X
783-992					X
784-992					X
785-601/604/607/613					X
792... all	X				
812-140			X	X	X
859...all	X				
870-681/682/684	X				
870-831/832/834	X				
870-901/902/904	X				
870-911/912/914	X				
880-661/662/664	X	X			
880-681/682/684	X	X			
880-831/832/834	X	X			
880-901/902/904	X	X			
880-961/964/962	X	X			

	MF-W 9/4	MF 5/5 mini	MF 9/5	MF 9/5 F	MF 9/6
Protective earth terminals					
264-727		X			
264-737		X			
279-687	X				
279-837	X				
279-907	X				
280-107			X	X	
280-607			X	X	
280-637			X	X	
280-677			X	X	
280-687			X	X	
280-837			X	X	
280-907			X	X	
281-107					X
281-607					X
281-637					X
281-657					X
281-687					X
281-907					X
282-107					X
282-607					X
282-687					X
282-907					X
283-607					X
283-609					X
283-677					X
283-907					X
283-907					X
284-107					X
284-107					X
284-607					X
284-687					X
284-907					X
285-197					X
285-607					X
285-637		X			X
780-607			X	X	
780-637			X	X	
780-637					X
781-607					X
782-607					X
783-607					X
784-607					X
870-687		X			
870-837		X			
870-907		X			
870-917		X			
880-687		X	X		
880-837		X	X		
880-907		X	X		
Fuse terminals					
282-698					X
282-696					X
281-611/612/616/622					X
281-624/672					X
281-613/623					X
282-122					X
282-120					X
282-126					X
282-124					X
282-128					X
Two-tier terminals					
279-501/512/513	X				
279-504	X				
279-507	X				
279-508	X				
279-509	X				
279-517/527	X				
280-513			X	X	
280-517			X	X	
280-519/529			X	X	
280-520/530			X	X	
280-521/525			X	X	
280-522/526			X	X	
280-523/533			X	X	

	MF-W 9/4	MF 5/5 mini	MF 9/5	MF 9/5 F	MF 9/6
280-524/534			X	X	
280-527/537			X	X	
280-531			X	X	
280-532			X	X	
280-543			X	X	
281-619/629					X
281-620/630					X
870-101...104		X			
870-107		X			
870-108		X			
870-117/127		X			
870-501...504		X			
870-507		X			
870-508/509		X			
870-517/527		X			
870-531...534		X			
870-535/536		X			
870-537		X			
870-538/538		X			
870-826		X			
Three- and four-tier terminals					
280-549/551			X	X	
280-550			X	X	
280-552			X	X	
280-547/557/597			X	X	
280-548/558			X	X	
281-531/532		X			X
870-551/553		X			
870-556		X			
870-558/559/567/577		X			
870-557		X			
281-530					X
780-601/602/604			X	X	
780-631/651/654			X	X	
781-601/604					X
781-631/651					X
782-601/604					X
784-601/604					X
783-601/604					X
Routing and potential terminals					
727... all					X
280-675			X		
Honeycomb elements					
726... all			X		
Single terminals					
264-130/231			X		
264-131/230			X		
264-180264-280			X		
Pluggable relays and bases					
286... all		X			
786... all		X			
788... all			X	X	
789... all		X			
Multi-tier terminals					
775-641			X	X	
775-642/649			X	X	
775-646			X	X	
775-645			X	X	
777-641					X
777-642					X
777-646					X
777-645					X
777-648					X
777-647					X
777-649					X
777-651					X
777-650					X
777-652					X
776-641					X
776-645/646					X
776-649/642					X
776-650/651					X

Individual tag mounting only when terminal grid > 6 mm

	MF-W 9/4	MF 5/5 mini	MF 9/5	MF 9/5 F	MF 9/6
Disconnect test terminal					
280-612/614			X	X	
280-622/623/627			X	X	
280-649/676/685/695			X	X	
280-683			X	X	
280-805/836/829/839			X	X	
280-868/870/876/879		X	X		
280-869/871/880		X	X		
280-874/881/883/885		X	X		
280-875/882/884		X	X		
280-912...914			X		
281-659/660					X
281-666					X
281-683					X
281-912					X
282-131					X
282-133					X
282-135					X
282-138...141					X
282-694/699					X
282-811/821		X			X
282-860					X
282-865					X
282-866282-695/697					X
282-870					X
781-613/623			X	X	
781-643/653					X
782-613/623					X
783-613/623					X
784-613/623					X
Initiator terminals					
269-560		X			
269-570		X			
269-574		X			
270-560/564		X			
270-570/574		X			
270-572/577		X			
270-585/586		X			
280-553/560			X	X	
280-559			X	X	
280-561			X	X	
280-563			X	X	
280-564			X	X	
280-567			X	X	
280-570			X	X	
280-571			X	X	
280-573			X	X	
280-574			X	X	
280-577			X	X	
280-580			X	X	
280-582			X	X	
280-584			X	X	
280-584			X	X	
280-588			X	X	
Actuator terminals					
269-572		X			
269-585		X			
280-515			X	X	
280-554			X	X	
280-555			X	X	
280-556			X	X	
280-562			X	X	
280-565			X	X	
280-566			X	X	
280-568			X	X	
280-572			X	X	
280-575			X	X	
280-576			X	X	
280-578			X	X	
280-583			X	X	
280-585			X	X	
280-586			X	X	
280-592			X	X	
280-593			X	X	

	MF-W 9/4	MF 5/5 mini	MF 9/5	MF 9/5 F	MF 9/6	
Diode and LED terminals						
279-620	X					
279-623	X					
279-624	X					
279-673	X					
279-674	X					
279-809	X					
279-815	X					
279-915	X					
280-613			X	X		
280-615			X	X		
280-623			X	X		
280-624			X	X		
280-655			X	X		
280-658			X	X		
280-673			X	X		
280-809			X	X		
280-815			X	X		
280-915			X	X		
280-940			X	X		
280-941			X	X		
280-942			X	X		
280-943			X	X		
281-603					X	
281-633					X	
281-634					X	
281-635					X	
281-636					X	
281-665					X	
281-673					X	
281-915					X	
870-540		X				
870-541		X				
870-542		X				
870-543		X				
870-590		X				
870-593		X				
870-596		X				
X-Com system						
769... all		X				
I/O modules TOPLON						
750... all		X			X	
Siemens						
	MF-SI 8/5	MF-SI 10/5	MF-SI 8/6	MF-SI 10/6	MF-SI 8/6-5	MF-SI 10/6-5
8WA1 011-0DG...					X	X
8WA1 011-1BG...					X	X
8WA1 011-1DG...					X	X
8WA1 011-1NG...					X	X
8WA1 011-1PG...					X	X
8WA1 011-6EG...					X	X
8WA2 011-1BF...	X	X				
8WA2 011-1BG...			X	X		
8WA2 011-1DF...	X	X				
8WA2 011-1DG...			X	X		
8WA2 011-1EF20	X	X				
8WA2 011-1LF20	X	X				
8WA2 011-1NG23			X	X		
8WA2 011-1PF...	X	X				
8WA2 011-1PG...			X	X		
8WA2 011-2BG...			X	X		
8WA2 011-2DG...			X	X		
8WA2 011-3JG...			X	X		
8WA2 011-6EG...			X	X		

	MF 5/7,5	MF 5/5 mini	ESG 8/11	GWS 5/5	GWS 9/5	GWS 12/5	GWS 9/6	GWS 12/6
Adels								
RKV- transformer terminal	X							
Beckhoff								
I/O modules	X	X						
Woertz								
2711/60	X							
30041								X
30128								X
30143								X
30168								X
30172								X
30176								X
30191								X
30195								X
30228								X
30432							X	
30810			X					
30870						X		
30880						X		
30903			X					
33100								X
30005...9								X
30123...130								X
30137...8								X
30145...								X
30150...			X					
30197/200								X
30290...1								X
30400...405		X						
30430...							X	
30431...							X	
30544...								X
30800...								X
30840...44								X
30860...			X					
30890...1						X		
30902...						X		
30930...								X
30950...2						X		
3410...						X		
3424...9								X
3430...						X		
3436...8								X
3440...								X
3450...								X
3452...								X
3472/73/77								X
35310/3...50/3			X	X				
35310/4...90/4						X	X	
35370/2...			X					

Individual tag mounting only when terminal grid > 6 mm

Entrelec

	MF 5/5 mini	MF 10/5	MF 10/6	MF 10/8	MF 10/10
41 H LT...	X				
62 H...	X				
D 1,5/6...	X				
D 2,5/5...	X				
D 2,5/6...	X				
D 2,5/8...	X				
D 4/6...	X				
D 4/6...	X		X		
D 4/8...	X				
DB 1,5/6...	X				
DB 2,5/8...	X				
DB 4/6...	X				
DB 4/8...	X				
DH 1,5/6...	X				
DH 2,5/8...	X				
DH 4/6...	X				
DH 4/8...	X				
DL 10/17,5...	X				
DR 1,5/5...	X				
DR 1,5/6...	X				
DR 2,5/10...	X				
DR 2,5/5...	X				
DR 2,5/8...	X				
DR 4/6...	X				
DR 4/8...	X				
DS 1,5/6...	X				
DS 2,5/8...	X				
DS 4/6...	X				
DS 4/8...	X				
H 1/10...	X				
HD 2,5/6...	X				
HD 6/14...	X				
HD 6/8...	X				
HD 6/9...		X			
M 10/10...					X
M 10/16...			X	X	X
M 10/22...			X	X	X
M 16/12...			X	X	X
M 35/16...			X	X	X
M 4/6...			X		
M 4/7...			X		
M 4/8...				X	
M 4/9...			X	X	
M 6/8...				X	
M 70/22...			X	X	X
M 95/26...			X	X	X
MA 2,5/5...		X			
MB 10/10...					X
MB 10/13...			X	X	X
MB 10/14,5...			X	X	X
MB 10/24...			X	X	X
MB 25/30...			X	X	X
MB 4/6...			X		
MB 6/8...				X	
MB 70/10...					X
MS 6/8...				X	
MS4/6...			X		
MTC 6			X		
T 1,5/5...	X				
T 2,5/5...	X				
T 2,5/6...	X				
T 4/6...	X				

Wieland

	MF-W 9/4	MF 5/5 mini	MF 9/5	MF 9/5 F	MF 9/6
9700 A/5...	X				
9700 B...				X	
9701 A/6...A/16				X	
9760 U...				X	
9785 U...				X	
9786 U...				X	
AKB...	X	X	X		
AKT...	X	X	X		
Terminal Adapter...	X	X	X		
UET...	X	X	X		
WEB...	X	X	X		
WEG...	X	X	X		
WK / WKN 10...				X	
WK / WKN 16...150				X	
WK / WKN 2,5...	X	X	X		
WK / WKN 4...				X	
WK / WKNn 6...				X	
WK/3-6...				X	
WK/4-8...				X	
WKB 2,5...	X	X	X		
WKF 1,5...	X	X	X		
WKF 10...				X	
WKF 16...				X	
WKF 2,5...	X	X	X		
WKF 4...				X	
WKF 6...				X	
WKI 10...35				X	
WKI 4...				X	
WKM 2,5...	X	X	X		
WKM 4...					

Cabur

	MF 10/5 Cabur	MF 12/5 Cabur
CBD.2...70	X	X
TLS.2...	X	X
TLD.2...	X	X
CBR.2...	X	X
DCS.4...	X	X
DAS.4...	X	X
SPO.4...	X	X
SCB.4...6	X	X
VLO.4...	X	X
SDO.4...	X	X
SRO.4...	X	X
SZO.4...	X	X
SFR.4...	X	X
SFO.4...	X	X
FPC.10...	X	X
FPL.10...	X	X
TC/PO...	X	X
MPS.2...	X	X
AFO.2...	X	X
PDF.2...	X	X
FDP.2...	X	X
VPC.2...	X	X
CVF.4...	X	X
FFS.4...	X	X
FVS.4...	X	X
MAC.6...	X	X
CAM...	X	X
RN.1...	X	
RFI.2...	X	
RN.4...	X	
RP.4...	X	
TR.4...	X	X
TE.4...35	X	X
CBE.2...	X	

Wire and cable markers

Weidmüller's range of wire and cable markers provides users with solutions for a wide variety of applications. The applications range from thin wires through to cables with large external diameters. Amongst others, the assortment includes combination systems with individual tags, transparent sleeves and markers that are fastened using cable ties.

Open and closed, printed or neutral markers for individual printing are available.

Systems are available for:

- Clip-on ready-to-use printed markers according to individual marking requirements
- Marking by digits from a standard set of characters
- Combination of individual pre-printed digits to form a character code
- Customer prints utilising one of the following options: SMark-Laser printer, PrintJet printer, laser printer, plotter, thermal transfer, Matrix printer or pen.

Halogen-free and practically free of pollutants, Weidmüller's wire and cable markers comply with both European and in-house standards of well-known system manufacturers.

A sample selection is available in Weidmüller's sample bag of wire and cable markers: order no. **1640420000**.

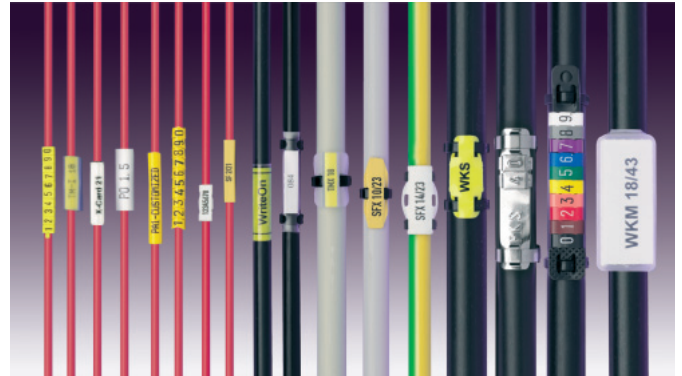

Matrix wire and cable markers

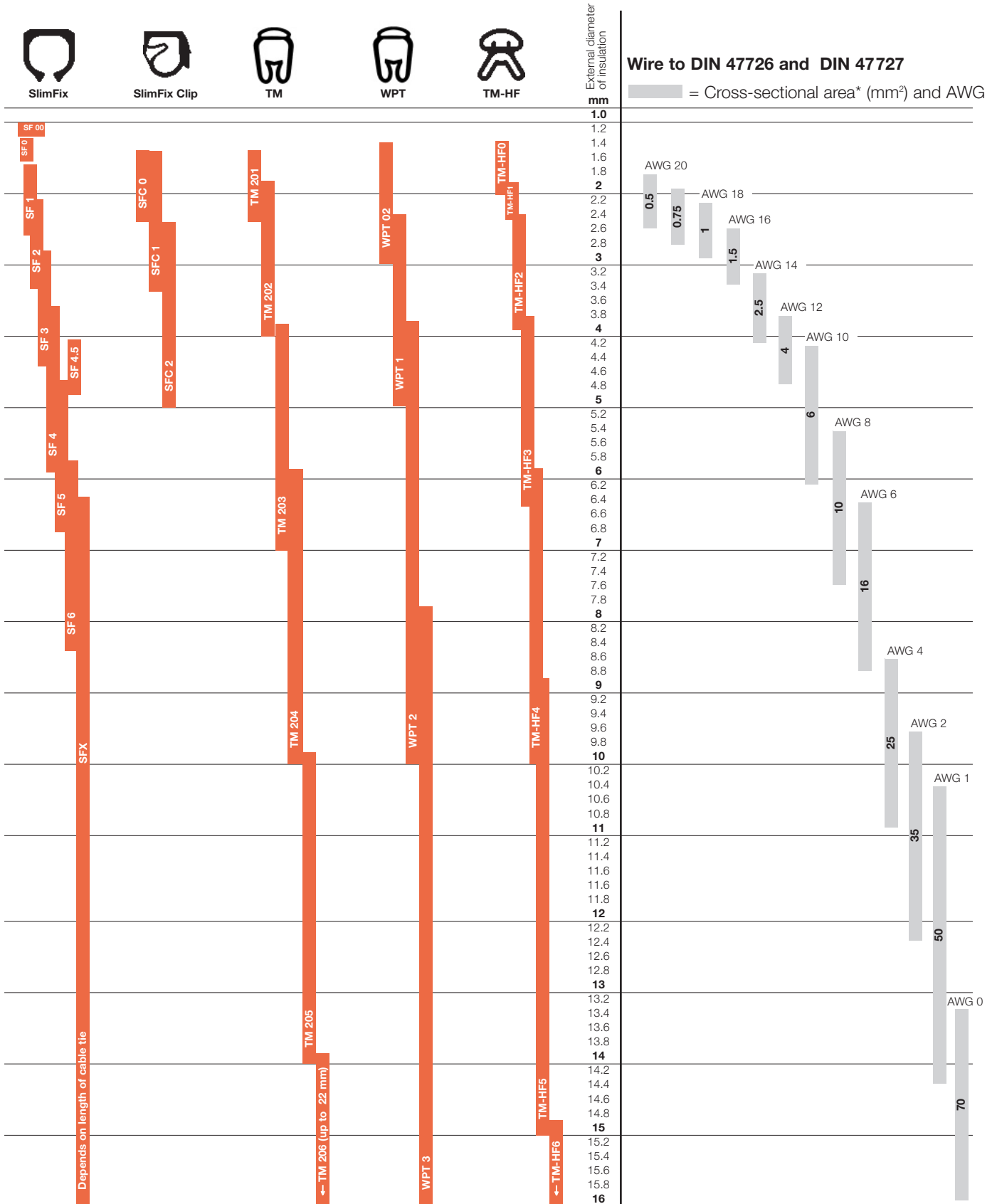

* Non-binding reference values. Please take into consideration the external diameter of the insulation.

Wire and cable markers

SlimFix

SlimFix are wire and cable markers featuring a space-saving design. The markers can also be attached to the wires after these have been installed. They are made from halogen-free material and fulfil flammability class VO requirements. SlimFix is an approved and listed marker for traffic engineering. Attaching even small markers is no problem when using the SF tool.

- Halogen-free material
- Flammability class VO/V2
- Approved and listed markers, includes traffic engineering
- Attach to conductor cross-sections greater than 16.0 mm² with cable ties
- Markers available in the proven MultiCard format

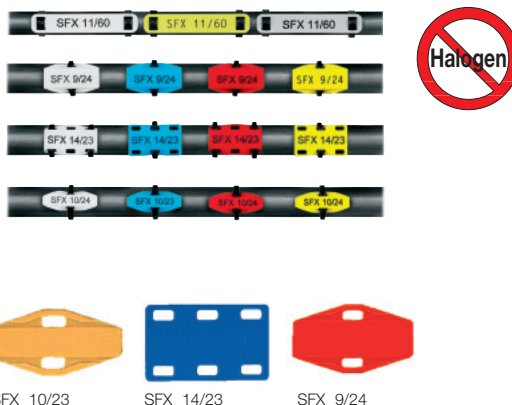

Technical data

SF/SFX	
Material	Wemid / Polyamide
Flammability class to UL94	VO/V2
Temperature range	V0: -50 °C... 120 °C/V2: -40 °C... 100 °C
Possible printing systems	Plotter, SMark-Laser, PrintJet, MC-Mobilo
Colour	white, yellow, blue, red, green (grey)
Notes on mounting	SF: Slide onto unconnected wires; attach to connected wires using SlimFix tool SFX: Attach using cable ties

Selection table

Type	Cond. ext. Ø. (max.) mm	Cond. cross-section mm ²
SF 00	1.0...1.3	< 0.25
SF 0	1.3...1.6	0.25...0.5
SF 1	1.6...2.1 (2.7)	0.5...0.75
SF 2	2.1...2.9 (3.4)	0.75...1.5
SF 3	2.9...3.6 (4.5)	1.5...2.5
SF 4	3.6... 4.5 (6.0)	2.5...4.0
SF 4,5	4.1...4.9	4.0...6.0
SF 5	4.7...5.8 (6.8)	6.0...10.0
SF 6	5.8...7.0 (8.5)	10.0...16.0
SFX	from 7.0	from 16.0
SFX only: max. width of cable tie = 3.6 mm		

Ordering information

Minimum order quantity	1 Qty.
For custom print, provide details of colour and print.	

Number of characters when using plotter font

Pin size	0.18	0.25	0.35	0.18	0.25	0.35
Font size (pt)	10	10	10	4	5	6
Tag width (mm) 12	5	5	5	13	11	9
Tag width (mm) 21	10	10	10	24	19	16

Printing system

The IP-220 standard plotter (**1674820000**) and the MultiCard support frame (**1610040000**) can be used for printing the sizes SF00, SF0, SF 1, SF 2, SF 3 and SFX. The plotter IP-22 special (**1674810000**) and the specified support frames are required to be able to print the complete assortment of SlimFix markers.

Ordering data

SFX neutral

	Qty.	Order No.				
23.0 mm		white	yellow	blue	red	grey
SFX 10/23 V0	160	1727750001	1727750004	1727750002	1727750003	
SFX 10/23 V2	160	1852390000	1852360000	1852400000	1852370000	
SFX 14/23 V0	160	1713660001	1713660004	1713660002	1713660003	
SFX 14/23 V2	160	1852440000	1852410000	1852450000	1852420000	
24.0 mm		white	yellow	blue	red	grey
SFX 9/24 V0	160	1696140001	1696140004	1696140002	1696140003	
SFX 9/24 V2	160	1852490000	1852460000	1852500000	1852470000	
60.0 mm						
SFX 11/60	60	1860120000	1860150000			1860130000

Ordering data

SFX custom print

Ordering data

SlimFix Tool

	Qty.	Order No.		Qty.	Order No.
23.0 mm					
SFX 10/23 V0	32	1727760000	SF-Tool 1	10	1782970000
SFX 10/23 V2	32	1852380000	SF-Tool 2-3	10	1782960000
SFX 14/23 V0	32	1713670000	SF-Tool 4-5	10	1782980000
SFX 14/23 V2	32	1852430000	SF tool assortment	1	1770080000
24.0 mm					
SFX 9/24 V0	32	1689500000			
SFX 9/24 V2	32	1852480000			
60.0 mm					
SFX 11/60	12	1860140000			

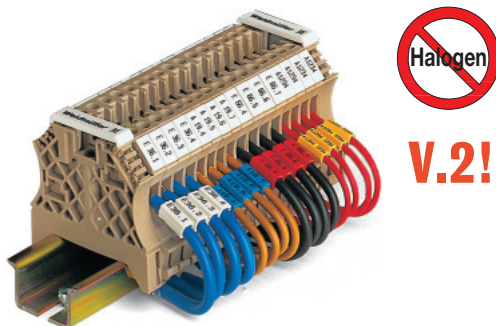

Technical data

Material	Polyamide
Flammability class to UL94	V2
Temperature range °C	-40...100

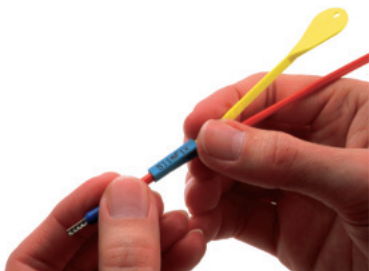

SlimFix Neutral

	Max. ext. diameter of wire [mm]	Max. cond. cross-section [mm²]	Qty.	Order No.			
				white	yellow	blue	red
Length: 12 mm							
SF 00/12	1.0...1.3	...0.25	400	1740830001	1740830004	1740830002	1740830003
SF 0/12	1.3...1.6	0.25...0.5	400	1724050001	1724050004	1724050002	1724050003
SF 1/12	1.6...2.1	0.50...0.75	400	1711320001	1711320004	1711320002	1711320003
SF 2/12	2.1...2.9	0.75...1.5	400	1711350001	1711350004	1711350002	1711350003
SF 3/12	2.9...3.6	1.50...2.5	320	1711370001	1711370004	1711370002	1711370003
SF 4/12	3.6...4.5	2.50...4	128	1743490001	1743490004	1743490002	1743490003
SF 5/12	4.7...5.8	4.00...6	160	1743500001	1743500004	1743500002	1743500003
Length: 21 mm							
SF 00/21	1.0...1.3	...0.25	400	1740840001	1740840004	1740840002	1740840003
SF 0/21	1.3...1.6	0.25...0.5	400	1740850001	1740850004	1740850002	1740850003
SF 1/21	1.6...2.1	0.50...0.75	400	1696090001	1696090004	1696090002	1696090003
SF 2/21	2.1...2.9	0.75...1.5	400	1696100001	1696100004	1696100002	1696100003
SF 3/21	2.9...3.6	1.50...2.5	320	1696110001	1696110004	1696110002	1696110003
SF 4/21	3.6...4.5	2.50...4	192	1696120001	1696120004	1696120002	1696120003
SF 4,5/21	4.1...4.9	4.00...6	96	1740860001	1740860004	1740860002	1740860003
SF 5/21	4.7...5.8	6.00...10	160	1696130001	1696130004	1696130002	1696130003
SF 6/21	5.8...7.0	10.00...16	160	1740870001	1740870004	1740870002	1740870003

SlimFix custom print

	Max. ext. diameter of wire [mm]	Max. cond. cross-section [mm²]	Qty.	Order No.
Length: 12 mm				
SF 00/12	1.0...1.3	...0.25	80	1740880000
SF 0/12	1.3...1.6	0.25...0.5	80	1724060000
SF 1/12	1.6...2.1	0.50...0.75	80	1711330000
SF 2/12	2.1...2.9	0.75...1.5	80	1711360000
SF 3/12	2.9...3.6	1.50...2.5	64	1711380000
SF 4/12	3.6...4.5	2.50...4	32	1748920000
SF 5/12	4.7...5.8	4.00...6	32	1748930000
Length: 21 mm				
SF 00/21	1.0...1.3	...0.25	80	1740890000
SF 0/21	1.3...1.6	0.25...0.5	80	1740900000
SF 1/21	1.6...2.1	0.50...0.75	80	1689400000
SF 2/21	2.1...2.9	0.75...1.5	80	1689420000
SF 3/21	2.9...3.6	1.50...2.5	64	1689440000
SF 4/21	3.6...4.5	2.50...4	48	1689460000
SF 4,5/21	4.1...4.9	4.00...6	32	1740910000
SF 5/21	4.7...5.8	6.00...10	32	1689480000
SF 6/21	5.8...7.0	10.00...16	32	1740920000

SlimFix

SlimFix are wire and cable markers featuring a space-saving design. The markers can also be attached to the wires after these have been installed. They are made from halogen-free material and fulfil flammability class VO requirements. SlimFix is an approved and listed marker for traffic engineering. Attaching even small markers is no problem when using the SF tool.

- Halogen-free material
- Flammability class V0/V2
- Approved and listed markers, includes traffic engineering
- Attach to wire cross-sections above 16.0 mm² with cable ties
- Markers available in the proven MultiCard format



Technical data

Material	Polyamide 6.6
Flammability class to UL94	VO
Temperature range °C	-50...120 °C

SlimFix Neutral

Length: 12 mm	Qty.	Order No.			
		white	yellow	blue	red
VT SF 00/12	800	1752200001	1752200004	1752200002	1752200003
VT SF 0/12	800	1752110001	1752110004	1752110002	1752110003
VT SF 1/12	800	1718470001	1718470004	1718470002	1718470003
VT SF 2/12	800	1718480001	1718480004	1718480002	1718480003
VT SF 3/12	640	1718490001	1718490004	1718490002	1718490003
VT SF 4/12	192	1746030001	1746030004	1746030002	1746030003
VT SF 5/12	160	1746040001	1746040004	1746040002	1746040003
Length: 21 mm	Qty.	Order No.			
		white	yellow	blue	red
VT-SF 00/21	800	1730580001	1730580004	1730580002	1730580003
VT-SF 0/21	800	1730590001	1730590004	1730590002	1730590003
VT SF 1/21	800	1689390001	1689390004	1689390002	1689390003
VT SF 2/21	800	1689410001	1689410004	1689410002	1689410003
VT SF 3/21	512	1689430001	1689430004	1689430002	1689430003
VT SF 4/21	288	1689450001	1689450004	1689450002	1689450003
VT-SF 4.5/21	192	1730570001	1730570004	1730570002	1730570003
VT SF 5/21	160	1689470001	1689470004	1689470002	1689470003
VT-SF 6/21	160	1730560001	1730560004	1730560002	1730560003

SlimFix custom print

	Qty.	Order No.
VT-SF 0/21	80	1888850000
VT-SF 1/21	80	1789230000
VT-SF 2/21	80	1789240000
VT-SF 3/21	64	1789250000
VT-SF 4/21	48	1789260000
VT-SF 4.5/21	32	1789270000
VT-SF 5/21	32	1789280000
VT-SF 6/21	32	1789290000

Wire and cable markers

SlimFix Clip

The SlimFix Clip combines two advantages in one: its unique closure mechanism offers the reliability of a closed marker with ease of attaching an open marker. The Clip closure mechanism also allows quick, no fuss attachment of the markers after the wires have been installed. SlimFix Clip markers are suitable for wires and cables with external diameters up to 5 mm. Long sequences of characters are possible on the large marking surface – up to 30 mm.

- Halogen free, flammability class V2 material
- Narrow markers with reliable attachment thanks to compensation feature
- Clip closure mechanism ensures permanent attachment following wire installation
- Rapid attachment without tools
- Three sizes for wire cross-sections from 0.5 – 4.0 mm²
- Available in lengths of 12, 21 and 30 mm
- Markers available in the proven MultiCard format
- Additional marking surface for precise assignment to projects
- Custom-printed markers supplied to your specifications

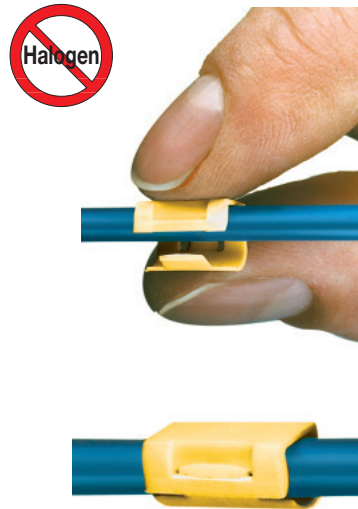

Selection table

Type	Wire, ext. ϕ	Wire cross-section
SFC 0	1.5 – 2.5 mm	0.5 – 1.0 mm ²
SFC 1	2.0 – 3.5 mm	0.75 – 2.5 mm ²
SFC 2	2.5 – 5.0 mm	2.5 – 4.0 mm ²

Ordering information

Minimum order quantity	1 Qty.
------------------------	--------

Number of characters when using plotter font

Pin size	0.18	0.25	0.35	0.18	0.25	0.35
Typeface (pt)	10	10	10	4	5	6
Tag width (mm) 12	5	5	5	13	11	9
Tag width (mm) 21	10	10	10	24	19	16

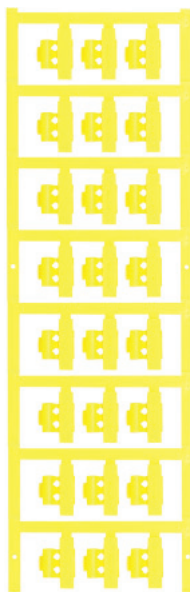
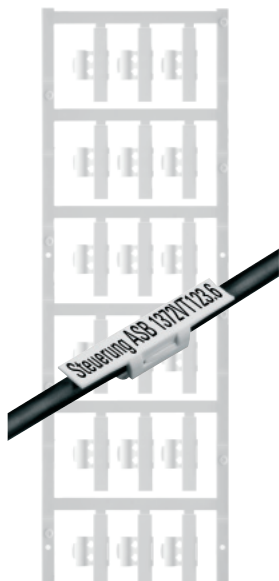

Technical data

Material	Polyamide 66
Flammability class to UL94	V2
Temperature range °C	-40...100
Dimensions	12 mm, 21 mm and 30 mm lengths
	SFC 1/12, for example, size 1, length 12 mm
Colour	white, yellow, blue, red
Possible printing systems	SMark-Laser, PrintJet; please refer to printer systems
Notes on mounting	Attach to unconnected and connected wires

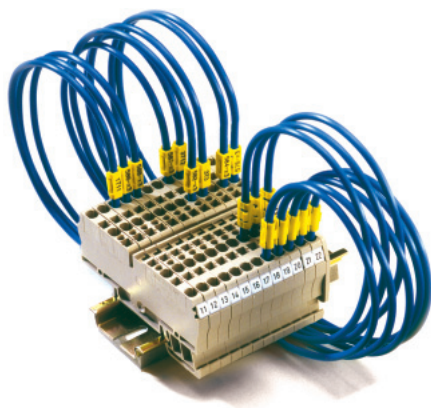

SFC Neutral

	Max. ext. diameter of wire [mm]	Max. cond. cross-section [mm ²]	Qty.	Order No.			
Length: 12.0 mm							
SFC 0/12	1.5...2.5	0.5...1.0	200	white	yellow	blue	red
SFC 1/12	2...3.5	0.75...2.5	200	1747320001	1747320004	1747320002	1747320003
SFC 2/12	2.5...5.0	2.5...4.0	120	1758320001	1758320004	1758320002	1758320003
Length: 21.0 mm							
SFC 0/21	1.5...2.5	0.5...1.0	200	white	yellow	blue	red
SFC 1/21	2...3.5	0.75...2.5	200	1813190000	1813210000	1813220000	1813200000
SFC 2/21	2.5...5.0	2.5...4.0	120	1779080001	1779080004	1779080002	1779080003
SFC 2/21	2.5...5.0	2.5...4.0	120	1805810000	1805780000	1805770000	1805790000
Length: 30.0 mm							
SFC 0/30	1.5...2.5	0.5...1.0	150	white	yellow	blue	red
SFC 1/30	2...3.5	0.75...2.5	150	1813240000	1813260000	1813270000	1813250000
SFC 2/30	2.5...5.0	2.5...4.0	90	1805760000	1805730000	1805720000	1805740000
SFC 2/30	2.5...5.0	2.5...4.0	90	1805870000	1805830000	1805820000	1805850000

SFC custom print

	Max. ext. diameter of wire [mm]	Max. cond. cross-section [mm ²]	Qty.	Order No.
Length: 12.0 mm				
SFC 0/12	1.5...2.5	0.5...1.0	40	1813180000
SFC 1/12	2...3.5	0.75...2.5	40	1752720000
SFC 2/12	2.5...5.0	2.5...4.0	24	1763480000
Length: 21.0 mm				
SFC 0/21	1.5...2.5	0.5...1.0	40	1813230000
SFC 1/21	2...3.5	0.75...2.5	40	1779090000
SFC 2/21	2.5...5.0	2.5...4.0	24	1805800000
Length: 30.0 mm				
SFC 0/30	1.5...2.5	0.5...1.0	30	1813280000
SFC 1/30	2...3.5	0.75...2.5	30	1805750000
SFC 2/30	2.5...5.0	2.5...4.0	18	1805860000

TM sleeve

Transparent sleeves



The extensive assortment of TM sleeves is suitable for universal use:

It covers a wide range of applications from narrow wires through to cables with large external diameters.

The assortment offers unrivalled protection for printed insert tags against external influences.

Available in five different lengths and nine sizes, TM sleeves are easy to attach

- A tag type for all sleeves
- Optimum protection of printed insert tags
- Wide range of applications for wires and cables
- A tag type for all cross-sections

Technical data

Material	PVC
Flammability class to UL 94	V 0
Temperature range	-50 ... +80 °C
Dimensions	Lengths 12 mm, 15 mm, 18 mm, 20 mm, 30 mm
Colour	Transparent
Possible marking systems	Insert tag TM-I, or PF
Minimum order quantity	1 Qty.

Ordering information

TM

Type	Insulation, ext. Ø	Cond. cross-sec.
TM 201	1.5 – 2.5 mm	0.25 – 1.5 mm ²
TM 202	2.0 – 4.0 mm	0.5 – 2.5 mm ²
TM 203	4.0 – 7.0 mm	2.5 – 10.0 mm ²
TM 204	6.0 – 10.0 mm	6.0 – 16.0 mm ²
TM 205	10.0 – 14.0 mm	16.0 – 35.0 mm ²
TM 206	14.0 – 22.0 mm	35.0 – 120.0 mm ²
TM 207	22.0 – 30.0 mm	120.0 – 240.0 mm ²
TM 208	30.0 – 35.0 mm	240.0 – 300.0 mm ²
TM 209	35.0 – 40.0 mm	300.0 – 500.0 mm ²

This data is provided as a guideline. It refers exclusively to the diameter of the cable. Differing insulation materials can deviate considerably from the above values.

Ordering data

TM

Type	Qty.	Order No.
TM 201/12	1000	1798640000
TM 202/12	1000	1798560000
TM 203/12	500	1798510000
TM 204/12	500	1806180000
TM 205/12	200	1806190000
TM 206/12	200	1806200000
TM 207/12	50	1806210000
TM 208/12	50	1806220000
TM 209/12	50	1806230000
TM 201/15	1000	1798620000
TM 202/15	1000	1798540000
TM 203/15	500	1798490000
TM 204/15	500	1806240000
TM 205/15	200	1806250000
TM 206/15	200	1806260000
TM 207/15	50	1806270000
TM 208/15	50	1806280000
TM 209/15	50	1806290000
TM 201/18	1000	1798600000
TM 202/18	1000	1798530000
TM 203/18	500	1798480000
TM 204/18	500	1806300000
TM 205/18	200	1806310000
TM 206/18	200	1806320000
TM 207/18	50	1806330000
TM 208/18	50	1806340000
TM 209/18	50	1806350000

Ordering data

TM

Type	Qty.	Order No.
TM 201/20	1000	1798580000
TM 202/20	1000	1798520000
TM 203/20	500	1798470000
TM 204/20	500	1806360000
TM 205/20	200	1806370000
TM 206/20	200	1806380000
TM 207/20	50	1806390000
TM 208/20	50	1806400000
TM 209/20	50	1806410000
TM 201/30	500	1874850000
TM 202/30	500	1874760000
TM 203/30	200	1874770000
TM 204/30	200	1874780000
TM 205/30	200	1874790000
TM 206/30	100	1874800000
TM 207/30	50	1874820000
TM 208/30	50	1874830000
TM 209/30	50	1874720000

TM-HF sleeve

Transparent sleeves



TM sleeves are halogen free and practically free from pollutants. The sleeves can be fitted with insert tags TM-I 12 or TM-I 18. They offer a wide range of applications for cables and wires. This system has proven particularly successful in traffic engineering. The slim design guarantees a secure attachment to the wire.

- Halogen-free
- Slim design guarantees secure attachment to the wire.

Technical data

Material	Polyethylene PE-LD
Flammability class to UL 94	HB
Temperature range	-20 ... + 80 °C
Dimensions	Length: 12 mm and 18 mm
Colour	Transparent
Possible marking systems	Insert tag TM-I 12 and 18
Minimum order quantity	1 Qty.

Ordering data

Type	Qty.	Order No.
TM 0/12 HF	1000	1719760000
TM 1/12 HF	1000	1719780000
TM 2/12 HF	1000	1719800000
TM 3/12 HF	500	1719820000
TM 4/12 HF	500	1719840000
TM 5/12 HF	200	1719860000
TM 6/12 HF	200	1719880000
TM 0/18 HF	1000	1719770000
TM 1/18 HF	1000	1719790000
TM 2/18 HF	1000	1719810000
TM 3/18 HF	500	1719830000
TM 4/18 HF	500	1719850000
TM 5/18 HF	200	1719870000
TM 6/18 HF	200	1719890000

TMX-HF sleeve

Transparent sleeves



TMX rounds Weidmüller's extensive assortment of sleeves. By utilising cable ties, the transparent, halogen-free TMX sleeves can be fitted to any size of wire. The TMX sleeve is fitted with the insert tag TM-I 18. It is designed for a wide range of applications. The TMX sleeves are suitable for cables and wires with an external diameter from 15 mm and upwards. Cable ties guarantee secure attachment.

- Halogen-free
- Secure attachment with cable ties

Technical data

Material	Polyethylene PE-LD
Flammability class to UL 94	HB
Temperature range	-20 ... + 80 °C
Dimensions	Length: 18 mm
Colour	Transparent
Possible marking systems	Insert tag TM-I 18
Please refer to page 46 for CB cable ties	
Max. width of cable tie	4.8 mm
Minimum order quantity	1 Qty.

Ordering information

Type	Insulation, ext. Ø	Cond. cross-sec.
TM-HF 0	1.3 – 2.0 mm	0.22 – 0.5 mm ²
TM-HF 1	1.8 – 2.5 mm	0.5 – 1.5 mm ²
TM-HF 2	2.5 – 4.0 mm	0.75 – 2.5 mm ²
TM-HF 3	4.0 – 6.5 mm	2.5 – 6.0 mm ²
TM-HF 4	6.0 – 10.0 mm	10.0 – 35 mm ²
TM-HF 5	9.0 – 15.0 mm	25.0 – 70 mm ²
TM-HF 6	15.0 – 24.0 mm	35.0 – 150 mm ²

Ordering information

Type	Insulation, ext. Ø	Cond. cross-sec.
TMX	15.0 mm	25 mm ²

Ordering data

Type	Qty.	Order No.
TMX	500	1748820000

Twin sleeve

Transparent sleeves

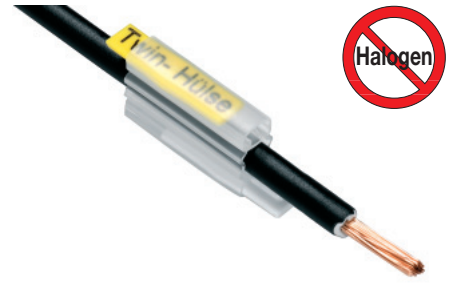

Twin sleeves provide a two-side marking option of wires. They can be fitted with two TM-I 18 tags, so that input and output designations of a wire can be viewed from a single vantage point. The transparent, halogen-free sleeves can be used for external wire-insulation diameters from 1.3 to 4.0 mm.

Technical data

Material	Polyethylene PE-LD
Flammability class to UL 94	HB
Temperature range	-20 ... + 80 °C
Dimensions	Length: 18 mm
Colour	Transparent
Possible marking systems	Insert tag TM-I 18
Minimum order quantity	1 Qty.

Ordering information

Type	Insulation, ext. Ø	Cond. cross-sec.
TM 0/18 Twin HF/HB	1.3 – 2.6 mm	0.22 – 1.5 mm ²
TM 1/18 Twin HF/HB	2.4 – 4.0 mm	1.0 – 2.5 mm ²

Ordering data

Type	Qty.	Order No.
TM 0/18 Twin HF/HB	500	1891810000
TM 1/18 Twin HF/HB	500	1891780000

WPT sleeve

Transparent sleeves



WPT wire and cable markers are high-quality, transparent markers available in various lengths for marking cables with cross-sections from 0.22 mm² to maximum 75 mm².

- Wider cross-section range per sleeve
- Wider application range thanks to special resilient bellow profile
- Marker tag inserts easily into marker pocket before and after wire is connected
- Available in five lengths and four sizes

Technical data

Material	Soft PVC, cadmium- and silicone-free
Temperature range	-30 °C to +80 °C
Flammability class.	Flame resistant and self-extinguishing, V0 to UL94
Resistance	Highly resistant to oils and petrol as well as gamma and UV radiation
Print	Insert tag TM-I for WPT and WPM 10-33

Ordering information

Type	Insulation, ext. Ø	Cond. cross-sec.
WPT 02	1.3 – 3.0 mm	0.22 – 1.5 mm ²
WPT 1	2.5 – 5.0 mm	0.75 – 6.0 mm ²
WPT 2	4.0 – 10.0 mm	4.0 – 35.0 mm ²
WPT 3	8.0 – 16.0 mm	6.0 – 75.0 mm ²

Ordering data

Type	Length / Width [mm]	Qty.	Order No.
WPT 02-12		200	1764060000
WPT 02-15		200	1764070000
WPT 02-18		200	1764140000
WPT 02-20		200	1764150000
WPT 02-30		200	1889580000
WPT 1-12		200	1764190000
WPT 1-15		200	1764200000
WPT 1-18		200	1764210000
WPT 1-20		200	1764220000
WPT 1-30		200	1889560000
WPT 2-12		100	1764230000
WPT 2-15		100	1764240000
WPT 2-18		100	1764250000
WPT 2-20		100	1764260000
WPT 2-30		100	1889570000
WPT 3-12		100	1764270000
WPT 3-15		100	1764280000
WPT 3-18		100	1764290000
WPT 3-20		100	1764300000
WPT 3-30		100	1889550000

WPM sleeve

Transparent sleeves



WPM is the right sleeve for larger wire cross-sections. The transparent sleeve pocket protects the insert tags against environmental conditions. The transparent WPM sleeves are securely attached using cable ties. TM-I 18 for WPM 10/33 or ESG 9/17 for WPM 20/33 provide the markings. Both insert tags have been designed in the proven Multicard format for convenient printing with SMark-Laser, PrintJet, Plotter or MC-Mobilo. The tag PF 2/17.5 is suitable for the WPM 20/66.

- Secure attachment with cable ties
- Professional printing assured thanks to Weidmüller's printing system for MultiCards

Technical data

Material	PVC
Flammability class to UL 94	V0
Temperature range	-30 ... +60 °C
WPM 20 dimensions	Length: 33 mm and 66 mm Width: 11.3 mm
WPM 10 dimensions	Length: 33 mm Width: 6 mm
Colour	transparent
Possible marking systems	Insert tags TM-I 18 ESG 9/17 or PF2/17,5

Ordering data

Type	Qty.	Order No.
WPM 10/33	100	1763270000
WPM 20/33	100	1763280000
WPM 20/66	50	1763390000
Accessories		
ESG 9/17 neutral	200	1724760000
ESG 9/17 printed	200	1770480000
WPF 2/17.5	DIN A 4 sheets = 352 Labels	1764050000

WKM sleeve

Transparent sleeves

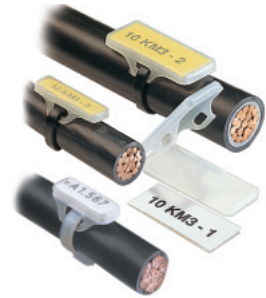

Providing secure attachment to the wire or cable, WKM is the right marker for tough conditions. The transparent sleeve pocket guarantees reliable protection of the marking in tough environmental conditions. Cable tie attachment facilitates their use with practically all wire cross-sections. WKM provides numerous markings options, for example, laser print, matrix print or STI marking pen on paper or polyester labels.

Technical data

Tag carriers	
Material	Polypropylene
Flammability class to UL94	IP40
Temperature range °C	-40...80
Colour	transparent

Ordering data

Type	Length / Width [mm]	Qty.	Order No.
WKM 18/43	43/18	50	1610700000
WKM 8/20	20/8	50	1753490000
WKM 8/30	30/8	50	1631910000

Accessories

Type	Length / Width [mm]	Qty.	Order No.
ESG 7/20 white	7/20	200	1736181044
ESO 5 white	40/16.5	1	1607710000
ESO 5 yellow	40/16.5	1	1631350000
ESO 5P white	40/16.5	10	1670370000
ESO 5P yellow	40/16.5	10	1670380000
ESO 7 white	27/6.3	1	1607720000
ESO 7 yellow	27/6.3	1	1634780000
ESO 7P white	27/6.3	10	1670390000
ESO 7P yellow	27/6.3	10	1670400000

ESO 5/5P: 16.5 x 40 mm, 60 tags per sheet
ESO 7/7P: 6.3 x 27 mm, 240 tags per sheet

WPF sleeve

Insert tags



WPF insert tags are made from a halogen-free polyester material. The perforated edges ensure the tags can easily be separated from the A4 sheets in which they are supplied. The pre-print treated material guarantees rapid and permanent marking by means of laser, matrix or plotter print.

Technical data

Material	polyester foil, halogen-free
Temperature range	-30 to + 120 °C
Dimensions	
WPF 1/21	21 mm
WPF 2/17,5	17.5 mm
Colour	white, yellow
Possible printing systems	Laser printer, Matrix printer Plotter
Verwendbare Hülsen	WPT, WPM

Ordering data

Type	Order No.
WPF 1/21 white	1600741044
WPF 1/21 yellow	1600741687
WPF 2/17,5 white sheets	1764050000

TM-I

Insert tags



Easy to fit and secure attachment thanks to the special contour of the TM-I. They are compatible with numerous commercially available sleeves. The MultiCard format means that the tags can be rapidly and easily printed with the printing systems SMark-Laser, PrintJet, Plotter, MC-Mobilo or the STI pen. Thanks to the project marker surface of the MultiCard, they can easily be separated and then attached.

Technical data

Material	Polyamide, halogen-free
Flammability class to UL 94	V2
Temperature range	-40°C to + 100°C
Dimensions	12 x 4, 15 x 4, 18 x 4, 20 x 4, 30 x 4 mm
Colour	white, yellow, red, blue, green
Possible printing systems	Plotter, SMark-Laser, PrintJet, MC-Mobilo
Wipe resistance	In accordance with IEC 50
Order software	M-Comm2
For custom print	(Order No. 1753350000)

Ordering data

Type (length)	Colour	Qty.	Order No.
TM-I 12 MC NEUTRAL WS	white	320	1718411044
TM-I 12 MC NEUTRAL RT	red	320	1718411686
TM-I 12 MC NEUTRAL GE	yellow	320	1718411687
TM-I 12 MC NEUTRAL GN	green	320	1718411688
TM-I 12 MC NEUTRAL BL	blue	320	1718411693
TM-I 15 MC NEUTRAL WS	white	400	1609981044
TM-I 15 MC NEUTRAL RT	red	400	1609981686
TM-I 15 MC NEUTRAL GE	yellow	400	1609981687
TM-I 15 MC NEUTRAL GN	green	400	1609981688
TM-I 15 MC NEUTRAL BL	blue	400	1609981693
TM-I 18 MC NEUTRAL WS	white	320	1718431044
TM-I 18 MC NEUTRAL RT	red	320	1718431686
TM-I 18 MC NEUTRAL GE	yellow	320	1718431687
TM-I 18 MC NEUTRAL GN	green	320	1718431688
TM-I 18 MC NEUTRAL BL	blue	320	1718431693

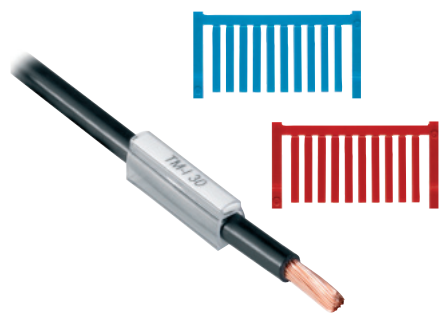

There are five marker lengths available for custom prints with long sequences of characters.

- Project marker surface for easy separation and attachment
- Approved and listed markers for traffic engineering
- Top flexibility through advanced attachment of sleeve and retrospective fitting of tags

Ordering data

Type (length)	Colour	Qty.	Order No.
TM-I 20 MC NEUTRAL WS	white	400	1680411044
TM-I 20 MC NEUTRAL RT	red	400	1680411686
TM-I 20 MC NEUTRAL GE	yellow	400	1680411687
TM-I 20 MC NEUTRAL GN	green	400	1680411688
TM-I 20 MC NEUTRAL BL	blue	400	1680411693
TM-I 30 MC NEUTRAL WS	white	300	1876390000
TM-I 30 MC NEUTRAL RT	red	300	1876380000
TM-I 30 MC NEUTRAL GE	yellow	300	1876370000
TM-I 30 MC NEUTRAL BL	blue	300	1876400000
Custom print			
TM-I 12 MC CUSTOM PRINT		64	1718420000
TM-I 15 MC CUSTOM PRINT		80	1609990000
TM-I 18 MC CUSTOM PRINT		64	1718440000
TM-I 20 MC CUSTOM PRINT		80	1680420000
TM-I 30 MC CUSTOM PRINT		60	1876320000

Markers for devices and installations

Device and installation markers round off the range of switchgear markers. By utilising Weidmüller's device markers, users comply with official regulations requiring marking of electrical equipment. Weidmüller offers corresponding markers for devices made by well-known manufacturers. Mirroring their original counterparts, these tags are available with the classic adhesive or rapid clip-on attaching techniques. By utilising the corresponding software and system-compatible printer or plotter system, users can print their own markings on the device markers.

Weidmüller also offers ready-to-use printed labels in the form of a Symbol Packs or Service Packs.

A samples bag containing a selection of device and installation markers is available under the order no. **1646370000**.

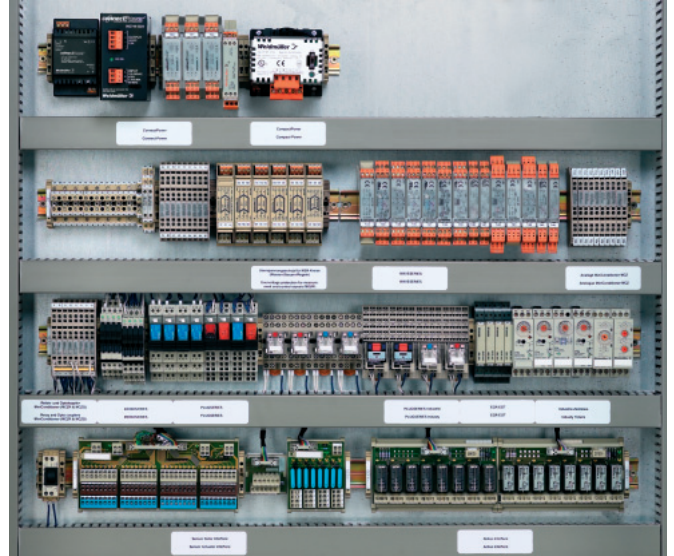

SwitchMark

ESG

ClipCard



	SwitchMark	ESG	ClipCard
Cable ducts			●
Automatic switchgear	●	●	●
Contactors	●	●	
Electrical connections			●
Electrical devices			●
Machines			
LED displays	●		
Keyboards	●		
Lamps			●
Murr valve plug		●	
Tubes			●
Circuit-breakers		●	
Relays		●	
Maintenance			
Shelves			
Switches	●	●	●
Control desk	●	●	●
Transformers		●	
Valves			●

ESG tag

ESG is the proven marker in MultiCard format for many well-known electrical devices. The result is high-quality device markings with a contrast-rich appearance.

We offer versions for the devices produced by the following manufacturers:

- ABB
- Siemens
- Moeller
- Télémécanique
- For universal use, self-adhesive or clip-on tags are available (depending on the type)

ESG for clipping onto tag rails; suitable for devices mounted in rows, such as miniature circuit-breakers.

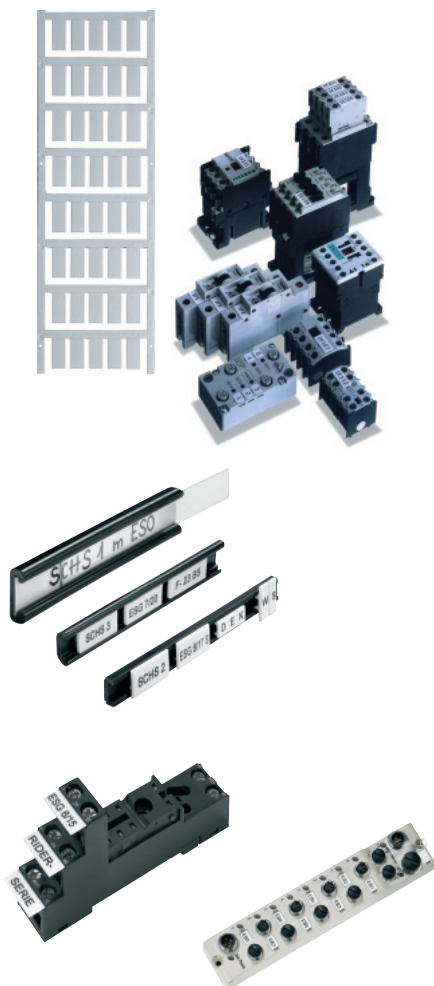

Technical data

Colour	White, yellow (turquoise, ESG 7/20 only)
Wipe resistant	In accordance with DIN IEC 50
Adhesive force on stainless steel	K = normal adhesive 22 N/m
Material	Polyamide, halogen-free
Flammability class to UL 94	V2
Temperature range	-40 °C ... +100 °C
Possible printing systems	PrintJet, Plotter, SMark-Laser, MC-Mobilo

Ordering data

Type neutral	Application	W / L	Qty.	Order No.
ESG 6/15 K MC NEUTR. GE	Self-adhesive	6 x 15	200	1880130000
ESG 6/15 K MC NEUTR. WS	Self-adhesive	6 x 15	200	1880100000
ESG 6/15 MC RIDERSERIES	Riderserie SCM/SRC	6 x 15	200	1881280000
ESG 6/17 K MC NEUTR. GE	Self-adhesive	6 x 17	200	1880110000
ESG 6/17 K MC NEUTR. WS	Self-adhesive	6 x 17	200	1880120000
ESG 7/20 SIRIUS GE	Siemens Sirius 3R / tag rail 3 u. 4	7 x 20	200	1736181687
ESG 7/20 SIRIUS TURQUOISE	Siemens Sirius 3R	7 x 20	200	1736181696
ESG 7/20 SIRIUS WS	Siemens Sirius 3R	7 x 20	200	1736181044
ESG 8/10 ASI	Siemens AS-interface	8 x 10	200	1736190000
ESG 8/17 MC NEUTRAL	Télémécanique	8 x 17	200	1674740000
ESG 8/17 SYS PRO M	GE power Controlls (AEG); ABB-Stotz	8 x 17	200	1755340000
ESG 8/17 SCHS MC NEUTR.	Tag rail SchS2	8 x 17	200	1720610000
ESG 8/17 L MC NEUTRAL	Lumberg distributor	8 x 17	200	1890470000
ESG 8/19 MC NEUTRAL	AEG	8 x 19	200	1652220000
ESG 9/10 MC neutral WS		9 x 10	200	1775910000
ESG 9/11K MC Neutral	Self-adhesive	9 x 11	200	1857440000
ESG 9/17 MC NEUTRAL	Insert tag	9 x 17	200	1724760000
ESG 9/17 K NEUTRAL/GE	Self-adhesive	9 x 17	200	1753500000
ESG 9/17 K NEUTRAL/WS	Self-adhesive	9 x 17	200	1674760000
ESG 10/17 MC Neutral	Allen Bradley / Festo MT	10 x 17	200	1856700000
ESG 9/20 L MC NEUTRAL	Lumberg distributor	9 x 20	200	1890460000
ESG 9/20 MC neutral, without foot	Insert tag for TMC sleeve	9 x 20	200	1770500000
ESG 9/20 MC NEUTRAL GE	Siemens + Moeller+WI SAI distributor	9 x 20	200	1766160000
ESG 9/20 MC NEUTRAL WS	Siemens + Moeller+WI SAI distributor	9 x 20	200	1609940000
ESG 9/20 MC Universal	Siemens + Moeller+WI and Murr SAI distributor + Festo CPV/CPI	9 x 20	200	1856720000

Tag rail			Order No.
Tag rail SchS1	for ESO with protective strip	Length 1 m	0138900000
Tag rail SchS2	for ESG 18/17 S ; DEK ; WS	Length 1 m	0337400000
Tag rail SchS2, self-adhesive	for ESG 18/17 S ; DEK ; WS	Length 1 m	1720600000
Tag rail SchS3 white, self-adhesive	for ESG 7/20	Length 1 m	1753480000
Tag rail SchS4 grey, self-adhesive	for ESG 7/20	Length 1 m	1753460000
ESO/SCHS1 500X12,5X0,3	Insert strips for SCHS1	Length 0.5 m	0139000000
STR SCHS1	Protective strip for SCHS1	Length 0.5 m	0139200000

Type custom print	Colour and print details	Qty.	Order No.	
ESG 6/15 K		6 x 15	40	1880090000
ESG 6/15 RIDERSERIE		6 x 15	40	1881290000
ESG 6/17 K		6 x 17	40	1880080000
ESG 7/20 SIRIUS		7 x 20	40	1766650000
ESG 8/10 ASI		8 x 10	40	1770470000
ESG 8/17		8 x 17	40	1674750000
ESG 8/17 SYS PRO M		8 x 17	40	1755350000
ESG 8/17 SCHS		8 x 17	40	1766640000
ESG 8/19 MC		8 x 19	40	1652230000
ESG 9/11 K		9 x 11	40	1857450000
ESG 9/17		9 x 17	40	1770480000
ESG 9/17 K		9 x 17	40	1674770000
ESG 10/17		10 x 17	40	1856710000
ESG 9/20, without foot		9 x 20	40	1770510000
ESG 9/20		9 x 20	40	1609950000
ESG 9/20 MC Universal		9 x 20	40	1856730000

SwitchMark SM

SwitchMark (SM) markers are used to identify command and signalling devices. The tags are either snapped into the holder or secured by means of the self-adhesive foil on their rear. Individual custom prints can be created using the printing system SMark-Laser, PrintJet, Plotter or MC-Mobilo.

- Create individual custom prints utilising Weidmüller's marking system for MultiCards.
- Fast production of custom prints to in-house specifications.
- No need to store expensive standard tags.
- Extremely resistant print quality with PrintJet instead of engraving.
- We recommend the protective foil ETO SM for extreme conditions.

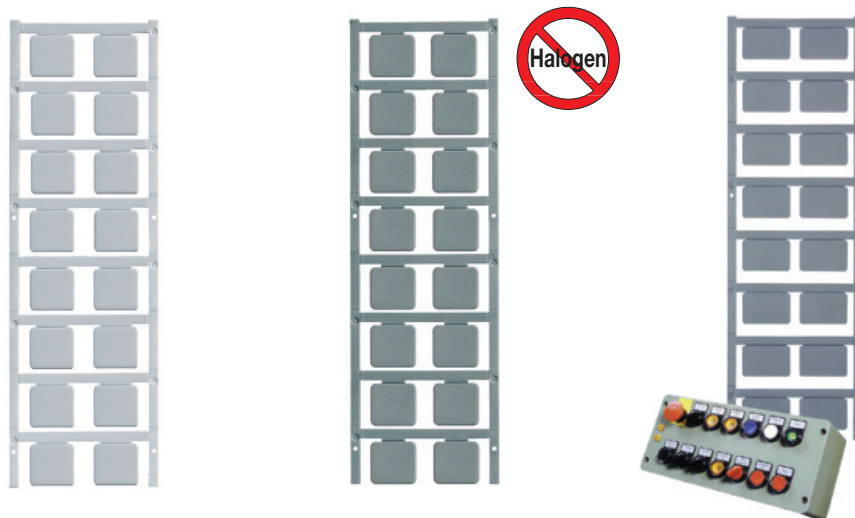

Technical data

Material	Polyamide 66, halogen-free
Flammability class to UL94	V2
Temperature range °C	-40...100



SwitchMark Neutral

Type	Length (mm)	Width (mm)	Qty.	Order No.
				white
SM 27/8	8	27	80	1699820000
SM 27/12,5	12.5	27	80	1699840000
SM 27/18	18	27	80	1699860000
SM 27/27	27	27	60	1773220000
				silver
				1713680000
				1713700000
				1713740000
				1773230000

SwitchMark neutral, self-adhesive

Type	Length (mm)	Width (mm)	Qty.	Order No.
				white
SM 27/8 K	8	27	80	1812630000
SM 27/12,5 K	12.5	27	80	1699880000
SM 27/18 K	18	27	80	1707270000
SM 22/22 K	22	27	80	1877570000
SM 27/27 K	27	27	60	1783000000
				silver
				1771930000
				1713720000
				1713760000
				1877590000
				1782990000

SwitchMark custom print

Type	Length (mm)	Width (mm)	Qty.	Order No.
				Colour and print details
SM 27/8	8	27	80	1699830000
SM 27/8 K	8	27	80	1713690000
SM 27/12,5	12.5	27	80	1699850000
SM 27/12,5 K	12.5	27	80	1699890000
SM 27/18	18	27	80	1699870000
SM 27/18 K	18	27	80	1707280000
SM 22/22 K	22	27	80	1877580000
SM 27/27	27	27	60	1773240000
SM 27/27 K	27	27	60	1783010000

ClipCard

ClipCard device markers in MultiCard format offer an interesting alternative to **engraving**. This assortment is used to mark electrical installations and switchgear. The proven MultiCard format means it is possible to print with any of the SMark-Laser, PrintJet, Plotter and MC-Mobilo printers.

- Extremely resilient print quality with PrintJet instead of engraving
- Universal attachment
 - Holder (screw attachment or with cable tie)
 - Tag rail (self-adhesive and screw attachment)
 - or self-adhesive markers
- For extreme conditions, we recommend:
 - Protective strips (holder)
 - Protective rail (CC-Rail)
 - Protective foil for markers (see page 38)

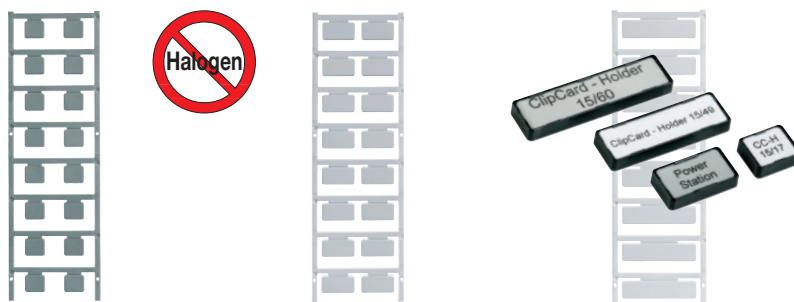

Technical data

Material	Polyamide 66, halogen-free
Flammability class to UL94	V2
Temperature range °C	-40...100

ClipCard neutral

Type	Length (mm)	Width (mm)	Qty.	Order No.	white	silver
CC 15/17 MC	17	15	80	1876570000		1876610000
CC 15/27 MC	27	15	80	1876770000		1876760000
CC 15/49 MC	49	15	40	1877260000		1877240000
CC 15/60 MC	60	15	40	1877350000		1877340000

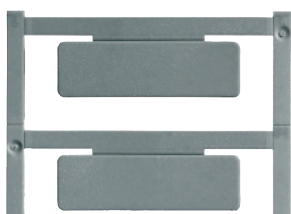

ClipCard neutral, self-adhesive

Type	Length (mm)	Width (mm)	Qty.	Order No.	white	silver
CC 15/17 K MC	17	15	80	1876590000		1876580000
CC 15/27 K MC	27	15	80	1876640000		1876780000
CC 15/49 K MC	49	15	40	1877220000		1877270000
CC 15/60 K MC	60	15	40	1877310000		1877360000



Custom print

Type	Length (mm)	Width (mm)	Qty.	Order No.	Colour and print details
CC 15/17 MC	17	15	16	1876620000	
CC 15/17 K MC	17	15	16	1876600000	
CC 15/27 MC	27	15	16	1876630000	
CC 15/27 K MC	27	15	16	1876750000	
CC 15/49 MC	49	15	8	1877200000	
CC 15/49 K MC	49	15	8	1877230000	
CC 15/60 MC	60	15	8	1877300000	
CC 15/60 K MC	60	15	8	1877320000	

Device markers

SwitchMark SM

Accessories



The device and installation markers are either snapped into the holder or secured by means of the self-adhesive foil on their rear.

- For example: insert the SM 27/18 into the holder that we offer as well as the markers
- We recommend that the transparent protective foil ETO SM be used if the print is subjected to extreme demands with respect to their wipe and scratch resistance in the presence of chemicals

Ordering data **SwitchMark SM**

Type	Qty.*	Order No.
Holder, black		
SM-H 27/12,5	25	1716640000
SM-H 27/18	25	1716630000
SM-H 27/27	20	1782710000
Protective foil		
ETO SM 27/8	1 (165)	1720570000
ETO SM 27/12,5	1 (100)	1720580000
ETO SM 27/18	1 (112)	1720590002
ETO SM 22/22	1 (112)	1880720000
ETO SM 27/27	1 (70)	1805840000
* Details in round brackets indicate the number of markers per sheet		

ClipCard CC

Accessories



Universal attachment options with the possibility of being mounted either in a holder, per cable tie or screw as well as by utilising CC-Rail tag rails.

- Universal attachment options: per holder, cable tie or screw as well as by means of a tag rail
- For extreme conditions, we recommend:
 - Protective strips (holder)
 - Protective rail (CC-Rail)
 - Protective foil for markers (see page 38)

Ordering data **ClipCard CC**

Type	Qty.*	Order No.
Holder		
CC-H 15/17	75	1790430000
CC-H 15/27	45	1790410000
CC-H 15/49	25	1790420000
CC-H 15/60	25	1878910000
Protective strips		
STR CC 15/17	80	1888310000
STR CC 15/27	80	1888290000
STR CC 15/49	40	1888300000
STR CC 15/60	40	1888280000
Protective foil		
ETO CC 15/17	1 (228)	1880850000
ETO CC 15/27	1 (133)	1880810000
ETO CC 15/49	1 (76)	1880830000
ETO CC 15/60	1 (57)	1880840000
Tag rails		
CC-Rail 1000	1	1790150000
CC-Rail 1000 transparent	1	1790160000
* Details in round brackets indicate the number of markers per sheet		

Overview of printers and software

Weidmüller's printing systems allow you to print your terminal markers, wire and cable markers as well as your device markers – fast and reliably. The **M-Print PRO** software offers top of the range data conversion routines. Data integration progresses to being a means for work organisation when additional contract data is also added to the pure data for markings – meaning the project, customer or the arrangement.

M-Print PRO offers true user-friendly operation under Windows.

Weidmüller's printers **PrintJet**, **SMark-Laser printer** or **MC-Mobilo** are available for printing out jobs. PrintJet is the best example of clear-cut printing quality. SMark-Laser printers are distinguished by their speed and the resilience of their prints. As well as the ease with which they can be installed, project assignment details on project marker surfaces are a further highlight of printed MultiCards.



SMark-Laser



PrintJet



MC-Mobilo

Markers	Software ³	Printers		
	M-Print PRO	SMark-Laser	PrintJet	MC-Mobilo
Terminal markers				
DEK	●	●	●	●
WS	●	●	●	● ¹
ZS	●	●	●	●
MF	●	●	●	●
GWS	●	●	●	●
Wire markers				
SF	●	●	●	● ²
SFX	●	●	●	●
SFC	●	●	●	●
TM-I	●	●	●	●
WKS	●			
Device markers				
ESG	●	●	●	●
SM	●	●	●	●
ClipCard	●			

¹ Sußer WS 15/5.

² SF 4, 5 and 6 with corresponding support frame only

³ Three demonstration versions of our software are available from our homepage www.weidmueller.de

PrintJet II

The **PrintJet printer** allows you to print customised marker prints for terminal blocks, switchgear, cables, wires and circuit-breakers at your convenience.

- Sharp print contours
- High-contrast typeface
- Extremely resilient lettering
- Permanently readable identification
- Fast and user friendly
- Compatible with all MultiCards
- The PrintJet-Loader holds up to 20 MultiCards

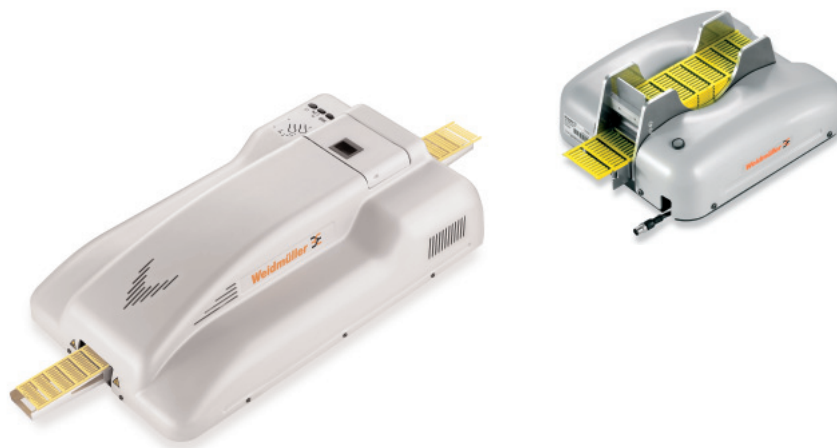

Technical data

Type	PrintJet II
Application	Prints MultiCard markers
Technology	Ink-jet process
Print quality	2880 dpi
Printer drivers	Win 9X, Win NT, Windows 2000
Print software	Recommended: M-Print 1.60
System requirements	Windows 95/98/NT/2000/XP
Feed	Manual or with optional loader
Fusing	Thermal fusing
Interface	Centronics and USB
Connection	AC 230 V/AC 115 V
Location	Office conditions
Ambient temperature	20 °C – 35 °C
Dimensions (L x W x H)	800 x 450 x 200 mm
Cartridge system	Ink cartridge, black (210 000 characters, Arial font size 6); average print performance per day: 20 MultiCards; max. print performance per day: 100 MultiCards
Range of supply	PrintJet printer, power cable, printer drivers, manuals (CD), cleaning unit, Centronics cable, software M-Print

PrintJet-Loader

System requirements	PrintJet printer
Marker types	MultiCard format
Operating voltage	12 V/DC
Current input	approx. 1 A
Interface	Connection via plug-in connector
Location	Office conditions
Ambient temperature	20 °C – 35 °C
Dimensions (L x W x H)	345 x 305 x 155 mm
Weight	4 kg

Ordering data

PrintJet II

Type	Order No.
PrintJet II 115 V	1858980000
PrintJet II 230 V	1858990000
PrintJet-Loader	1813090000
Accessories	
Ink cartridge PrintJet II	1858920000
Clean Unit PrintJet II	1858950000
Ink cartridge PrintJet	1797460000
Clean Unit PrintJet	4062150000

SMark-Laser

The SMark-Laser has brought speed to the world of markings.

- Fast printing speed
- 4 MultiCards per minute
- Top print quality
- Markers immediately ready for use
- Works fast, independent of the amount of data
- Extreme flexibility through production of markers in MultiCard format to suit your needs
- Reduced storage, because only neutral markers are required
- Suitable for graphics
- Compatible with all standard operating systems (for example, WIN 3x, WIN 9x, OS/2, NT, WIN 2000, XP)
- Standard software compatible
- Optional automatic feed for larger jobs
- Replaceable toner cartridge with handle
- Compatible with Weidmüller software 'M-Print', order no.: **1784560000**.



Technical data

Type	SMark-Laser
Application	Prints all MultiCards
Technology	Laser printer
Printing speed	4 MultiCards per minute
Print quality	600 dpi
Printer drivers	WIN3.x, 9x, NT, HP III compatible
Software	M-Print settings, commercially-available standard software
System requirements	Windows 95/98/NT/2000/XP
Feed	Manual or with optional loader
Interfaces	Centronics optional, Apple Talk
Supply voltage	AC 230 V / 50 Hz / 16 A
Ambient conditions	20 °C – 35 °C
Dimensions: (L x W x H)	1000 x 430 x 380 mm
Range of supply	Laser printer, power cable, printer drivers, manual, interface cable, M-Print software

Ordering data

SMark-Laser

Type	Order No.
SMark-Laser	1767090000
Rack	1782880000
Special toner cartridge	1770070000

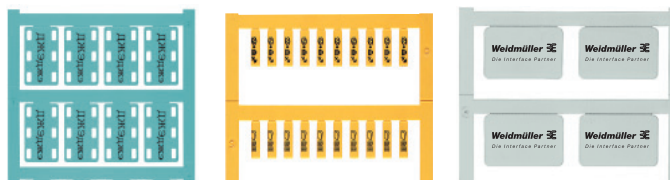

Print options

Printers

Accessories for Plotter IP-220 Standard

STI-S

MC-Mobilo

STI-S pen with adapter



Adapter for STI-S



Plotter pen



INK 2000 drawing ink and CLEAN 2000 cleaner

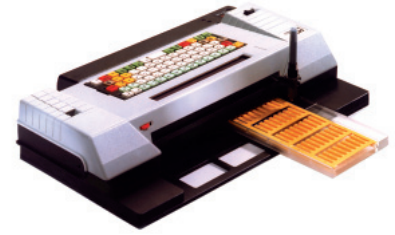

for marking:

- MultiCards
- WS strips, Dekafix cards (inlay required)
- PA 02, PA1, PK 2/25, PK 2/40 (inlay required)
- LogiMark, WKS, E-Fix, VarioCut (cutting option required)
- SlimFix 1, 2, 3 and SFX (not SlimFix 4 and 5)

The STI-S fibre pen is ideal for marking neutral Weidmüller marker products. It is suitable for marking manually or in conjunction with the STI-S adapter for plotter printing. Black, water-resistant ink is used.

MC-Mobilo is the key to printing without a computer or mains supply. Users are able to work in the field with the MC-Mobilo, without the need for an established workstation. Once charged, the battery will last for approx. 3 hours. Utilising the universal inlay allows practically all MC MultiCards to be processed.

Ordering data

Plotter IP-220

Type	Order No.
MC Wago/Phoenix adapter plates	1754980000
Murr/Wago adapter plates (Roland 5 MC'S 1150 A)	1754990000
Murr plastic adapter plates (Roland 4 MC'S 1150)	1755030000

Ordering data

Pen/adapter

Type	Order No.
Plotter pen 0.18	1768570000
Plotter pen 0.25	1768540000
Plotter pen 0.35	1768550000
Plotter pen 0.5	1768560000
Plotter adapter (without nib)	1684480000
Plotter nib BTS 0.25 mm	1603360000
Plotter nib BTS 0.35 mm	1603370000
Plotter nib BTS 0.50 mm	1603380000
Trial installation/instruction IP 220 (within Germany only)	1546800000
Adapter for STI-S	1762440000
STI-S pen	0508401694
Ink and cleaner	
Ink 2000 drawing ink	1772120000
Clean 2000 cleaner	1772130000
Permanent fibre pen set (5 items, partially non-fading, for labels only)	1730470000
Print kit consisting of Ink 2000, Clean 2000 cleaner and BTS 0.25 + adapter	1686920000

Ordering data

MC-Mobilo

Type	Order No.
MC-Mobilo basic device* 230 V Includes MC configuration, battery pack and charger in a portable case (German, English, French)	1741260001
MC-Mobilo basic device* 110 V Includes MC configuration, battery pack and charger in a portable case (German, English, French)	1741260002
Including universal inlay for all MC and SF cards up to size 3 with interfaces (9-pole) + software	

* Please indicate required model (USA, GB, Europe)

M-Print® PRO Label Designer

Print and ordering software for markers and labels

M-Print® PRO is a professional software for printing and ordering Weidmüller markers and labels under Windows®. This software helps you to optimise your processes for marking electrical equipment. You can design, print and order your marking material effortlessly, professionally and quickly: texts, frames, lines, graphics, barcodes, serial numbers and photos.

Here is an overview of the main functions:

- Integrated product catalogue for all labels and markers, including images and links to the relevant web pages and product data sheets
- Markers and labels can be designed in as many levels as required
- Custom formatting of individual text characters (RTF)
- Perform copy-and-paste functions with texts and their formats
- Supports UNICODE for foreign-language texts, such as Russian, Chinese, Polish, ect.
- Enter data in labels and table sheet
- Permanent print preview: see how the printout will look during design phase
- Alphanumeric counts and sequences
- Extensive range of image formats (*.bmp, *.wmf, *.png, *.ico, *.jpeg, *.tif, *.gif)
- Image library including all of the important symbols used in electrical engineering
- Assign product to specific printer; for example, ESG 9/20 to PrintJet, LaserMark to laser printer, ect.
- Supported output devices: PrintJet I+II, SMark-Laser, ThermoCard, THM as well as standard printers with Windows drivers
- Optimum and rapid adjustment of the output devices
- Online update service via Internet
- Interface to RailDesigner®
- Import assistant to create your own import filter for numerous file formats (*.txt, *.asc, *.mak, *.wei, *.tmf, ect.)
- Integrates data from CAE systems

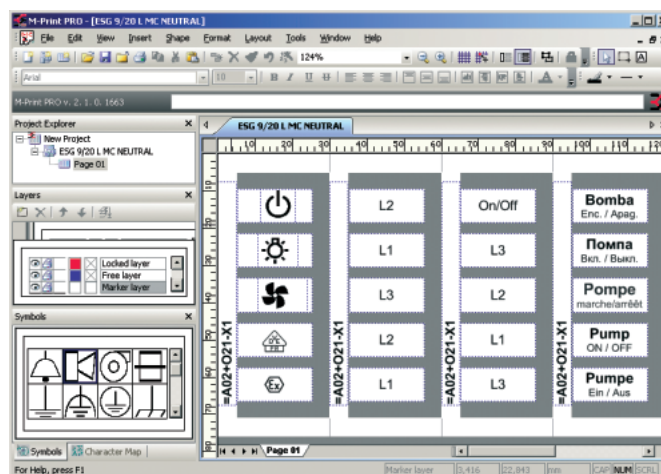

Supported operating systems:

WINDOWS® 98 SE, ME, NT, 2000, XP, Server 2003

System requirements:

- RAM: > 64 MB
- Processor: > Pentium PIII or comparable model
- Graphic: > 800 x 600 pixels with 256 colours
optimum: 1024 x 768 with 16-bit High Colour
- Hard disk: > 90 MB free storage
- Miscellaneous: mouse, keyboard, CD-ROM drive (to install the software)

M-Print® PRO is available in two editions:

M-Print® PRO Standard Edition for professional printing results with all of Weidmüller's marking materials

M-Print® PRO Advanced Edition for professional printing results with all of Weidmüller's marking materials and customer specific labels

Ordering data

M-Print® PRO

Type	Order No.
M-Print® PRO	1905490000
M-Print® PRO advanced	1905500000

Cable ties

Cable ties keep things tidy in numerous fields of installations. Distinguishing features include an immense tying force plus a long service life. In addition, steel cable ties offer extremely durable attachment options that are capable of withstanding extreme material stresses caused by high temperatures or the powerful effects of chemicals.

CB

CB cable ties provide secure attachment options for cables and markings. They are particularly suitable for attaching PK, SFX, WKM and WKS cable markers. The material is composed of unbreakable polyamide PA 6.6 with flammability class V2 to UL94.

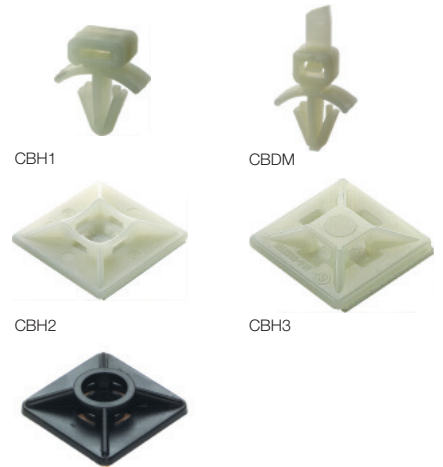

Technical data

Material			
Material		Polyamide	
Dimensions			
Flammability class to UL94		V2	
Dimensions		Length (mm)	Width (mm)
CB 750/7.8		750	7.8
CB 365/7.8		365	7.8
CB 360/4.8		360	4.8
CB 290/4.8		290	4.8
CB 290/3.6		290	3.6
CB 200/4.8		200	4.8
CB 200/3.6		200	3.6
CB 178/4.8		178	4.8
CB 160/4.5		160	4.5
CB 140/3.6		140	3.6
CB 98/2.5		95	2.5

Ordering data

Type	Colour	Qty.	Order No.
CB 750/7.8	natural	100	1720680000
CB 750/7.8	black	100	1720670000
CB 365/7.8	natural	100	1279100000
CB 365/7.8	black	100	1697940000
CB 360/4.8	natural	100	1279000000
CB 360/4.8	black	100	1697930000
CB 290/4.8	natural	100	1278900000
CB 290/4.8	black	100	1697920000
CB 290/3.6	natural	100	1720640000
CB 290/3.6	black	100	1720650000
CB 200/4.8	natural	100	1278800000
CB 200/4.8	black	100	1697910000
CB 200/3.6	natural	100	1720630000
CB 200/3.6	black	100	1720660000
CB 170/4.8	natural	100	1723550000
CB 170/4.8	black	100	1723570000
CB 160/4.5	natural	100	1723540000
CB 160/4.5	black	100	1723560000
CB 140/3.6	natural	100	1278700000
CB 140/3.6	black	100	1697900000
CB 98/2.5	natural	100	1278600000
CB 98/2.5	black	100	1697890000

Technical data

Material	
Polyamide	
Flammability class	
V2 to UL 94	
CBDM	Cable ties for direct installation of cable harness max. ϕ : 44.5 mm Total length: 200 mm
CBH 1	Cable tie retainer for use on mounting plate Max. plate thickness 3.2 mm Hole ϕ max. 6.2 mm
CBH 2	Cable tie retainer for sticking to surface: 19 x 19 mm
CBH 3	Cable tie retainer for sticking to surface: 27 x 27 mm

Ordering data

Type	Colour	Qty.	Order No.
CBDM	natural	100	1279330000
CBH 1	natural	100	1279200000
CBH 2	natural	100	1289200000
CBH 3	natural	100	1289400000
CBH 2	black	100	1697950000
CBH 3	black	100	1697960000

Worldwide activities

- A Austria**
Weidmüller Ges.m.b.H.
Industriezentrum Nö Süd
Straße 2, Objekt M2
2355 Wiener Neudorf
Phone +43 2236 6708-0
Fax +43 2236 6708-199
office.at@weidmueller.com
- ADN Yemen**
Please contact
Weidmüller Middle East
United Arab Emirates
- AUS Australia**
Weidmüller Pty. Ltd.
43 Huntingwood Drive
Huntingwood,
NSW, 2148
P.O.Box 6944
Blacktown
NSW, 2148
Phone +61 2 9671-9999
Fax +61 2 9671-9911
info@weidmuller.com.au
www.weidmuller.com.au
- B Belgium**
Weidmüller Benelux B.V.
Ambachtenlaan 11 A
3001 Heverlee
Phone +32 16 395990
Fax +32 16 401051
info@weidmueller.be
- BA Bosnia-Herzegovina**
BH ES Elektrosistem d.o.o.
ul. J. Veselinovica 18
78000 Banja Luka
Bosna
Phone +387 51 317500
Fax +387 51 317500
elsist@inecco.net
www.elektrosistem.co.yu
- BG Bulgaria**
Weid-Bul eOOD
ul. Nezabavka 33 A,
bl. 315/3/10
1113 Sofia
Phone +359 2 9632560
Fax +359 2 9631098
weidbul@nat.bg
- BR Brazil**
Conexel Conexoes Elétricas Ltda.
Rua Garcia Lorca, 176- V. Paulicéia,
09695-900, Sao Bernardo do
Campo - SP, Brasil
Phone +55 11 43669600
Fax +55 11 43621677
vendas@conexel.com.br
www.conexel.com.br
- BRN Bahrain**
Khayber Trading Company
P.O. Box 1976 Manama,
Bahrain
Phone +973 720 747
Fax +973 720 331
khayber@batelco.com.bh
- BY Belarus**
TECHNIKON Ltd.
Oktyabrskaya Str. 16/5
Apt. 704
220030 Minsk
Belarus
Tel. +375 17 2104626
Fax +375 17 2275830
technikon@belsonet.net
- CDN Canada**
W Interconnections Canada Inc.
10 Spy Court, Markham,
Ontario L3 R5 H6
Phone +1 905 475-1507
Fax +1 905 475-5855
info1@weidmuller.ca
www.weidmuller.ca
- CH Switzerland**
Weidmüller Schweiz AG
Rundbuckstrasse 2
8212 Neuhausen am Rheinfall
Phone +41 52 6740707
Fax +41 52 6740708
mail:info@weidmueller.ch
www.weidmueller.ch
- CN China**
Weidmüller Interface International
Trading (Shanghai) Co., Ltd.
Unit 503-504 Central Plaza,
No. 227 Huangpi N. Rd.,
200003 Shanghai
P.R. China
Phone +86 21 63758766
Fax +86 21 63759077
www.cnweidmuller.com
- CO Columbia**
Automatizacion Avanzada S. A.
Carrera 97 No. 42 A-23 B3,
Santafe de Bogotá Colombia.
Phone +57 1 4132048
Fax +57 1 4159788
mgallegos@
automatizacionavanzada.com
- CR Costa Rica**
ELVATRON S.A.
400 Norte
Banco Costa Rica, la Uruca,
San José, Costa Rica
Phone +506 2 961060
Fax +506 2 960328
dirk.haase@elvatron.com
- CZ Czech Republic**
Weidmüller s. r. o.
Videnska ul. 340
25242 Vestec u Prahy
Phone +420 2 44001400
Fax +420 2 44001499
office@weidmueller.cz
- D Germany**
Weidmüller GmbH & Co. KG
Ohmstraße 9
32758 Detmold
Phone +49 5231 1428-0
Fax +49 5231 1428-116
weidmueller@weidmueller.de
www.weidmueller.de
- DK Denmark**
Knud Wexøe A/S
Skaettekaeret 11
P.O. Box 152
2840 Holte
Phone +45 45465800
Fax +45 45465801
wexoe@wexoe.dk
- E Spain**
Weidmüller S. A.
Narcis Monturiol 11-13
Pol.Ind. Sudcoeste
08960 Sant Just Desvern
Barcelona
Phone +34 93 4803386
Fax +34 93 3718055
weidmuller@weidmuller.es
www.weidmuller.es
- ES El Salvador**
Please contact
ELVATRON S. A., Costa Rica
- EST Estonia**
Alter Electric OÜ
Turi 6, 11313 Tallinn, Estonia
Phone +372 65 19 666
Fax +372 65 19667
alter@alter.ee
- ET Egypt**
Standard Electric
5, Heliopolis Hospital Street,
Cairo, Egypt
Phone +20 2 6444182
Fax +20 2 6444191
stdelec@click.com.eg
- F France**
Weidmüller EURL
12, Chaussée Jules César
B.P. 263 Osny
95523 CERGY PONTOISE Cedex
Phone +33 1 34245500
Fax +33 1 34245501
mail@weidmuller.fr
www.weidmueller.com
- FIN Finland**
JUHA-ELEKTRO OY
Kylvöpolku 6
P. O. Box 57
00681 Helsinki
Phone +358 9 478411
Fax +358 9 47841311
- GB United Kingdom**
Weidmüller Ltd.
1 Abbey Wood Road
Kings Hill
West Malling
Kent ME19 4YT
Phone +44 1732 877032
Fax +44 1732 873873
info@weidmuller.co.uk
www.weidmuller.com
- GCA Guatemala**
Please contact
ELVATRON S. A., Costa Rica
- GR Greece**
Electrorama S.A.
1 An. Martali Str.
41335 Larissa
Phone +30 2410 552533
Fax +30 2410 283463
valvizos@electrorama.com.gr
- H Hungary**
Weidmüller Kereskedelmi Kft
Dombóvári út 13
1117 Budapest
P. O. Box 22
1507 Budapest
Phone +36 1 464-7888
Fax +36 1 3827701
info@weidmueller.hu
- HK Hong Kong**
United Equity Limited
Suite B, 11/F International Industrial
Centre
2-8 Kwei Tei Street, Fotan
Shatin, N. T.
Phone +852 26876739
Fax +852 26876735
- HKJ Jordan**
Please contact
Weidmüller Middle East
United Arab Emirates
- HO Honduras**
Please contact
ELVATRON S. A., Costa Rica
- HR Croatia**
Elektro Partner d.o.o.
Radnicka cesta 22
10000 Zagreb
Phone +385 1 6184793
Fax +385 1 6184795
elektropartner@zg.htnet.hr
- I Italy**
Weidmüller S.r.l.
Via Albert Einstein 4
20092 Cinisello Balsamo
Milano
Phone +39 02 660681
Fax +39 02 6124945
weidmuller@weidmuller.it
www.weidmuller.it
- IL Israel**
A.U. Shay Ltd.
Embar Street 23/25
P.O.Box 10049
Petach-Tikva 49222
Phone +972 3 9233601
Fax +972 3 9234601
shay@uriel-shay.com
- IND India**
Weidmüller Representative office
Vijay Dattani
119, Prashanth Extention
Whitefield
Bangalore - 560 066
Phone +91 80 8453999
Fax +91 80 8453999
- IR Iran**
TAF Co.
72, Iranshahr Av.
Unit 5,
15816 Teheran
Phone +98 21 831-7851
Fax +98 21 882-0268
tafco@safinoh.net
- IRL Ireland**
A.P. Haslam Ltd.
14 Sunshine Ind. Estate
Crumlin Road
Dublin 12
Phone +353 1 453-2522
Fax +353 1 453-2949
paul.haslam@aphaslam.ie
- IS Iceland**
Samey Automation Center
Lyngas 13, 210 Garoabaer,
Island
Phone +354 510 5200
Fax +354 510 5201
samey@samey.is
- J Japan**
Nihon Weidmüller Co. Ltd.
Asahi Seimei Bldg. 11F
1-14-1 Fuchicho Fuchu-shi
Tokyo 183-0055 Japan
Phone +81 42 330-7891
Fax +81 42 330-7895
www.weidmuller.co.jp
- KWT Kuwait**
NOURI Industrial Establishment Co.
P.O.Box 2829,
Safat 13029 Kuwait
Phone +965 4333355
Fax +965 4344085
contact@nie-kwt.com
- L Luxembourg**
Please contact
Weidmüller Belgium, Heverlee
- LT Lithuania**
ELEKTROS IRANGA
Tinklų g.29a, 5319 Panevezys,
Lithuania
Phone +370 45582828
Fax +370 45582727
info@eliranga.lt
- LV Latvia**
Elektrosistemas
Kuldigas St. 51,
1046 Riga, Latvia
Phone +371 7070140
Fax +371 7070141
edgars.vilkins@elektrosistemas.lv
- MA Morocco**
Energy-Technics Transfer, S.A.
23 Boulevard Lieutenant
Mohamed El Bakai Tamri
Casablanca 20250
Phone +212 2 343700
Fax +212 2 343699
- MAL Malaysia**
Please contact
Weidmüller Singapore
- MEX Mexico**
W Interconnections, S.A. de C.V.
Av. Ingenieros Civiles No. 204-B,
Conjunto Industrial Chachapa
72990 Chachapa,
Puebla Mexico
Phone +52 222 2866247/48/49
Fax +52 222 2866242
clientes@weidmuller.com.mx

- MK Macedonia**
ES MK Elektrosistem d.o.o.
Ul. Bulevar III makedonske brigade bb
91000 Skoplje
Macedonia
Phone +389 91 460295
Fax +389 91 460298
elektrosistem-mk@mt.net.mk
- N Norway**
Siv. Ing. J. F. Knudtzen A/S
Billingstadsletta 97
1396 Billingstad
P.O. Box 160
1378 Nesbru
Phone +47 66 983350
Fax +47 66 980955
patorgersbraaten@jfknudtzen.no
- NIC Nicaragua**
Please contact
ELVATRON S. A., Costa Rica
- NL Netherlands**
Weidmüller Benelux B.V.
Franciscusweg 221
1216 SE Hilversum
Postbus 1505
1200 BM Hilversum
Phone +31 35 6261261
Fax +31 35 6234569
info@weidmuller.nl
www.weidmuller.nl
- NZ New Zealand**
Cuthbert S. Steward Limited
27 Te Puni Street
POB 38496 Petone
Petone, Wellington
Phone +64 4 5686156
Fax +64 4 5686056
- OM Oman**
Please contact
Weidmüller Middle East
United Arab Emirates
- P Portugal**
Weidmüller - Sistemas de Interface, S. A.
Estrada Outeiro Polima, Lote B,
N° B2, Escritório 2 - Abóboda
2785-518 Sao Domingos de Rana
Lisboa
Phone +351 21 4459190
Fax +351 21 4455871
weidmuller@weidmuller.pt
www.weidmuller.pt
- PA Panama**
Please contact
ELVATRON S. A., Costa Rica
- PE Peru**
DIN AUTOMATIZACION S. A.
Rimac Pampa 385 - Maranga
Lima 32
Phone +51 1 4511733
Fax +51 1 4491095
mail@dinaut.com
- PK Pakistan**
Access Technology Networks
[Pvt] Ltd.
Flat 1, 2nd Floor, Panther Plaza
16B, F8, MARKAZ
Islamabad
Pakistan
Phone +92 51 2254371-72
Fax +92 51 2261086
atn@isb.comsats.net.pk
- PL Poland**
Weidmüller Sp. z o.o.
ul. Goleđzinowska 10
03-302 Warszawa
Poland
Phone +48 22 5100940
Fax +48 22 5100941
biuro@weidmuller.com.pl
www.weidmuller.pl
- PY Paraguay**
Rewo Paraguay S.A.
Sucre 2590 esq Emeterio Miranda
Asunción
Paraguay
Phone +595 21 60 60 13
Fax +595 21 60 60 13
rewo@telesurf.com.py
- Q Qatar**
Please contact
Weidmüller Middle East
United Arab Emirates
- RA Argentina**
CPI SA
Bauness 2660
1431 Buenos Aires
Phone +54 11 45238008
Fax +54 11 45220546
compras@cpi.com.ar
- RC Taiwan**
Fittatek Corp., Ltd.
12 F No. 185 Fu-Kuo Rd,
Tso Ying Dist,
Kaohsiung, Taiwan R.O.C.
Phone +886 7556-0858
Fax +886 7556-3279
- RCH Chile**
Felipe Bahamondes S.A./ATS AGRO
Servicios Agroindustriales
María Luisa Santander 0475
Providencia
Casilla 3425
Santiago
Phone +56 2 341-1271
Fax +56 2 341-1275
felipe@mailblocks.com
- RI Indonesia**
P. T. Nego Electrindo
Komplek Perkantoran Kramat Centre
Blok-A 18 Jl Kramat Raya No. 7-9
Jakarta 10450
Phone +62 21 3156218
Fax +62 21 3156219
- RL Libanon**
Progress Engineering & Trading
Enterprises
P.O. Box 11-1111
Pharaon Bldg., Opp Electr. du Liban
Chafaca Str., Al Nahr
Beirut - Libanon
Phone +961 144 4664
Fax +961 144 4664
progress@inco.com.lb
- RO Romania**
ROMINTERFACE IMPEX SRL
Splaiul Unirii nr. 45, Bl. M 15
sc. 3, ap. 68-69, Sect. 3
74342 Bucuresti
Phone +40 1 3220230
Fax +40 1 3228857
romint@dnt.ro
- ROK South Korea**
Weidmüller Co., Ltd.
2 floor Wooam B/D 46-27
Samsung2-Dong, Kangnam-Ku
Seoul
Korea, Zip: 135-868
Phone +82 2 5160003
Fax +82 2 5160090
info@weidmuller.co.kr
- RP Philippines**
Tradepoints, Inc.
3rd Floor PM Santiago Bldg.
5081 P. Burgos Cor.,
San Mateo Streets
Makati Manila
Phone +63 2 8993294
Fax +63 2 8993306
- RUS Russia**
Weidmüller Representative office
Shabolovka street 2
119049 Russia, Moskau
Phone +7 095 771-6940
Fax +7 095 771-6941
info@weidmueller.ru
www.weidmueller.ru
- S Sweden**
Weidmüller AB
Stockholm, Arenavägen 39,
12177 Johanneshov
P.O. Box 10120
12128 Stockholm-Globen
Phone +46 771 43 00 44
Fax +46 8 7272480
mail.stockholm@weidmuller.se
- SA Saudi Arabia**
Al Abdulkarim Trading
P.O. Box 5777, Dammam
31432 Saudi Arabia
Phone +966 3 833-7110
Fax +966 3 833-8242
info@akte.com.sa
- SA Saudi Arabia**
Saudi Electric Supply Co.
P.O. Box 3298, Al Khobar
31952 Saudi Arabia
Phone +966 3 882-9546227
Fax +966 3 882-9547
customer.service@sesco-ge.com
- SGP Singapore**
Weidmüller Pte. Ltd.
Cititech Building
629 Aljunied Road #05-05
Singapore 389838
Phone +65 6841 5311
Fax +65 6841 5377
sales@weidmuller.com.sg
www.weidmuller.com.sg
- SK Slovakia**
Elektris s.r.o.
Racianska 188
SK 83153 Bratislava, Slovakia
Phone +421 2 4920013
Fax +421 2 44680328
weidmueller@computel.sk
- SLO Slovenia**
ELEKTROSPOLJ d.o.o.
Stegne 25
1000 Ljubljana
Phone +38 6 15113810
Fax +38 6 15111604
elektrospolj@siol.net
- SYR Syria**
Please contact
Weidmüller Middle East,
United Arab Emirates
- T Thailand**
Pisanu Engineering &
Construction Co. Ltd.
800/2 Asoke-Dindaeng
Road Dindaeng
Bangkok 10400
Phone +66 2 2459113
Fax +66 2 2463214
pisanu@kanit.co.th
- TR Turkey**
Weidmüller Elektronik Ticaret Ltd.
Sirketi
Kore Sehilleri Cad. 34/1-7
80300 Zincirlikuyu – Istanbul
Phone +90 212 2730830
Fax +90 212 2740874
info@weidmuller.com.tr
- UA Ukraine**
TEKO Interface
Per.Industrialny 2
03056 - Kiev
Phone +380 04463 57760
Fax +380 04463 91082
elektro@panko.kiev.ua
- UAE U.A.E. United Arab Emirates**
Weidmüller Middle-East
P.O. Box 62448
Dubai
Phone +971 4 3522215, 3523043
Fax +971 4 3599950
- USA USA**
W-Interconnections, Inc.
821 Southlake Boulevard,
Richmond, VA 23236
Phone +1 804 7942877
Fax +1 804 3792593
info@weidmuller.com
www.weidmuller.com
- VN Vietnam**
Thien Nghi Trading Pte
60B Tan Da Street
District 5 Ho Chi Min
Phone +84 8 8555387
Fax +84 8 8549304
- YU Serbia and Montenegro**
ES YU Elektrosistem d.o.o.
ul. Pariske komune 41
11070 Novi Beograd
Serbia
Phone +381 11 697212, 693608
Fax +381 11 697212, 693608
esyu@infosky.net
www.elektrosistem.co.yu
- Y Venezuela**
Somerinca C. A.
Edificio Esteban Piso 2
Calle Vargas Bolleita Notre
Caracas 1070 A
Venezuela
Phone +58 212 2352748
Fax +58 212 2385625
hcastrog@somerincayv.com
- ZA South Africa**
RAD Interface Pty. Ltd.
5 Bundo Road
Sebenza Extension
Edenvale 1609
P.O.Box 193
Edenvale 1610
Phone +27 11 452-1930
Fax +27 11 452-6455
alockyer@radinterface.co.za

A Group companies

A Agency abroad

A Without own Agency

We cannot guarantee that there are no mistakes in the publications or software provided by us to the customer for the purpose of making orders.

We try our best to correct any fault as soon as it is located. For this purpose we make all corrections, which have been made after publishing a catalogue, available on our website at www.weidmueller.com. For your convenience we list order no. and catalogue page along.

This Internet-database is part of our catalogue.

All orders are based on our general terms of delivery, which can be reviewed on the websites of our group companies where you placed your order. On demand we can also send the general terms of delivery to you.

www.weidmueller.com

Argentina	Indonesia	Saudi Arabia
Australia	Iran	Serbia/
Austria	Ireland	Montenegro
Bahrain	Israel	Singapore
Belarus	Italy	Slovakia
Belgium	Japan	Slovenia
Bosnia- Herzegovina	Jordan	South Africa
Brazil	Kuwait	South Korea
Bulgaria	Latvia	Spain
Canada	Lebanon	Sweden
Chile	Lithuania	Switzerland
China	Luxembourg	Syria
Colombia	Macedonia	Taiwan
Costa Rica	Malaysia	Thailand
Croatia	Morocco	Turkey
Czech Republic	Mexico	Ukraine
Denmark	Netherlands	United Arab
Egypt	New Zealand	Emirates
El Salvador	Nicaragua	United Kingdom
Estonia	Norway	USA
Finland	Oman	Venezuela
France	Pakistan	Vietnam
Germany	Panama	Yemen
Greece	Paraguay	
Guatemala	Peru	
Honduras	Philippines	
Hong Kong	Poland	
Hungary	Portugal	
Iceland	Qatar	
India	Romania	
	Russia	

Weidmüller is the leading manufacturer of components for electrical connection technology. The Weidmüller product portfolio ranges from terminal blocks, PCB connectors and terminals, protected components and relay sockets to power supply and overvoltage protection modules suitable for all applications. Electrical installation and marking material, basic I/O components and a variety of tools round off the range. As an OEM supplier, the company sets global standards in the field of electrical connection technology.

Order number:
5649270000/03/2005/DMMD

