

MMFT2406T1

Preferred Device

Power MOSFET 700 mA, 240 Volts N-Channel SOT-223

This Power MOSFET is designed for high speed, low loss power switching applications such as switching regulators, converters, solenoid and relay drivers. The device is housed in the SOT-223 package which is designed for medium power surface mount applications.

- Silicon Gate for Fast Switching Speeds
- High Voltage – 240 Vdc
- Low Drive Requirement
- The SOT-223 Package can be soldered using wave or reflow. The formed leads absorb thermal stress during soldering, eliminating the possibility of damage to the die.

MAXIMUM RATINGS (T_C = 25°C unless otherwise noted)

Rating	Symbol	Value	Unit
Drain-to-Source Voltage	V _{DS}	240	Vdc
Gate-to-Source Voltage – Continuous	V _{GS}	±20	Vdc
Drain Current	I _D	700	mA _{dc}
Total Power Dissipation @ T _A = 25°C (Note 1.) Derate above 25°C	P _D	1.5 12	Watts mW/°C
Operating and Storage Temperature Range	T _J , T _{stg}	-65 to 150	°C

THERMAL CHARACTERISTICS

Thermal Resistance – Junction-to-Ambient (surface mounted) (Note 1.)	R _{θJA}	83.3	°C/W
Lead Temperature for Soldering Purposes, 1/16" from case Time in Solder Bath	T _L	260 10	°C Sec

1. Device mounted on a glass epoxy printed circuit board 1.575 in. x 1.575 in. x 0.059 in.; mounting pad for the collector lead min. 0.93 sq. in.



ON Semiconductor™

<http://onsemi.com>

700 mA
240 VOLTS
RDS(on) = 6.0 Ω

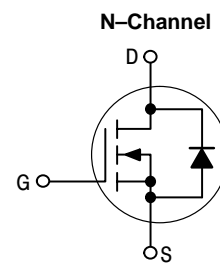

MARKING DIAGRAM

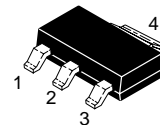

TO-261AA
CASE 318E
STYLE 3

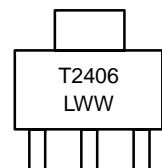

L = Location Code
WW = Work Week

PIN ASSIGNMENT

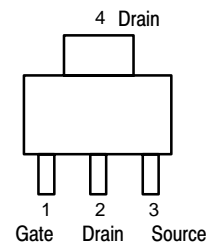

ORDERING INFORMATION

Device	Package	Shipping
MMFT2406T1	SOT-223	1000 Tape & Reel
MMFT2406T3	SOT-223	4000 Tape & Reel

Preferred devices are recommended choices for future use and best overall value.

MMFT2406T1

ELECTRICAL CHARACTERISTICS (T_A = 25°C unless otherwise noted)

Characteristics	Symbol	Min	Max	Unit
-----------------	--------	-----	-----	------

OFF CHARACTERISTICS

Drain-to-Source Breakdown Voltage (V _{GS} = 0, I _D = 100 μA)	V _{(BR)DSS}	240	–	Vdc
Zero Gate Voltage Drain Current (V _{DS} = 120 V, V _{GS} = 0)	I _{DSS}	–	10	μAdc
Gate-Body Leakage Current (V _{GS} = 15 Vdc, V _{DS} = 0)	I _{GSS}	–	100	nAdc

ON CHARACTERISTICS (Note 2.)

Gate Threshold Voltage (V _{DS} = V _{GS} , I _D = 1.0 mAdc)	V _{GS(th)}	0.8	2.0	Vdc
Static Drain-to-Source On-Resistance (V _{GS} = 2.5 Vdc, I _D = 0.1 Adc) (V _{GS} = 10 Vdc, I _D = 0.5 Adc)	R _{DS(on)}	– –	10 6.0	Ohms
Drain-to-Source On-Voltage (V _{GS} = 10 V, I _D = 0.5 A)	V _{DS(on)}	–	3.0	Vdc
Forward Transconductance (V _{DS} = 6.0 V, I _D = 0.5 A)	g _{FS}	300	–	mmhos

DYNAMIC CHARACTERISTICS

Input Capacitance	(V _{DS} = 25 V, V _{GS} = 0, f = 1.0 MHz)	C _{iss}	–	125	pF
Output Capacitance		C _{oss}	–	50	
Transfer Capacitance		C _{rss}	–	20	

2. Pulse Test: Pulse Width ≤ 300 μs, Duty Cycle ≤ 2.0%.

INFORMATION FOR USING THE SOT-223 SURFACE MOUNT PACKAGE

MINIMUM RECOMMENDED FOOTPRINT FOR SURFACE MOUNTED APPLICATIONS

Surface mount board layout is a critical portion of the total design. The footprint for the semiconductor packages must be the correct size to insure proper solder connection

interface between the board and the package. With the correct pad geometry, the packages will self align when subjected to a solder reflow process.

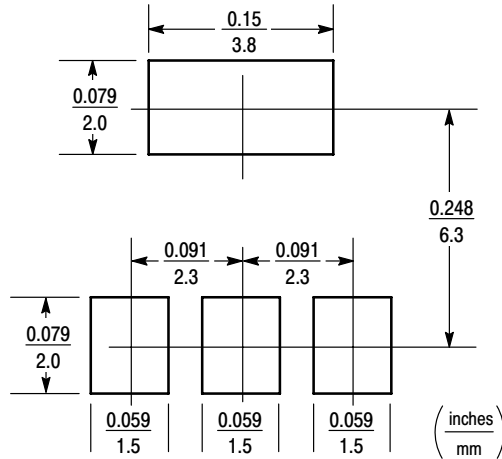

SOT-223 POWER DISSIPATION

The power dissipation of the SOT-223 is a function of the pad size. This can vary from the minimum pad size for soldering to a pad size given for maximum power dissipation. Power dissipation for a surface mount device is determined by $T_{J(max)}$, the maximum rated junction temperature of the die, $R_{\theta JA}$, the thermal resistance from the device junction to ambient, and the operating temperature, T_A . Using the values provided on the data sheet for the SOT-223 package, P_D can be calculated as follows:

$$P_D = \frac{T_{J(max)} - T_A}{R_{\theta JA}}$$

The values for the equation are found in the maximum ratings table on the data sheet. Substituting these values into the equation for an ambient temperature T_A of 25°C, one can calculate the power dissipation of the device which in this case is 1.5 watts.

$$P_D = \frac{150^\circ\text{C} - 25^\circ\text{C}}{83.3^\circ\text{C/W}} = 1.5 \text{ watts}$$

The 83.3°C/W for the SOT-223 package assumes the use of the recommended footprint on a glass epoxy printed circuit board to achieve a power dissipation of 1.5 watts. There are other alternatives to achieving higher power dissipation from the SOT-223 package. One is to increase the area of the collector pad. By increasing the area of the collector pad, the power dissipation can be increased. Although the power dissipation can almost be doubled with this method, area is taken up on the printed circuit board which can defeat the purpose of using surface mount technology. A graph of $R_{\theta JA}$ versus collector pad area is shown in Figure 1.

MMFT2406T1

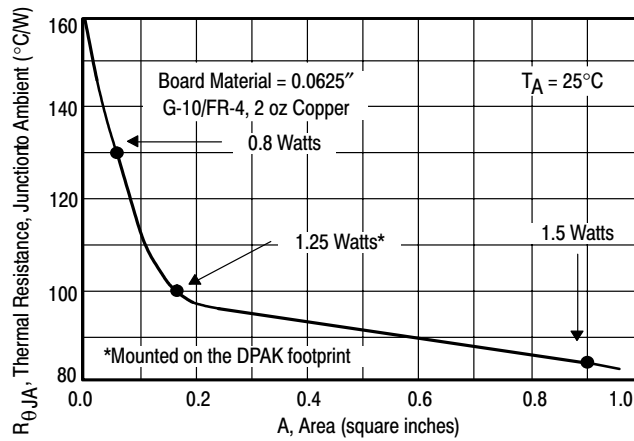

Figure 1. Thermal Resistance versus Collector Pad Area for the SOT-223 Package (Typical)

Another alternative would be to use a ceramic substrate or an aluminum core board such as Thermal Clad™. Using a board material such as Thermal Clad, an aluminum core

board, the power dissipation can be doubled using the same footprint.

SOLDER STENCIL GUIDELINES

Prior to placing surface mount components onto a printed circuit board, solder paste must be applied to the pads. A solder stencil is required to screen the optimum amount of solder paste onto the footprint. The stencil is made of brass

or stainless steel with a typical thickness of 0.008 inches. The stencil opening size for the SOT-223 package should be the same as the pad size on the printed circuit board, i.e., a 1:1 registration.

SOLDERING PRECAUTIONS

The melting temperature of solder is higher than the rated temperature of the device. When the entire device is heated to a high temperature, failure to complete soldering within a short time could result in device failure. Therefore, the following items should always be observed in order to minimize the thermal stress to which the devices are subjected.

- Always preheat the device.
- The delta temperature between the preheat and soldering should be 100°C or less.*
- When preheating and soldering, the temperature of the leads and the case must not exceed the maximum temperature ratings as shown on the data sheet. When using infrared heating with the reflow soldering method, the difference should be a maximum of 10°C.

- The soldering temperature and time should not exceed 260°C for more than 10 seconds.
- When shifting from preheating to soldering, the maximum temperature gradient should be 5°C or less.
- After soldering has been completed, the device should be allowed to cool naturally for at least three minutes. Gradual cooling should be used as the use of forced cooling will increase the temperature gradient and result in latent failure due to mechanical stress.
- Mechanical stress or shock should not be applied during cooling

* Soldering a device without preheating can cause excessive thermal shock and stress which can result in damage to the device.

TYPICAL SOLDER HEATING PROFILE

For any given circuit board, there will be a group of control settings that will give the desired heat pattern. The operator must set temperatures for several heating zones, and a figure for belt speed. Taken together, these control settings make up a heating “profile” for that particular circuit board. On machines controlled by a computer, the computer remembers these profiles from one operating session to the next. Figure 2 shows a typical heating profile for use when soldering a surface mount device to a printed circuit board. This profile will vary among soldering systems but it is a good starting point. Factors that can affect the profile include the type of soldering system in use, density and types of components on the board, type of solder used, and the type of board or substrate material being used. This profile shows temperature versus time.

The line on the graph shows the actual temperature that might be experienced on the surface of a test board at or near a central solder joint. The two profiles are based on a high density and a low density board. The Vitronics SMD310 convection/infrared reflow soldering system was used to generate this profile. The type of solder used was 62/36/2 Tin Lead Silver with a melting point between 177–189°C. When this type of furnace is used for solder reflow work, the circuit boards and solder joints tend to heat first. The components on the board are then heated by conduction. The circuit board, because it has a large surface area, absorbs the thermal energy more efficiently, then distributes this energy to the components. Because of this effect, the main body of a component may be up to 30 degrees cooler than the adjacent solder joints.

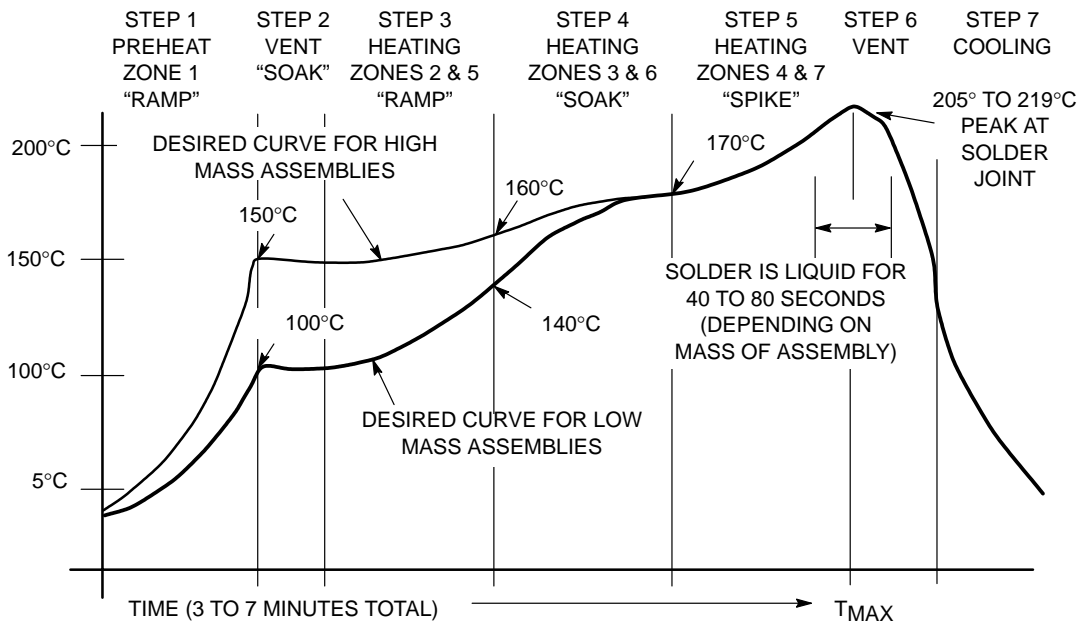

Figure 2. Typical Solder Heating Profile

MMFT2406T1

PACKAGE DIMENSIONS

SOT-223 (TO-261)

CASE 318E-04

ISSUE K

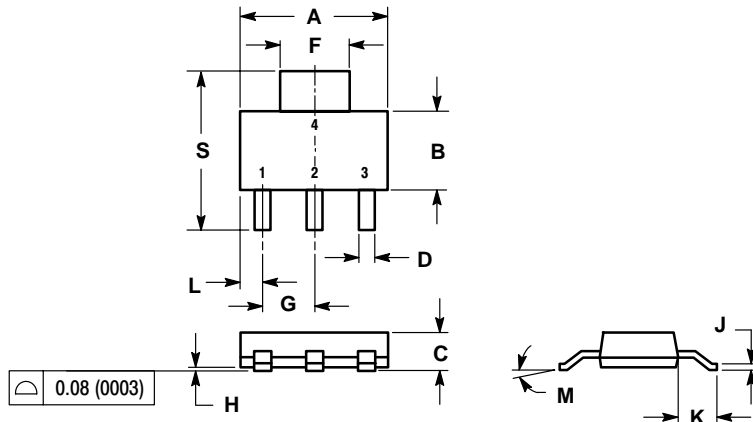

NOTES:

1. DIMENSIONING AND TOLERANCING PER ANSI Y14.5M, 1982.
2. CONTROLLING DIMENSION: INCH.

DIM	INCHES		MILLIMETERS	
	MIN	MAX	MIN	MAX
A	0.249	0.263	6.30	6.70
B	0.130	0.145	3.30	3.70
C	0.060	0.068	1.50	1.75
D	0.024	0.035	0.60	0.89
F	0.115	0.126	2.90	3.20
G	0.087	0.094	2.20	2.40
H	0.0008	0.0040	0.020	0.100
J	0.009	0.014	0.24	0.35
K	0.060	0.078	1.50	2.00
L	0.033	0.041	0.85	1.05
M	0°	10°	0°	10°
S	0.264	0.287	6.70	7.30

STYLE 3:

- PIN 1. GATE
 2. DRAIN
 3. SOURCE
 4. DRAIN

Notes

Thermal Clad is a registered trademark of the Bergquist Company.

ON Semiconductor and  are trademarks of Semiconductor Components Industries, LLC (SCILLC). SCILLC reserves the right to make changes without further notice to any products herein. SCILLC makes no warranty, representation or guarantee regarding the suitability of its products for any particular purpose, nor does SCILLC assume any liability arising out of the application or use of any product or circuit, and specifically disclaims any and all liability, including without limitation special, consequential or incidental damages. "Typical" parameters which may be provided in SCILLC data sheets and/or specifications can and do vary in different applications and actual performance may vary over time. All operating parameters, including "Typicals" must be validated for each customer application by customer's technical experts. SCILLC does not convey any license under its patent rights nor the rights of others. SCILLC products are not designed, intended, or authorized for use as components in systems intended for surgical implant into the body, or other applications intended to support or sustain life, or for any other application in which the failure of the SCILLC product could create a situation where personal injury or death may occur. Should Buyer purchase or use SCILLC products for any such unintended or unauthorized application, Buyer shall indemnify and hold SCILLC and its officers, employees, subsidiaries, affiliates, and distributors harmless against all claims, costs, damages, and expenses, and reasonable attorney fees arising out of, directly or indirectly, any claim of personal injury or death associated with such unintended or unauthorized use, even if such claim alleges that SCILLC was negligent regarding the design or manufacture of the part. SCILLC is an Equal Opportunity/Affirmative Action Employer.

PUBLICATION ORDERING INFORMATION

NORTH AMERICA Literature Fulfillment:

Literature Distribution Center for ON Semiconductor
P.O. Box 5163, Denver, Colorado 80217 USA
Phone: 303-675-2175 or 800-344-3860 Toll Free USA/Canada
Fax: 303-675-2176 or 800-344-3867 Toll Free USA/Canada
Email: ONlit@hibbertco.com
Fax Response Line: 303-675-2167 or 800-344-3810 Toll Free USA/Canada

N. American Technical Support: 800-282-9855 Toll Free USA/Canada

EUROPE: LDC for ON Semiconductor – European Support

German Phone: (+1) 303-308-7140 (Mon-Fri 2:30pm to 7:00pm CET)
Email: ONlit-german@hibbertco.com
French Phone: (+1) 303-308-7141 (Mon-Fri 2:00pm to 7:00pm CET)
Email: ONlit-french@hibbertco.com
English Phone: (+1) 303-308-7142 (Mon-Fri 12:00pm to 5:00pm GMT)
Email: ONlit@hibbertco.com

EUROPEAN TOLL-FREE ACCESS*: 00-800-4422-3781

*Available from Germany, France, Italy, UK, Ireland

CENTRAL/SOUTH AMERICA:

Spanish Phone: 303-308-7143 (Mon-Fri 8:00am to 5:00pm MST)
Email: ONlit-spanish@hibbertco.com
Toll-Free from Mexico: Dial 01-800-288-2872 for Access –
then Dial 866-297-9322

ASIA/PACIFIC: LDC for ON Semiconductor – Asia Support

Phone: 303-675-2121 (Tue-Fri 9:00am to 1:00pm, Hong Kong Time)
Toll Free from Hong Kong & Singapore:
001-800-4422-3781
Email: ONlit-asia@hibbertco.com

JAPAN: ON Semiconductor, Japan Customer Focus Center
4-32-1 Nishi-Gotanda, Shinagawa-ku, Tokyo, Japan 141-0031
Phone: 81-3-5740-2700
Email: r14525@onsemi.com

ON Semiconductor Website: <http://onsemi.com>

For additional information, please contact your local Sales Representative.