

MBRP30045CT

Preferred Device

POWERTAP™ II SWITCHMODE™ Power Rectifier

... using the Schottky Barrier principle with a platinum barrier metal. These state-of-the-art devices have the following features:

- Dual Diode Construction —
May Be Paralleled for Higher Current Output
- Guardring for Stress Protection
- Low Forward Voltage
- 150°C Operating Junction Temperature
- Guaranteed Reverse Avalanche

Mechanical Characteristics:

- Case: Epoxy, Molded with metal heatsink base
- Weight: 80 grams (approximately)
- Finish: All External Surfaces Corrosion Resistant
- Top Terminal Torque: 25-40 lb-in max
- Base Plate Torques:
See procedure given in the Package Outline Section
- Shipped 25 units per foam
- Marking: B30045T

MAXIMUM RATINGS

Rating	Symbol	Max	Unit
Peak Repetitive Reverse Voltage Working Peak Reverse Voltage DC Blocking Voltage	V_{RRM} V_{RWM} V_R	45	V
Average Rectified Forward Current (Rated V_R , $T_C = 140^\circ\text{C}$) Per Leg Per Device	$I_{F(AV)}$	150 300	A
Peak Repetitive Forward Current, (Rated V_R , Square Wave, 20 kHz, $T_C = 140^\circ\text{C}$) Per Leg	I_{FRM}	300	A
Non-Repetitive Peak Surge Current (Surge Applied at Rated Load Conditions Halfwave, Single Phase, 60 Hz) Per Leg	I_{FSM}	2500	A
Peak Repetitive Reverse Current (2.0 μs , 1.0 kHz) Per Leg	I_{RRM}	2.0	A
Storage Temperature Range	T_{stg}	-55 to +150	$^\circ\text{C}$
Operating Junction Temperature	T_J	-55 to +150	$^\circ\text{C}$
Voltage Rate of Change (Rated V_R)	dv/dt	10,000	$\text{V}/\mu\text{s}$



ON Semiconductor®

<http://onsemi.com>

**SCHOTTKY
BARRIER RECTIFIER
300 AMPERES
45 VOLTS**

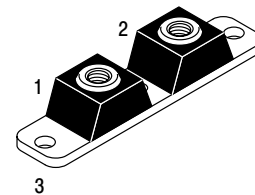
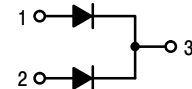

POWERTAP II
CASE 357C
PLASTIC

MARKING DIAGRAM

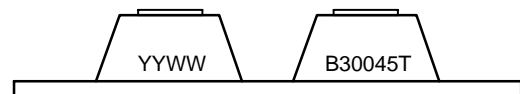

B30045T = Device Code
YY = Year
WW = Work Week

ORDERING INFORMATION

Device	Package	Shipping
MBRP30045CT	POWERTAP II	25 Units/Tray

Preferred devices are recommended choices for future use and best overall value.

MBRP30045CT

THERMAL CHARACTERISTICS (Per Leg)

Rating	Symbol	Value	Unit
Thermal Resistance, Junction to Case	$R_{\theta JC}$	0.45	°C/W

ELECTRICAL CHARACTERISTICS (Per Leg)

Instantaneous Forward Voltage (Note 1) ($i_F = 150$ Amps, $T_J = 25^\circ\text{C}$) ($i_F = 300$ Amps, $T_J = 25^\circ\text{C}$)	V_F	0.70 0.82	Volts
Instantaneous Reverse Current (Note 1) (Rated dc Voltage, $T_J = 125^\circ\text{C}$) (Rated dc Voltage, $T_J = 25^\circ\text{C}$)	i_R	75 0.8	mA

1. Pulse Test: Pulse Width = 300 μs , Duty Cycle $\leq 2.0\%$.

MAXIMUM MECHANICAL RATINGS

Terminal Penetration:	0.235 max
Terminal Torque:	25-40 in-lb max
Mounting Torque — Outside Holes:	30-40 in-lb max
Mounting Torque — Center Hole:	8-10 in-lb max
Seating Plane Flatness	1 mil per in. (between mounting holes)

POWERTAP MECHANICAL DATA APPLIES OVER OPERATING TEMPERATURE

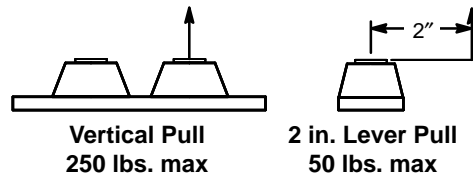

Note: While the POWERTAP is capable of sustaining these vertical and levered tensions, the intimate contact between POWERTAP and heat sink may be lost. This could lead to thermal runaway. The use of very flexible leads is recommended for the anode connections. Use of thermal grease is highly recommended.

MBRP30045CT

MOUNTING PROCEDURE

The POWERTAP package requires special mounting considerations because of the long longitudinal axis of the copper heat sink. It is important to follow the proper tightening sequence to avoid warping the heat sink, which can reduce thermal contact between the POWERTAP and heat sink.

STEP 1:

Locate the POWERTAP on the heat sink and start mounting bolts into the threads by hand (2 or 3 turns).

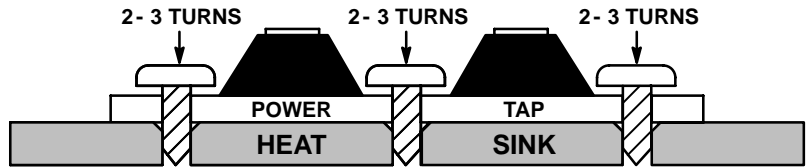

STEP 2:

Finger tighten the center bolt. The bolt may catch on the threads of the heat sink so it is important to make sure the face of the bolt or washer is in contact with the surface of the POWERTAP.

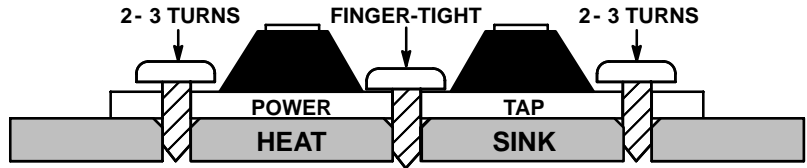

STEP 3:

Tighten each of the end bolts between 5 to 10 in-lb.

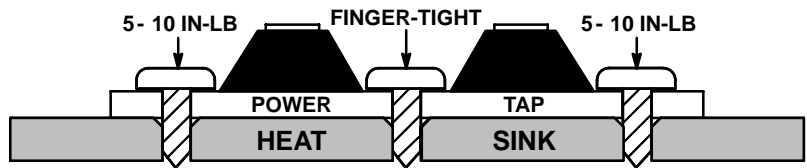

STEP 4:

Tighten the center bolt between 8 to 10 in-lb.

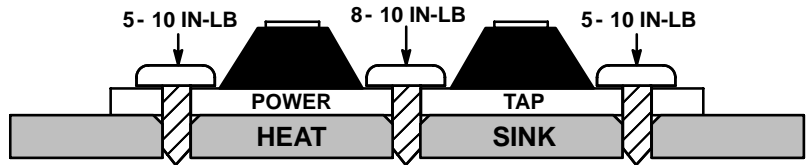

STEP 5:

Finally, tighten the end bolts between 30 to 40 in-lb.

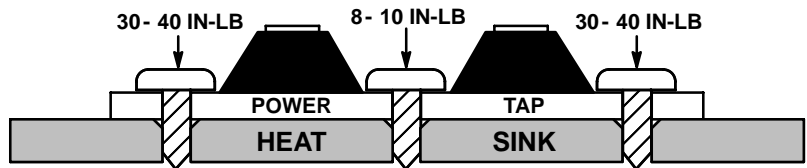

MBRP30045CT

PACKAGE DIMENSIONS

CASE 357C-03
 POWERTAP
 PLASTIC PACKAGE
 ISSUE E

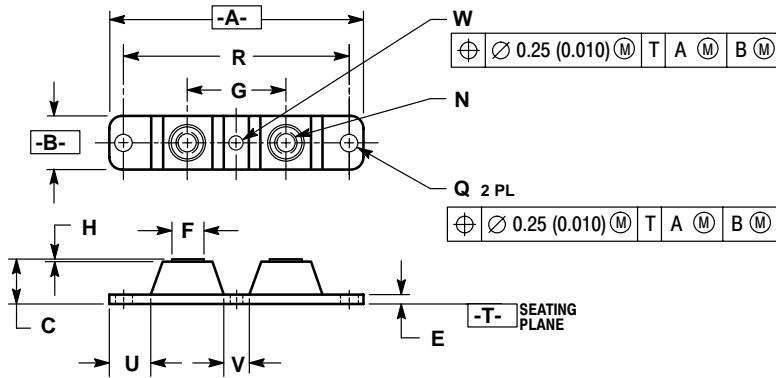

NOTES:

1. DIMENSIONING AND TOLERANCING PER ANSI Y14.5M, 1982.
2. CONTROLLING DIMENSION: INCH.
3. TERMINAL PENETRATION: 5.97 (0.235) MAXIMUM.

DIM	INCHES		MILLIMETERS	
	MIN	MAX	MIN	MAX
A	3.450	3.635	87.63	92.33
B	0.700	0.810	17.78	20.57
C	0.615	0.640	15.63	16.26
E	0.120	0.130	3.05	3.30
F	0.435	0.445	11.05	11.30
G	1.370	1.380	34.80	35.05
H	0.007	0.030	0.18	0.76
N	1/4-20UNC-2B		1/4-20UNC-2B	
Q	0.270	0.285	6.86	7.23
R	.3150 BSC		.8001 BSC	
U	0.600	0.630	15.24	16.00
V	0.330	0.375	8.39	9.52
W	0.170	0.190	4.32	4.82

POWERTAP and SWITCHMODE are trademarks of Semiconductor Components Industries, LLC

ON Semiconductor and  are registered trademarks of Semiconductor Components Industries, LLC (SCILLC). SCILLC reserves the right to make changes without further notice to any products herein. SCILLC makes no warranty, representation or guarantee regarding the suitability of its products for any particular purpose, nor does SCILLC assume any liability arising out of the application or use of any product or circuit, and specifically disclaims any and all liability, including without limitation special, consequential or incidental damages. "Typical" parameters which may be provided in SCILLC data sheets and/or specifications can and do vary in different applications and actual performance may vary over time. All operating parameters, including "Typicals" must be validated for each customer application by customer's technical experts. SCILLC does not convey any license under its patent rights nor the rights of others. SCILLC products are not designed, intended, or authorized for use as components in systems intended for surgical implant into the body, or other applications intended to support or sustain life, or for any other application in which the failure of the SCILLC product could create a situation where personal injury or death may occur. Should Buyer purchase or use SCILLC products for any such unintended or unauthorized application, Buyer shall indemnify and hold SCILLC and its officers, employees, subsidiaries, affiliates, and distributors harmless against all claims, costs, damages, and expenses, and reasonable attorney fees arising out of, directly or indirectly, any claim of personal injury or death associated with such unintended or unauthorized use, even if such claim alleges that SCILLC was negligent regarding the design or manufacture of the part. SCILLC is an Equal Opportunity/Affirmative Action Employer.

PUBLICATION ORDERING INFORMATION

Literature Fulfillment:

Literature Distribution Center for ON Semiconductor
 P.O. Box 5163, Denver, Colorado 80217 USA
Phone: 303-675-2175 or 800-344-3860 Toll Free USA/Canada
Fax: 303-675-2176 or 800-344-3867 Toll Free USA/Canada
Email: ONlit@hibbertco.com

N. American Technical Support: 800-282-9855 Toll Free USA/Canada

JAPAN: ON Semiconductor, Japan Customer Focus Center
 2-9-1 Kamimeguro, Meguro-ku, Tokyo, Japan 153-0051
Phone: 81-3-5773-3850
Email: r14525@onsemi.com

ON Semiconductor Website: <http://onsemi.com>

For additional information, please contact your local Sales Representative.