



### Applications

- Low voltage, high density systems with Intermediate Bus Architectures (IBA)
- Point-of-load regulators for high performance DSP, FPGA, ASIC, and microprocessor applications
- Desktops, servers, and portable computing
- Broadband, networking, optical, and communications systems
- Active memory bus terminators

### Benefits

- Integrates digital power conversion with intelligent power management
- Eliminates the need for external power management components
- Completely programmable via industry-standard I<sup>2</sup>C communication bus
- One part that covers all applications
- Reduces board space, system cost and complexity, and time to market

### Description

The ZY7010L is an intelligent, fully programmable step-down point-of-load DC-DC module integrating digital power conversion and intelligent power management. When used with ZM7000 Series Digital Power Managers, the ZY7010L completely eliminates the need for external components for sequencing, tracking, protection, monitoring, and reporting. All parameters of the ZY7010L are programmable via the industry-standard I<sup>2</sup>C communication bus and can be changed by a user at any time during product development and service.

### Features

- RoHS lead free and lead-solder-exempt products are available
- Wide input voltage range: 3V–13.2V
- High continuous output current: 10A
- Wide programmable output voltage range: 0.5V–5.5V
- Active digital current share
- Single-wire serial communication bus for frequency synchronization, programming, and monitoring
- Optimal voltage positioning with programmable slope of the VI line
- Overcurrent, overvoltage, undervoltage, and overtemperature protections with programmable thresholds and types
- Programmable fixed switching frequency 0.5-1.0MHz
- Programmable turn-on and turn-off delays
- Programmable turn-on and turn-off voltage slew rates with tracking protection
- Programmable feedback loop compensation
- Power Good signal with programmable limits
- Programmable fault management
- Start up into the load pre-biased up to 100%
- Full rated current sink
- Real time voltage, current, and temperature measurements, monitoring, and reporting
- Small footprint SMT package: 16x32mm
- Extremely low profile of 7mm
- Compatible with conventional pick-and-place equipment
- Wide operating temperature range
- UL60950 recognized, CSA C22.2 No. 60950-00 certified, and TUV EN60950-1:2001 certified

### Reference Documents:

- ZM7XXX Digital Power Manager. Data Sheet
- ZM7XXX Digital Power Manager. Programming Manual
- Z-One® Graphical User Interface
- ZM00056-KIT USB to I<sup>2</sup>C Adapter Kit. User Manual

### 1. Ordering Information

ZY	70	10	L	y	-	zz
<b>Product family:</b> Z-One Module	<b>Series:</b> Intelligent POL Converter	<b>Output Current:</b> 10A	<b>Output voltage setpoint accuracy:</b> L – 1.2% or 20mV, whichever is greater	<b>RoHS compliance:</b> <b>No suffix</b> - RoHS compliant with Pb solder exemption <sup>1</sup> <b>G</b> - RoHS compliant for all six substances	<b>Dash</b>	<b>Packaging Option<sup>2</sup>:</b> T1 – 500pcs T&R T2 – 100pcs T&R T3 – 50pcs T&R Q1 – 1pc sample for evaluation only

<sup>1</sup> The solder exemption refers to all the restricted materials except lead in solder. These materials are Cadmium (Cd), Hexavalent chromium (Cr6+), Mercury (Hg), Polybrominated biphenyls (PBB), Polybrominated diphenylethers (PBDE), and Lead (Pb) used anywhere except in solder.

<sup>2</sup> Packaging option is used only for ordering and not included in the part number printed on the POL converter label.

<sup>3</sup> The evaluation board is available in only one configuration: ZM7300-KIT-HKS.

Example: **ZY7010LG-T2**: A 100-piece reel of RoHS compliant POL converters with the output voltage setpoint of 1.0% or 20mV, whichever is greater. Each POL converter is labeled ZY7010LG.

### 2. Absolute Maximum Ratings

Stresses in excess of the absolute maximum ratings may cause performance degradation, adversely affect long-term reliability, and cause permanent damage to the converter.

Parameter	Conditions/Description	Min	Max	Units
Operating Temperature	Controller case temperature	-40	105	°C
Input Voltage	250ms Transient		15	VDC
Output Current	(See Output Current Derating Curves)	-10	10	ADC

### 3. Environmental and Mechanical Specifications

Parameter	Conditions/Description	Min	Nom	Max	Units
Ambient Temperature Range		-40		85	°C
Storage Temperature (Ts)		-55		125	°C
Weight				15	grams
MTBF	Calculated Per Telcordia Technologies SR-332	3.11			MHrs
Peak Reflow Temperature	ZY7010L			220	°C
	ZY7010LG		245	260	°C
Lead Plating	ZY7010L and ZY7010LG	100% Matte Tin or 1.5µm Ag over 1.5µm Ni			
Moisture Sensitivity Level	ZY7010L	2			
	ZY7010LG	3			

### 4. Electrical Specifications

Specifications apply at the input voltage from 3V to 13.2V, output load from 0 to 10A, ambient temperature from -40°C to 85°C, 100µF output capacitance, and default performance parameters settings unless otherwise noted.

#### 4.1 Input Specifications

Parameter	Conditions/Description	Min	Nom	Max	Units
Input voltage ( $V_{IN}$ )	At $V_{IN} < 4.75V$ , VLDO pin needs to be connected to an external voltage source higher than 4.75V	3		13.2	VDC
Input Current (at no load)	$V_{IN} \geq 4.75V$ , VLDO pin connected to $V_{IN}$		50		mADC
Undervoltage Lockout (VLDO connected to $V_{IN}$ )	Ramping Up		4.2		VDC
	Ramping Down		3.75		VDC
Undervoltage Lockout (VLDO connected to $V_{AUX}=5V$ )	Ramping Up		3.0		VDC
	Ramping Down		2.5		VDC
External Low Voltage Supply	Connect to VLDO pin when $V_{IN} < 4.75V$	4.75		13.2	VDC
VLDO Input Current	Current drawn from the external low voltage supply at $V_{LDO}=5V$		50		mADC

#### 4.2 Output Specifications

Parameter	Conditions/Description	Min	Nom	Max	Units
Output Voltage Range ( $V_{OUT}$ )	Programmable <sup>1</sup> Default (no programming)	0.5	0.5	5.5	VDC VDC
Output Voltage Setpoint Accuracy	$V_{IN}=12V$ , $I_{OUT}=0.5 \cdot I_{OUT\ MAX}$ , $F_{SW}=500kHz$ , room temperature	(See Ordering Information)			
Output Current ( $I_{OUT}$ )	$V_{IN\ MIN}$ to $V_{IN\ MAX}$	-10 <sup>2</sup>		10	ADC
Line Regulation	$V_{IN\ MIN}$ to $V_{IN\ MAX}$		±0.4		% $V_{OUT}$
Load Regulation	0 to $I_{OUT\ MAX}$		±0.3		% $V_{OUT}$
Dynamic Regulation Peak Deviation Settling Time	Slew rate 2.5A/µs, 50 - 100% load step $C_{OUT}=220\mu F$ , $F_{SW}=1MHz$ to 10% of peak deviation		50		mV
			200		µs
Output Voltage Peak-to-Peak Ripple and Noise BW=20MHz Full Load	$V_{IN}=5.0V$ , $V_{OUT}=0.5V$ , $F_{SW}=500kHz$		10		mV
	$V_{IN}=5.0V$ , $V_{OUT}=2.5V$ , $F_{SW}=500kHz$		15		mV
	$V_{IN}=12V$ , $V_{OUT}=0.5V$ , $F_{SW}=500kHz$		15		mV
	$V_{IN}=12V$ , $V_{OUT}=2.5V$ , $F_{SW}=500kHz$		25		mV
	$V_{IN}=12V$ , $V_{OUT}=5.0V$ , $F_{SW}=500kHz$		45		mV
Temperature Coefficient	$V_{IN}=12V$ , $I_{OUT}=0.5 \cdot I_{OUT\ MAX}$		20		ppm/°C
Switching Frequency	Default		500		kHz
	Programmable, 250kHz steps	500		1,000	kHz
Duty Cycle Limit	Default		90.5		%
	Programmable, 1.56% steps	0		95	%

<sup>1</sup> ZY7010L is a step-down converter, thus the output voltage is always lower than the input voltage as show in Figure 1.

<sup>2</sup> At the negative output current (bus terminator mode) efficiency of the ZY7010L degrades resulting in increased internal power dissipation. Therefore maximum allowable negative current under specific conditions is 20% lower than the current determined from the derating curves shown in paragraph 5.5.

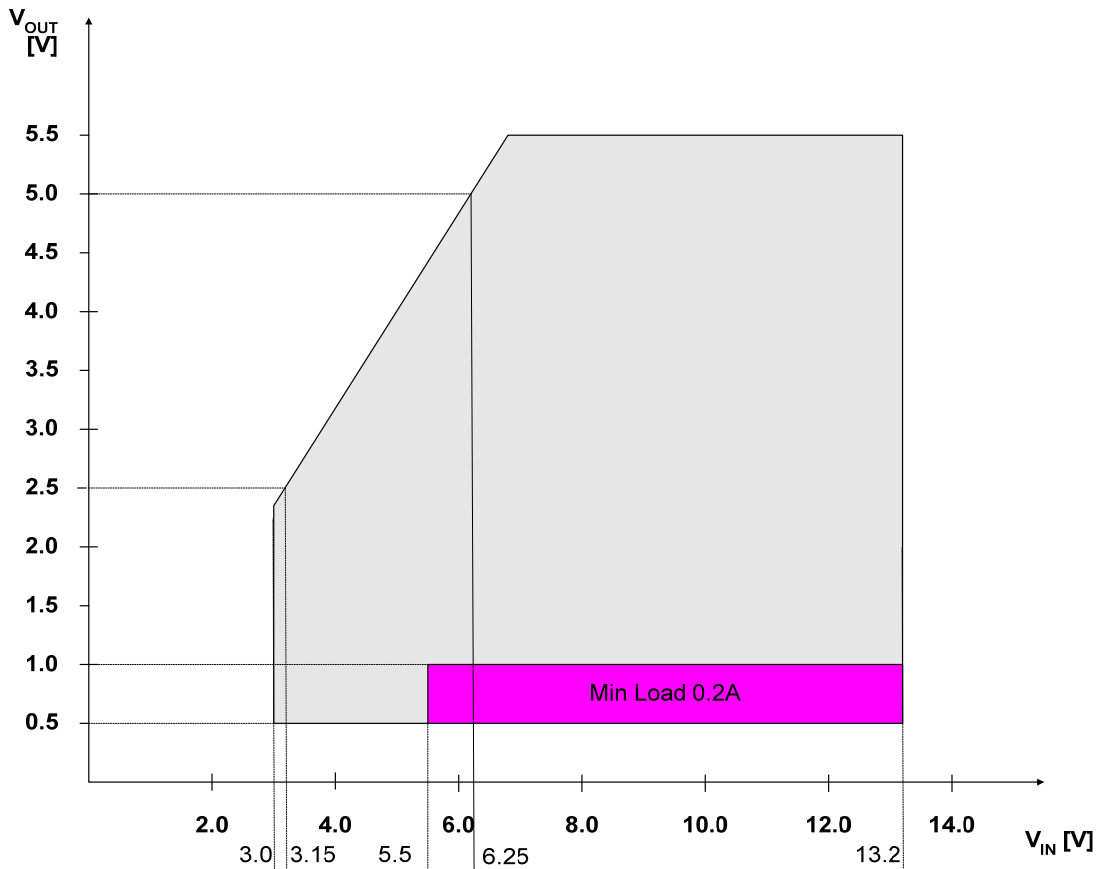

Figure 1. Output Voltage as a Function of Input Voltage and Output Current

### 4.3 Protection Specifications

Parameter	Conditions/Description	Min	Nom	Max	Units
<b>Output Overcurrent Protection</b>					
Type	Default Programmable	Non-Latching, 130ms period Latching/Non-Latching			
Threshold	Default Programmable in 11 steps	50	150	150	%I <sub>OUT</sub> %I <sub>OUT</sub>
Threshold Accuracy		-25		25	%I <sub>OCP.SET</sub>
<b>Output Overvoltage Protection</b>					
Type	Default Programmable	Non-Latching, 130ms period Latching/Non-Latching			
Threshold	Default Programmable in 10% steps	110 <sup>1</sup>	130	130	%V <sub>O.SET</sub> %V <sub>O.SET</sub>
Threshold Accuracy	Measured at V <sub>O.SET</sub> =2.5V	-2		2	%V <sub>OVP.SET</sub>
Delay	From instant when threshold is exceeded until the turn-off command is generated		6		μs

Output Undervoltage Protection					
Type	Default Programmable	Non-Latching, 130ms period Latching/Non-Latching			
Threshold	Default Programmable in 5% steps	75	75	85	%V <sub>O.SET</sub> %V <sub>O.SET</sub>
Threshold Accuracy	Measured at V <sub>O.SET</sub> =2.5V	-2		2	%V <sub>UVP.SET</sub>
Delay	From instant when threshold is exceeded until the turn-off command is generated		6		µs
Overtemperature Protection					
Type	Default Programmable	Non-Latching, 130ms period Latching/Non-Latching			
Turn Off Threshold	Temperature is increasing		130		°C
Turn On Threshold	Temperature is decreasing after the module was shut down by OTP		120		°C
Threshold Accuracy		-5		5	°C
Delay	From instant when threshold is exceeded until the turn-off command is generated		6		µs
Tracking Protection (when Enabled)					
Type	Default Programmable	Disabled Latching/Non-Latching, 130ms period			
Threshold	Enabled during output voltage ramping up			±250	mVDC
Threshold Accuracy		-50		50	mVDC
Delay	From instant when threshold is exceeded until the turn-off command is generated		6		µs
Overtemperature Warning					
Threshold	Always enabled, reported in Status register		120		°C
Threshold Accuracy		-5		5	°C
Hysteresis			3		°C
Delay	From instant when threshold is exceeded until the warning signal is generated		6		µs
Power Good Signal (PGOOD pin)					
Logic	V <sub>OUT</sub> is inside the PG window V <sub>OUT</sub> is outside the PG window		High Low		N/A
Lower Threshold	Default Programmable in 5% steps	90	90	95	%V <sub>O.SET</sub> %V <sub>O.SET</sub>
Upper Threshold			110		%V <sub>O.SET</sub>
Delay	From instant when threshold is exceeded until status of PG signal changes		6		µs
Threshold Accuracy	Measured at V <sub>O.SET</sub> =2.5V	-2		2	%V <sub>O.SET</sub>

<sup>1</sup> Minimum OVP threshold is 1.0V

#### 4.4 Feature Specifications

Parameter	Conditions/Description	Min	Nom	Max	Units
<b>Current Share</b>					
Type		Active, Single Line			
Maximum Number of Modules Connected in Parallel	$I_{OUT\ MIN}=0$	4			
Current Share Accuracy	$I_{OUT\ MIN} \geq 20\% * I_{OUT\ NOM}$			±20	% $I_{OUT}$
<b>Interleave</b>					
Interleave (Phase Shift)	Default Programmable in 11.25° steps	0	0	348.75	Degree degree
<b>Sequencing</b>					
Turn ON Delay	Default Programmable in 1ms steps	0	0	255	ms ms
Turn OFF Delay	Default Programmable in 1ms steps	0	0	63	ms ms
<b>Tracking</b>					
Turn ON Slew Rate	Default Programmable in 7 steps	0.1	0.1	8.33 <sup>1</sup>	V/ms V/ms
Turn OFF Slew Rate	Default Programmable in 7 steps	-0.1	-0.1	-8.33 <sup>1</sup>	V/ms V/ms
<b>Optimal Voltage Positioning</b>					
Load Regulation	Default Programmable in 7 steps	0	0	11.76	mV/A mV/A
<b>Feedback Loop Compensation</b>					
Zero 1 (Effects phase lead and increases gain in mid-band)	Programmable	0.05		50	kHz
Zero 2 (Effects phase lead and increases gain in mid-band)	Programmable	0.05		50	kHz
Pole 1 (Integrator Pole, effects loop gain)	Programmable	0.05		50	kHz
Pole 2 (Effects phase lag and limits gain in mid-band)	Programmable	1		1000	kHz
Pole 3 (High frequency low-pass filter to limit PWM noise)	Programmable	1		1000	kHz
<b>Monitoring</b>					
Voltage Monitoring Accuracy	1 LSB=22mV	-2% $V_{OUT}$ - 1 LSB		2% $V_{OUT}$ + 1 LSB	mV
Current Monitoring Accuracy	$20\% * I_{OUT\ NOM} < I_{OUT} < I_{OUT\ NOM}$	-20		+20	% $I_{OUT}$
Temperature Monitoring Accuracy	Junction temperature of POL controller	-5		+5	°C
<b>Remote Voltage Sense (+VS and -VS pins)</b>					
Voltage Drop Compensation	Between +VS and VOUT			300	mV
Voltage Drop Compensation	Between -VS and PGND			100	mV

<sup>1</sup> Achieving fast slew rates under specific line and load conditions may require feedback loop adjustment

#### 4.5 Signal Specifications

Parameter	Conditions/Description	Min	Nom	Max	Units
VDD	Internal supply voltage	3.15	3.3	3.45	V
<b>SYNC/DATA Line (SD pin)</b>					
ViL_sd	LOW level input voltage	-0.5		0.3 x VDD	V
ViH_sd	HIGH level input voltage	0.75 x VDD		VDD + 0.5	V
Vhyst_sd	Hysteresis of input Schmitt trigger	0.25 x VDD		0.45 x VDD	V
VoL	LOW level sink current @ 0.5V	14		60	mA
Tr_sd	Maximum allowed rise time 10/90%VDD			300	ns
Cnode_sd	Added node capacitance		5	10	pF
Ipu_sd	Pull-up current source at Vsd=0V	0.3		1.0	mA
Freq_sd	Clock frequency of external SD line	475		525	kHz
Tsynq	Sync pulse duration	22		28	% of clock cycle
T0	Data=0 pulse duration	72		78	% of clock cycle
<b>Inputs: ADDR0...ADDR4, EN, IM</b>					
ViL_x	LOW level input voltage	-0.5		0.3 x VDD	V
ViH_x	HIGH level input voltage	0.7 x VDD		VDD+0.5	V
Vhyst_x	Hysteresis of input Schmitt trigger	0.1 x VDD		0.3 x VDD	V
RdnL_ADDR	External pull down resistance ADDR <sub>X</sub> forced low			10	kOhm
<b>Power Good and OK Inputs/Outputs</b>					
Iup_PG	Pull-up current source input forced low PG	25		110	μA
Iup_OK	Pull-up current source input forced low OK	175		725	μA
ViL_x	LOW level input voltage	-0.5		0.3 x VDD	V
ViH_x	HIGH level input voltage	0.7 x VDD		VDD+0.5	V
Vhyst_x	Hysteresis of input Schmitt trigger	0.1 x VDD		0.3 x VDD	V
IoL	LOW level sink current at 0.5V	4		20	mA
<b>Current Share Bus (CS pin)</b>					
Iup_CS	Pull-up current source at VCS = 0V	0.84		3.1	mA
ViL_CS	LOW level input voltage	-0.5		0.3 x VDD	V
ViH_CS	HIGH level input voltage	0.75 x VDD		VDD+0.5	V
Vhyst_CS	Hysteresis of input Schmitt trigger	0.25 x VDD		0.45 x VDD	V
IoL	LOW level sink current at 0.5V	14		60	mA
Tr_CS	Maximum allowed rise time 10/90% VDD			100	ns



**5. Typical Performance Characteristics**

**5.1 Efficiency Curves**

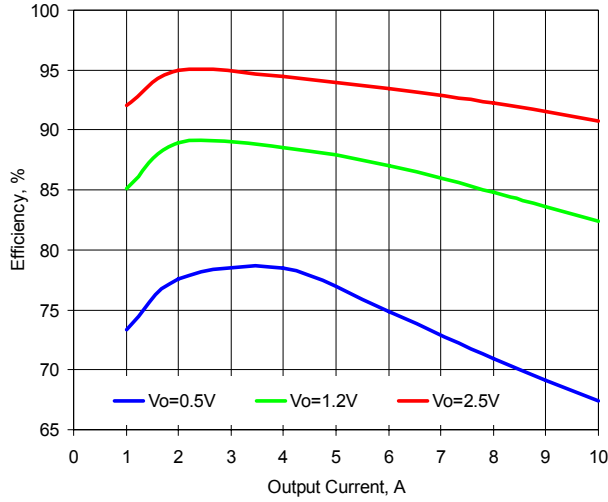

**Figure 2. Efficiency vs. Load. Vin=3.3V, Fsw=500kHz**

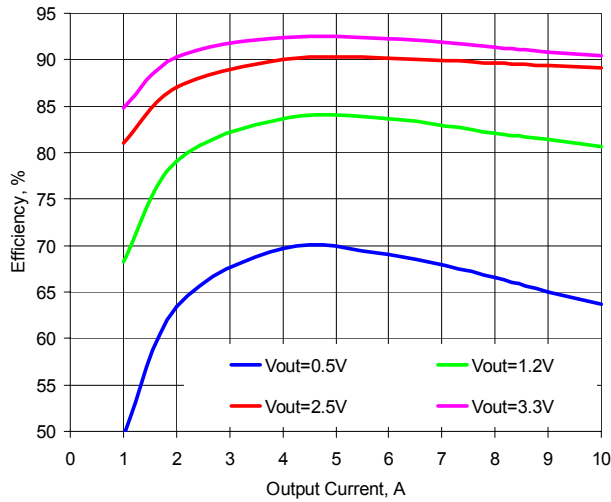

**Figure 3. Efficiency vs. Load. Vin=5V, Fsw=500kHz**

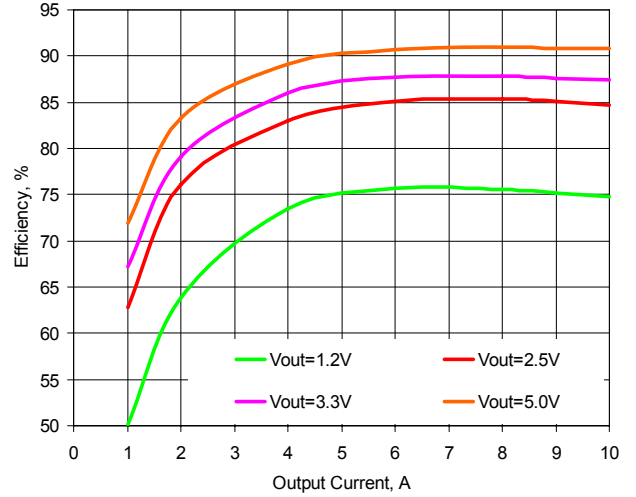

**Figure 4. Efficiency vs. Load. Vin=12V, Fsw=500kHz**

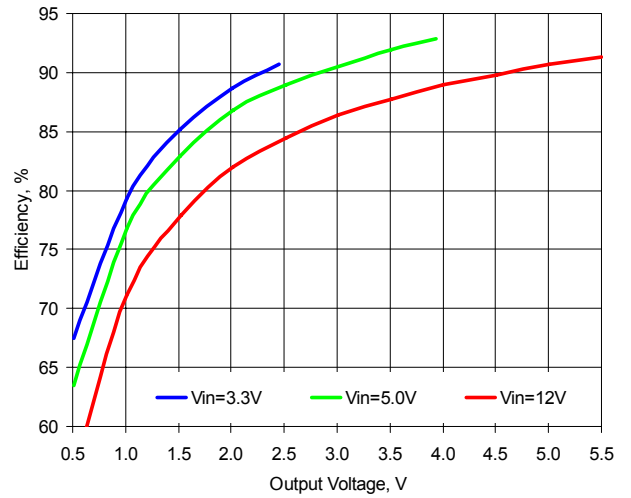

**Figure 5. Efficiency vs. Output Voltage, Iout=10A, Fsw=500kHz**



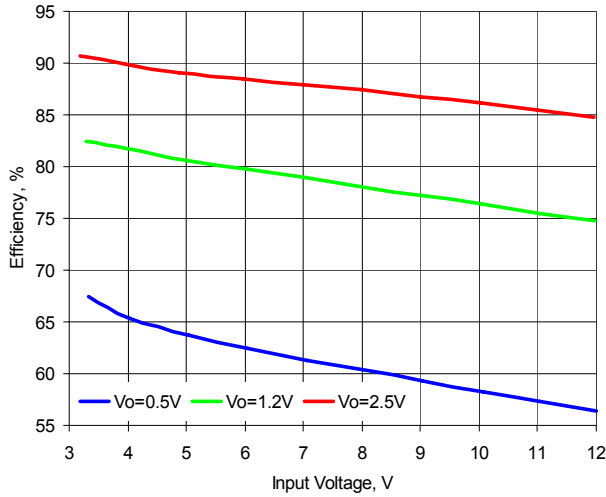

Figure 6. Efficiency vs. Input Voltage. Iout=10A, Fsw=500kHz

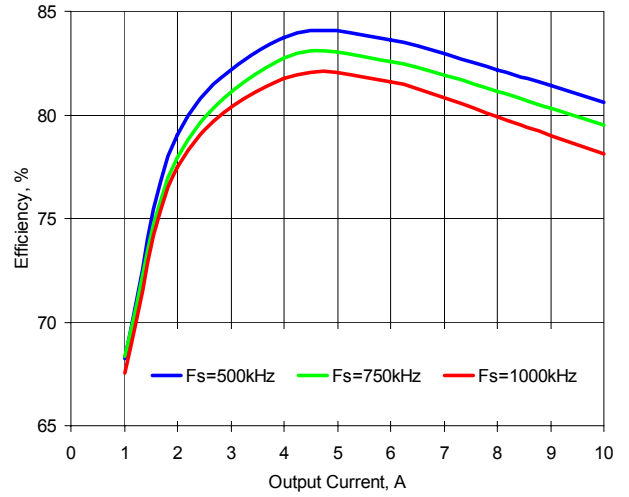

Figure 8. Efficiency vs. Load. Vin=5V, Vout=1.2V

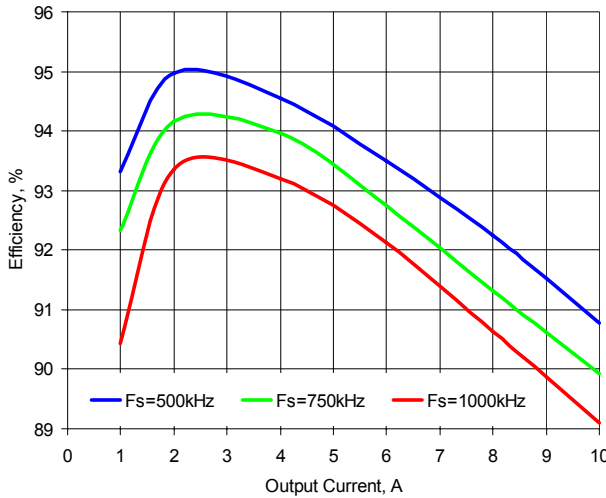

Figure 7. Efficiency vs. Load. Vin=3.3V, Vout=2.5V

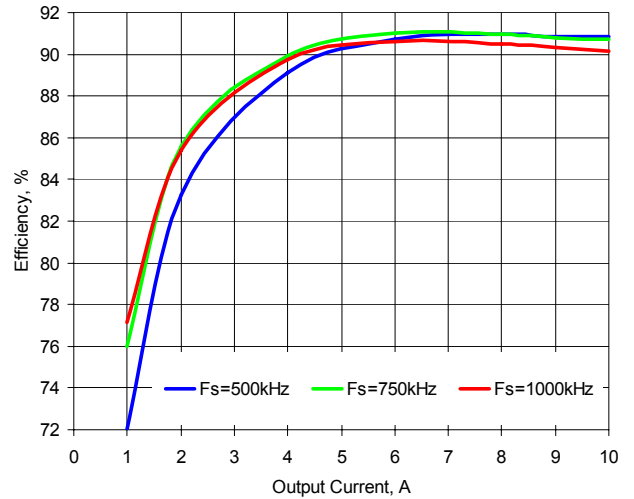

Figure 9. Efficiency vs. Load. Vin=12V, Vout=5V



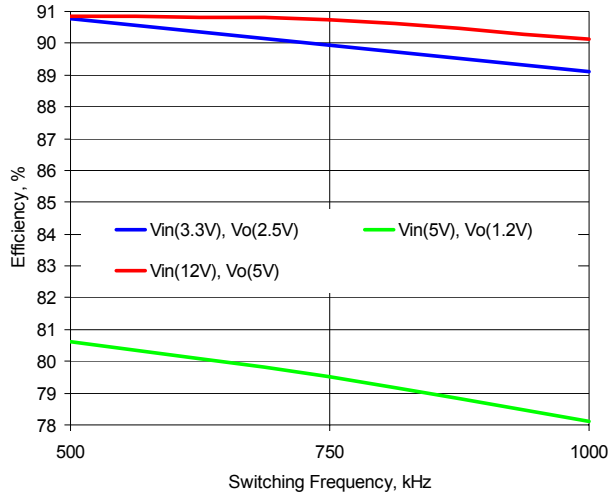

Figure 10. Efficiency vs. Switching Frequency.  $I_{out}=10A$

## 5.2 Turn-On Characteristics

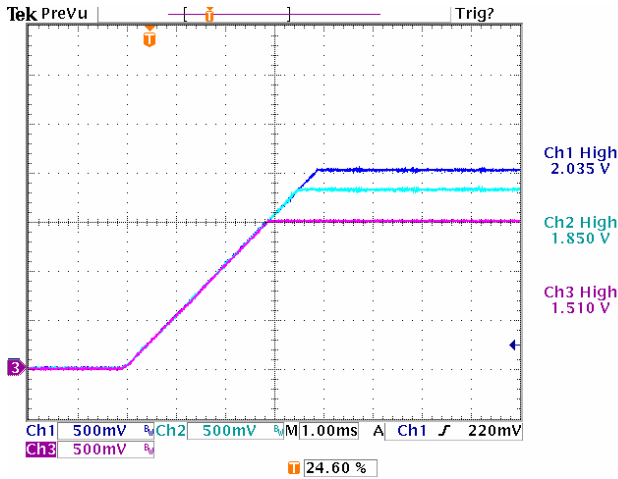

Figure 11. Tracking Turn-On. Rising Slew Rate is Programmed at 0.5V/ms.  
 $V_{in}=12V$ , Ch1 – V1, Ch2 – V2, Ch3 – V3

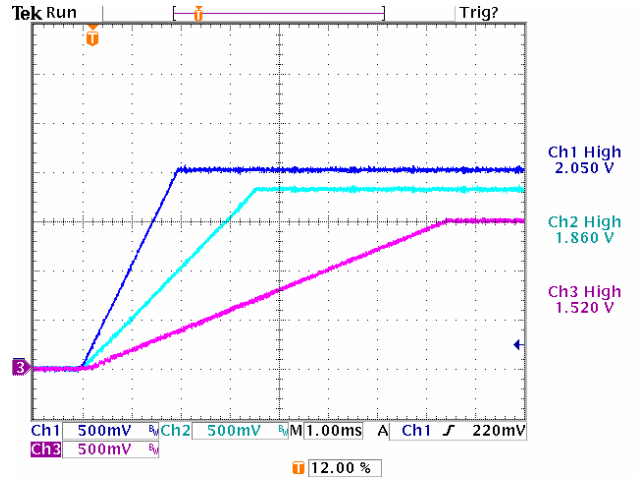

Figure 12. Turn-On with Different Rising Slew Rates.  
 Rising Slew Rates are Programmed as follows: V1-1V/ms, V2-0.5V/ms, V3-0.2V/ms.  
 $V_{in}=12V$ , Ch1 – V1, Ch2 – V2, Ch3 – V3

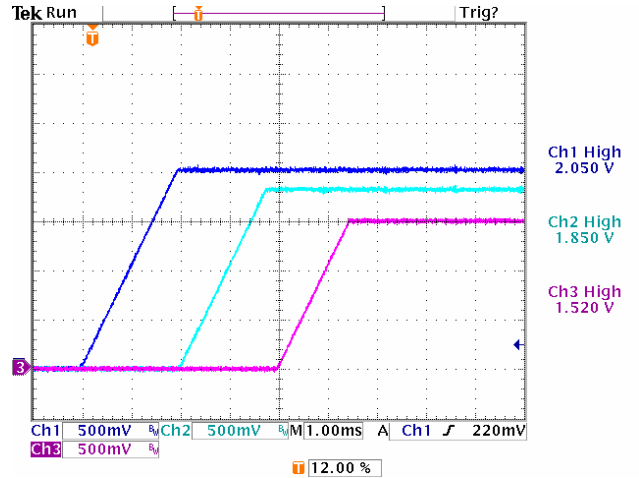

Figure 13. Sequenced Turn-On. Rising Slew Rate is Programmed at 1V/ms. V2 Delay is 2ms, V3 delay is 4ms.  $V_{in}=12V$ , Ch1 – V1, Ch2 – V2, Ch3 – V3



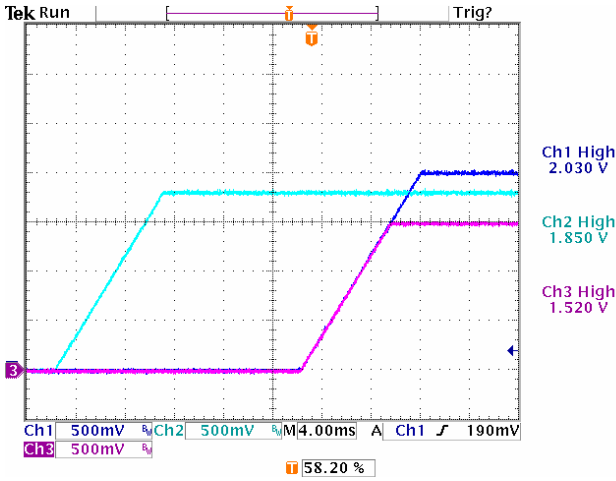

Figure 14. Turn On with Sequencing and Tracking. Rising Slew Rate Programmed at 0.2V/ms, V1 and V3 delays are programmed at 20ms.  
 Vin=12V, Ch1 – V1, Ch2 – V2, Ch3 – V3

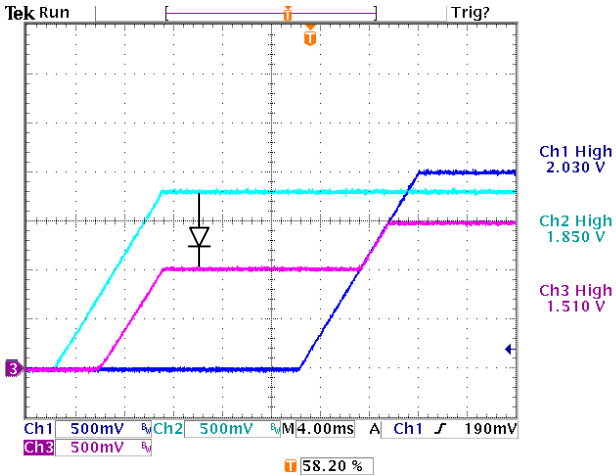

Figure 15. Turn On into Prebiased Load. V3 is Prebiased by V2 via a Diode.  
 Vin=12V, Ch1 – V1, Ch2 – V2, Ch3 – V3

### 5.3 Turn-Off Characteristics

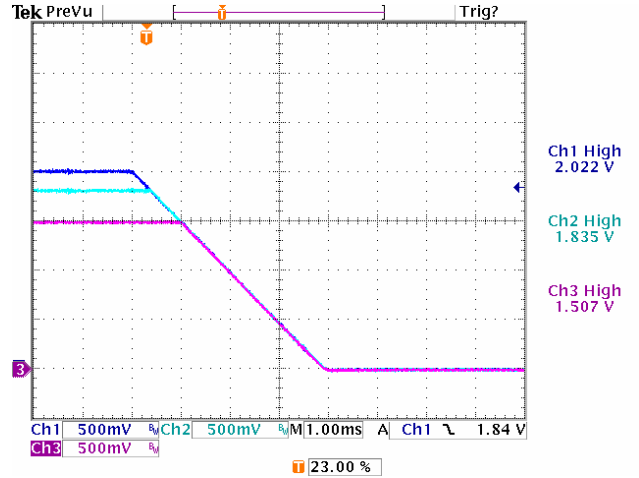

Figure 16. Tracking Turn-Off. Falling Slew Rate is Programmed at 0.5V/ms.  
 Vin=12V, Ch1 – V1, Ch2 – V2, Ch3 – V3

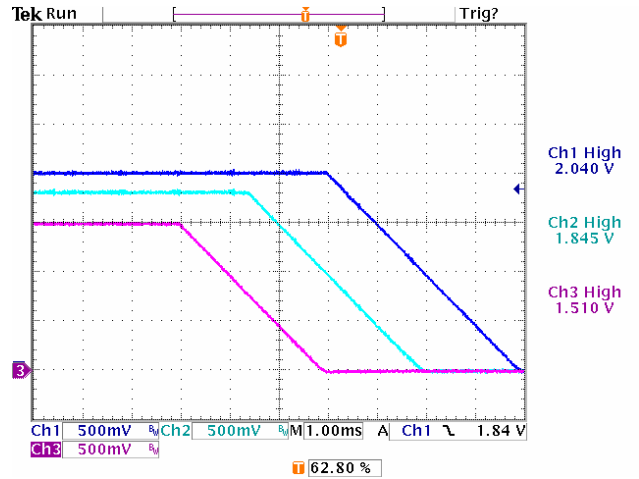

Figure 17. Turn-Off with Tracking and Sequencing. Falling Slew Rate is Programmed at 0.5V/ms.  
 Vin=12V, Ch1 – V1, Ch2 – V2, Ch3 – V3



### 5.4 Transient Response

The pictures below show the deviation of the output voltage in response to the 50-100-50% step load at 2.5A/μs. In all tests the POL converters were switching at 1MHz and had 10x22μF ceramic capacitors connected across the output pins. Bandwidth of the feedback loop was programmed for faster transient response.

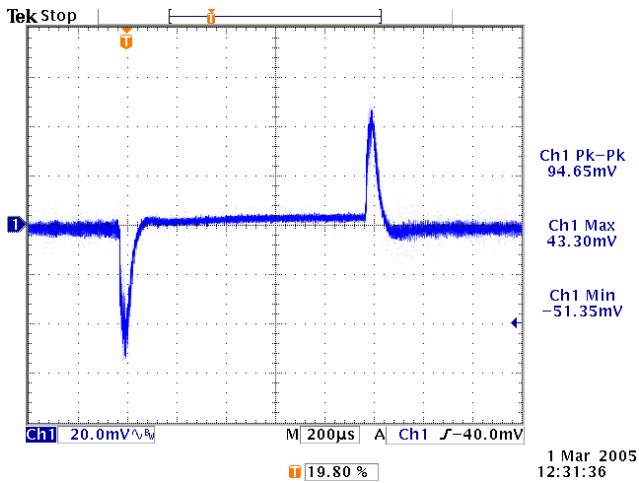

Figure 18. Vin=12V, Vout=5V, BW=60kHz.

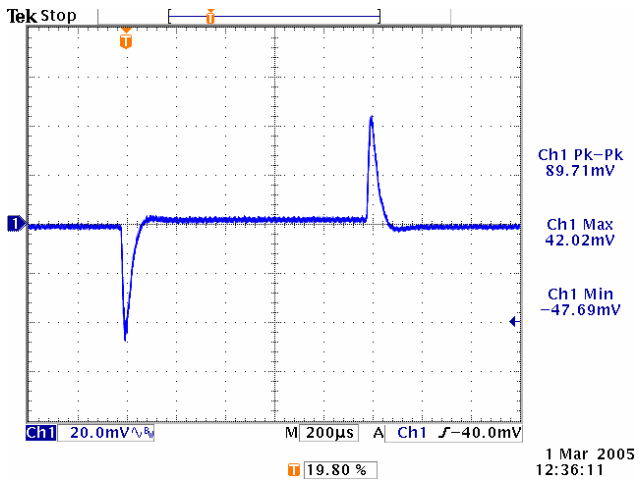

Figure 19. Vin=12V, Vout=1V, BW=60kHz.

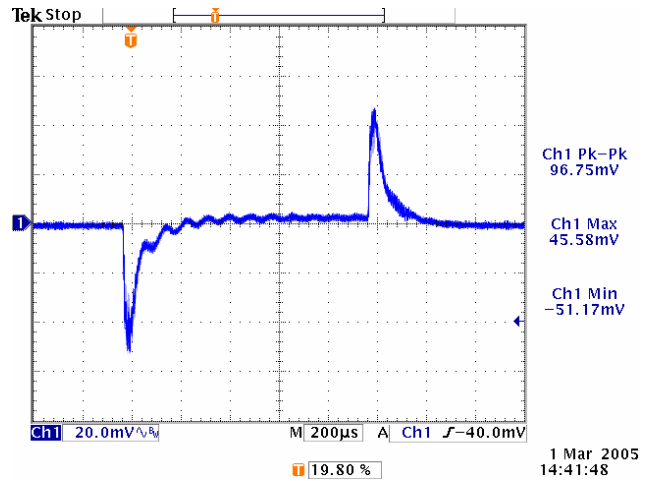

Figure 20. Vin=5V, Vout=2.5V, BW=60kHz.

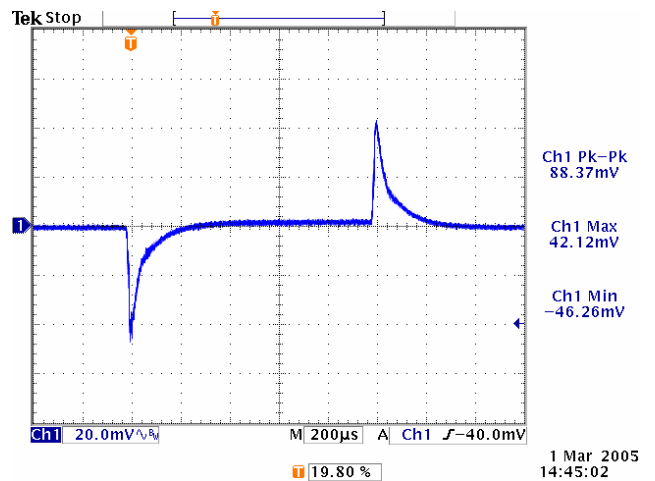

Figure 21. Vin=5V, Vout=1V, BW=60kHz.

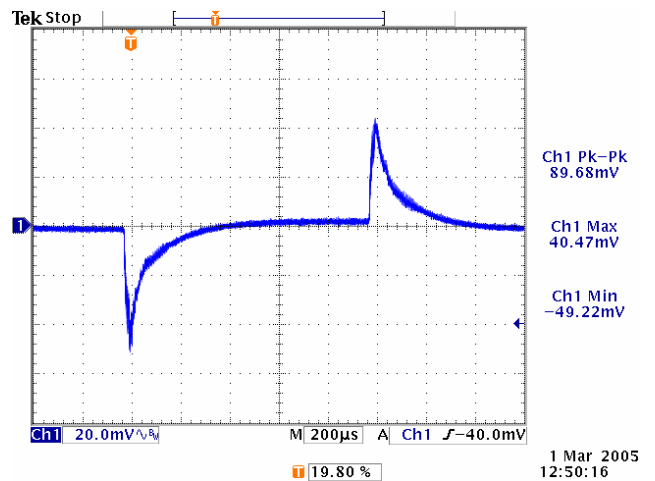

Figure 22. Vin=3.3V, Vout=1V, BW=60kHz.

5.5 Thermal Derating Curves

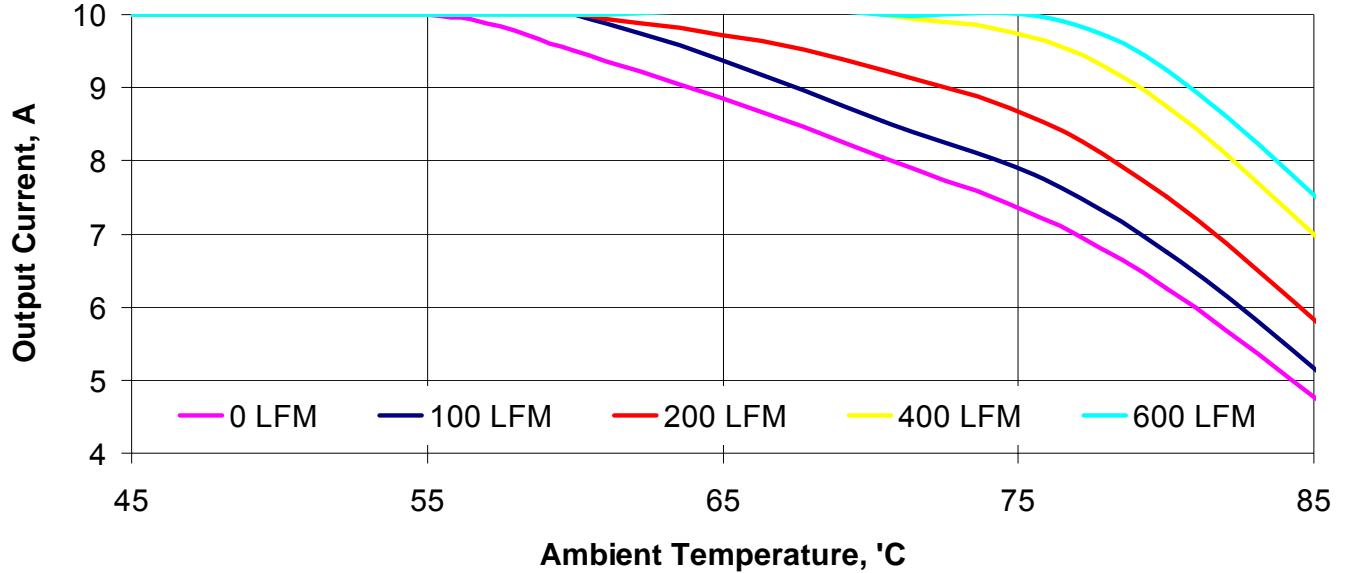

Figure 23. Thermal Derating Curves. Vin=13.2V, Vout=5.0V, Fsw=500kHz

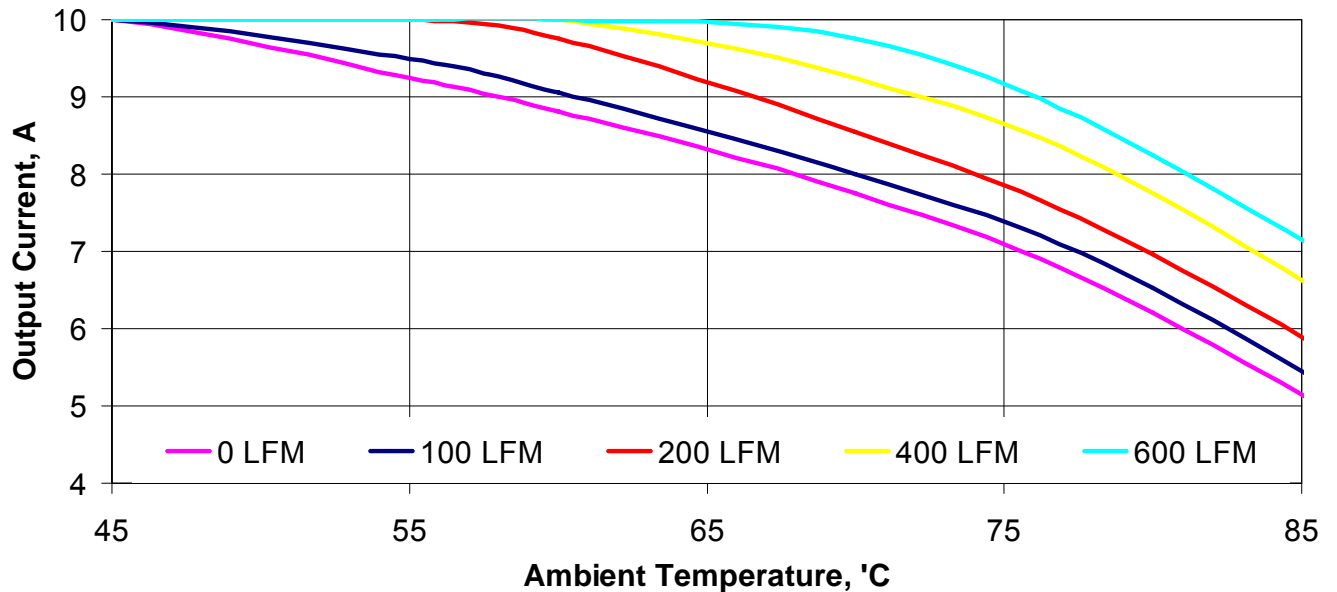

Figure 24. Thermal Derating Curves. Vin=13.2V, Vout=5.0V, Fsw=1MHz

6. Typical Application

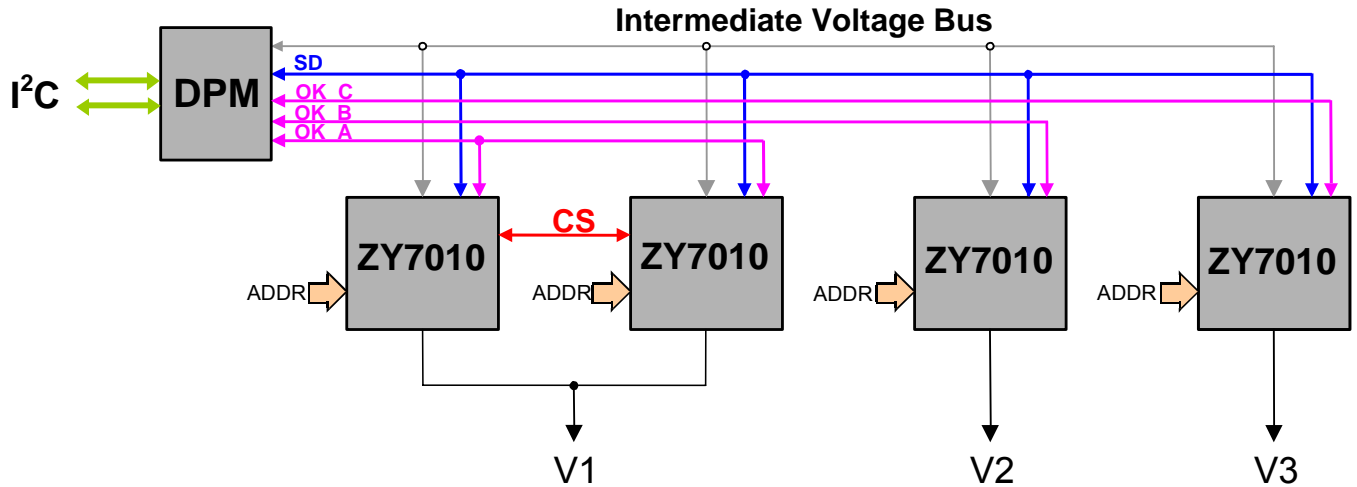

Figure 25. Block Diagram of Typical Multiple Output Application with Digital Power Manager and I<sup>2</sup>C Interface

The block diagram of a typical application of ZY7010L point-of-load converters (POL) is shown in Figure 25. The system includes multiple POLs and a ZM7000 series Digital Power Manager (DPM). All POLs are connected to the DPM and to each other via a single-wire SD (sync/data) line. The line provides synchronization of all POLs to the master clock generated by the DPM and simultaneously performs bidirectional data transfer between POLs and the DPM. Each POL has a unique 5-bit address programmed by grounding respective address pins. To enable the current share, CS pins of POLs connected in parallel are linked together.

There are three groups of POLs in the application, groups A, B, and group C. A group is defined as a number of POLs interconnected via OK pins. Grouping of POLs enables users to program, control, and monitor multiple POLs simultaneously and execute advanced fault management schemes.

The complete schematic of the application is shown in Figure 26.

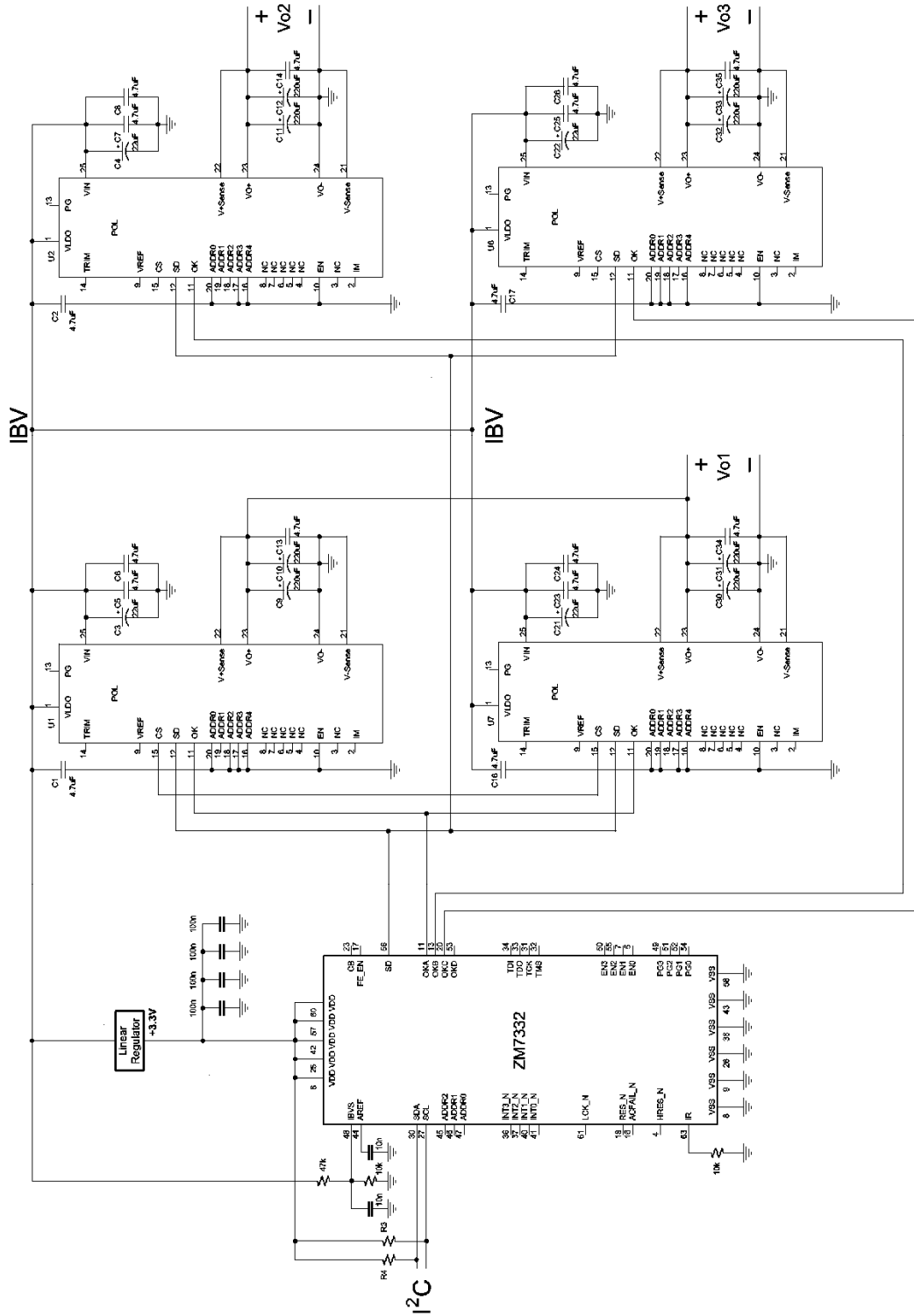

Figure 26. Complete Schematic of the Application Shown in Figure 25. Intermediate Bus Voltage is from 4.75V to 13.2V.



# ZY7010L 10A DC-DC Intelligent POL Data Sheet

## 3V to 13.2V Input • 0.5V to 5.5V Output



### 7. Pin Assignments and Description

Pin Name	Pin Number	Pin Type	Buffer Type	Pin Description	Notes
VLDO	1	P		Low Voltage Dropout	Connect to an external voltage source higher than 4.75V, if $V_{IN} < 4.75V$ . Connect to $V_{IN}$ , if $V_{IN} \geq 4.75V$
IM	2			Not Used	Leave floating
NC	3			Not Used	Leave floating
NC	4			Not Used	Leave floating
NC	5			Not Used	Leave floating
NC	6			Not Used	Leave floating
NC	7			Not Used	Leave floating
NC	8			Not Used	Leave floating
VREF	9			Not Used	Leave floating
EN	10			Connect to PGND	Connect to PGND
OK	11	I/O	PU	Fault/Status Condition	Connect to OK pin of other Z-POL and/or DPM. Leave floating, if not used
SD	12	I/O	PU	Sync/Data Line	Connect to SD pin of DPM
PGOOD	13	I/O	PU	Power Good	
TRIM	14			Not Used	Leave floating
CS	15	I/O	PU	Current Share	Connect to CS pin of other Z-POLs connected in parallel
ADDR4	16	I	PU	POL Address Bit 4	Tie to PGND for 0 or leave floating for 1
ADDR3	17	I	PU	POL Address Bit 3	Tie to PGND for 0 or leave floating for 1
ADDR2	18	I	PU	POL Address Bit 2	Tie to PGND for 0 or leave floating for 1
ADDR1	19	I	PU	POL Address Bit 1	Tie to PGND for 0 or leave floating for 1
ADDR0	20	I	PU	POL Address Bit 0	Tie to PGND for 0 or leave floating for 1
-VS	21	I	PU	Negative Voltage Sense	Connect to the negative point close to the load
+VS	22	I	PU	Positive Voltage Sense	Connect to the positive point close to the load
VOUT	23	P		Output Voltage	
PGND	24	P		Power Ground	
VIN	25	P		Input Voltage	

Legend: I=input, O=output, I/O=input/output, P=power, A=analog, PU=internal pull-up





### 8. Programmable Features

Performance parameters of ZY7010L POL converters can be programmed via the industry standard I<sup>2</sup>C communication bus without replacing any components or rewiring PCB traces. Each parameter has a default value stored in the volatile memory registers detailed in Table 1. The setup registers 00h through 14h are programmed at the system power-up. When the user programs new performance parameters, the values in the registers are overwritten. Upon removal of the input voltage, the default values are restored.

Table 1. ZY7010L Memory Registers

Register	Content	Address
PC1	Protection Configuration 1	00h
PC2	Protection Configuration 2	01h
PC3	Protection Configuration 3	02h
DON	Turn-On Delay	05h
DOF	Turn-Off Delay	06h
TC	Tracking Configuration	03h
INT	Interleave Configuration and Frequency Selection	04h
RUN	RUN Register	15h
ST	Status Register	16h
VOS	Output Voltage Setpoint	07h
CLS	Current Limit Setpoint	08h
DCL	Duty Cycle Limit	09h
B1	Dig Controller Denominator z <sup>-1</sup> Coefficient	0Ah
B2	Dig Controller Denominator z <sup>-2</sup> Coefficient	0Bh
B3	Dig Controller Denominator z <sup>-3</sup> Coefficient	0Ch
C0L	Dig Controller Numerator z <sup>0</sup> Coefficient, Low Byte	0Dh
C0H	Dig Controller Numerator z <sup>0</sup> Coefficient, High Byte	0Eh
C1L	Dig Controller Numerator z <sup>-1</sup> Coefficient, Low Byte	0Fh
C1H	Dig Controller Numerator z <sup>-1</sup> Coefficient, High Byte	10h
C2L	Dig Controller Numerator z <sup>-2</sup> Coefficient, Low Byte	11h
C2H	Dig Controller Numerator z <sup>-2</sup> Coefficient, High Byte	12h
C3L	Dig Controller Numerator z <sup>-3</sup> Coefficient, Low Byte	13h
C3H	Dig Controller Numerator z <sup>-3</sup> Coefficient, High Byte	14h
VOM	Output Voltage Monitoring	17h
IOM	Output Current Monitoring	18h
TMP	Temperature Monitoring	19h

ZY7010L converters can be programmed using the Graphical User Interface or directly via the I<sup>2</sup>C bus by using high and low level commands as described in the "DPM Programming Manual".

ZY7010L parameters can be reprogrammed at any time during the system operation and service except for the digital filter coefficients, the switching frequency and the duty cycle limit, that can only be changed when the POL is turned off.

### 8.1 Output Voltage

The output voltage can be programmed in the GUI Output Configuration window shown in the Figure 27 or directly via the I<sup>2</sup>C bus by writing into the VOS register shown in Figure 28.

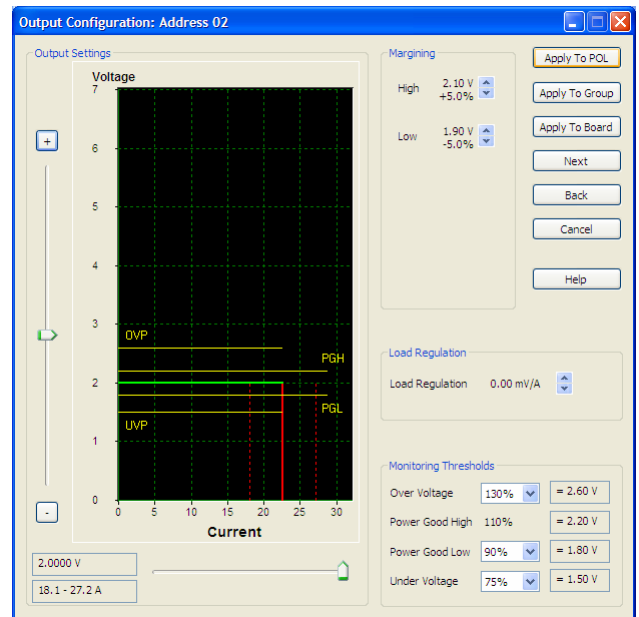

Figure 27. Output Configuration Window

R/W-0	R/W-0	R/W-0	R/W-0	R/W-0	R/W-0	R/W-0	R/W-0
VOS7	VOS6	VOS5	VOS4	VOS3	VOS2	VOS1	VOS0
Bit 7				Bit 0			
Bit 7:0 <b>VOS[7:0]</b> , Output voltage setting 00h: corresponds to 0.5000V 01h: corresponds to 0.5125V ... 77h: corresponds to 1.9875V 78h: corresponds to 2.0000V 79h: corresponds to 2.025V ... F9h: corresponds to 5.225V FAh: corresponds to 5.250V FBh: corresponds to 5.300V ... FFh: corresponds to 5.500V							
R = Readable bit W = Writable bit U = Unimplemented bit, read as '0' - n = Value at POR reset							

Figure 28. Output Voltage Setpoint Register VOS





### 8.1.1 Output Voltage Setpoint

The output voltage programming range is from 0.5V to 5.5V. Within this range, there are 256 predefined voltage setpoints. To improve resolution of the output voltage settings, the voltage range is divided into three sub-ranges as shown in Table 2.

Table 2. Output Voltage Adjustment Resolution

V <sub>OUT MIN</sub> , V	V <sub>OUT MAX</sub> , V	Resolution, mV
0.500	2.000	12.5
2.025	5.25	25
5.3	5.5	50

### 8.1.2 Output Voltage Margining

If the output voltage needs to be varied by a certain percentage, the margining function can be utilized. The margining can be programmed in the GUI Output Configuration window or directly via the I<sup>2</sup>C bus using high level commands as described in the "DPM Programming Manual".

In order to properly margin POLs that are connected in parallel, the POLs must be members of one of the Parallel Buses. Refer to the GUI System Configuration Window shown in Figure 55.

### 8.1.3 Optimal Voltage Positioning

Optimal voltage positioning increases the voltage regulation window by properly positioning the output voltage setpoint. Positioning is determined by the load regulation that can be programmed in the GUI Output Configuration window shown in Figure 27 or directly via the I<sup>2</sup>C bus by writing into the CLS register shown in Figure 38.

Figure 29 illustrates optimal voltage positioning concept. If no load regulation is programmed, the headroom (voltage differential between the output voltage setpoint and a regulation limit) is approximately half of the voltage regulation window. When load regulation is programmed, the output voltage will decrease as the output current increases, so the VI characteristic will have a negative slope. Therefore, by properly selecting the operating point, it is possible to increase the headroom as shown in the picture.

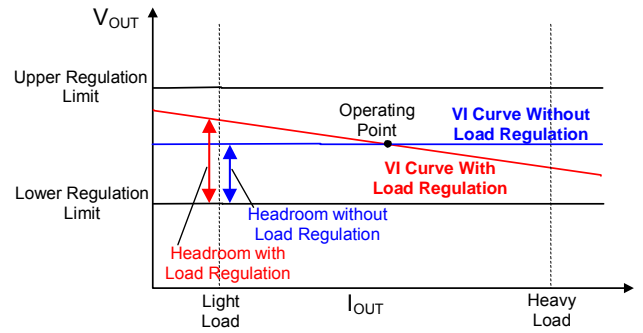

Figure 29. Concept of Optimal Voltage Positioning

Increased headroom allows tolerating larger voltage deviations. For example, the step load change from light to heavy load will cause the output voltage to drop. If the optimal voltage positioning is utilized, the output voltage will stay within the regulation window. Otherwise, the output voltage will drop below the lower regulation limit. To compensate for the voltage drop external output capacitance will need to be added, thus increasing cost and complexity of the system.

The effect of optimal voltage positioning is shown in Figure 30 and Figure 31. In this case, switching output load causes large peak-to-peak deviation of the output voltage. By programming load regulation, the peak to peak deviation is dramatically reduced.

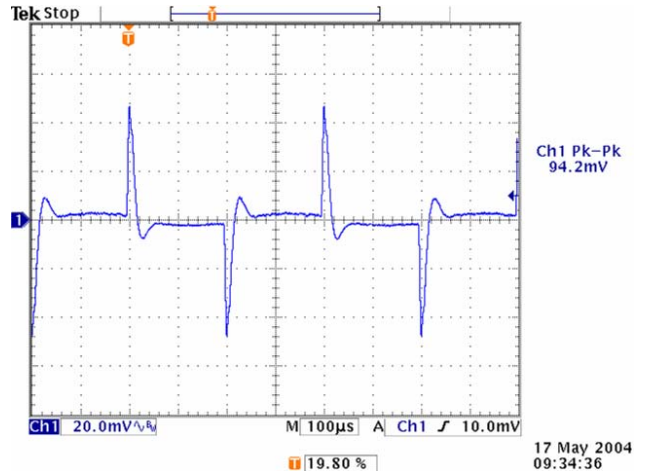

Figure 30. Transient Response without Optimal Voltage Positioning



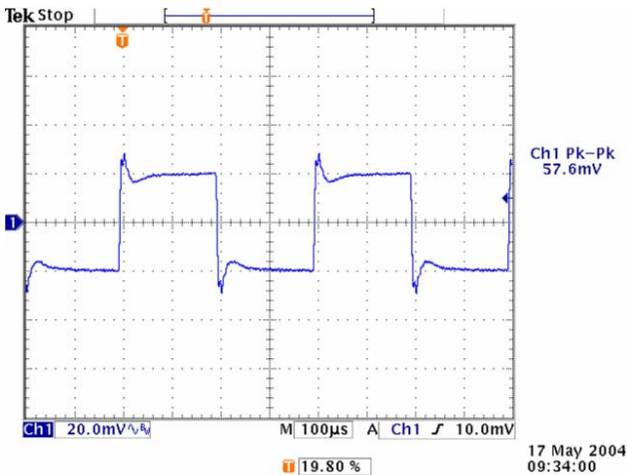

Figure 31. Transient Response with Optimal Voltage Positioning

## 8.2 Sequencing and Tracking

Turn-on delay, turn-off delay, and rising and falling output voltage slew rates can be programmed in the GUI Sequencing/Tracking window shown in Figure 32 or directly via the I<sup>2</sup>C bus by writing into the DON, DOF, and TC registers, respectively. The registers are shown in Figure 33, Figure 34, and Figure 36.

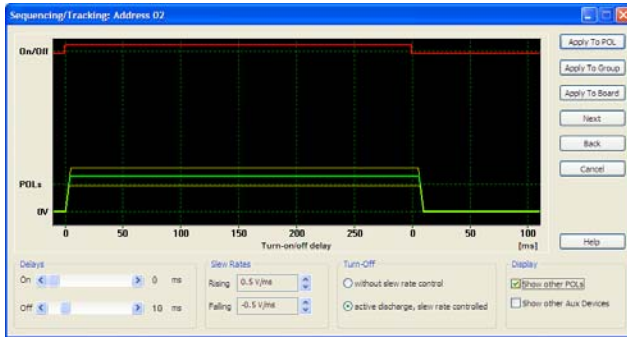

Figure 32. Sequencing/Tracking Window

### 8.2.1 Turn-On Delay

Turn-on delay is defined as an interval from the application of the Turn-On command until the output voltage starts ramping up.

R/W-0	R/W-0	R/W-0	R/W-0	R/W-0	R/W-0	R/W-0	R/W-0
DON7	DON6	DON5	DON4	DON3	DON2	DON1	DON0
Bit 7							Bit 0
Bit 7:0 <b>DON[7:0]</b> : Turn-on delay time							
00h: corresponds to 0ms delay after turn-on command has occurred							
...							
FFh: corresponds to 255ms delay after turn-on command has occurred							

Figure 33. Turn-On Delay Register DON

### 8.2.2 Turn-Off Delay

U	U	R/W-0	R/W-0	R/W-0	R/W-0	R/W-0	R/W-0
---	---	DOF5	DOF4	DOF3	DOF2	DOF1	DOF0
Bit 7							Bit 0
Bit 7:6 <b>Unimplemented</b> , read as '0'							
Bit 5:0 <b>DOF[5:0]</b> : Turn-off delay time							
00h: corresponds to 0ms delay after turn-off command has occurred							
...							
3Fh: corresponds to 63ms delay after turn-off command has occurred							

Figure 34. Turn-Off Delay Register DOF

Turn-off delay is defined as an interval from the application of the Turn-Off command until the output voltage reaches zero (if the falling slew rate is programmed) or until both high side and low side switches are turned off (if the slew rate is not programmed). Therefore, for the slew rate controlled turn-off the ramp-down time is included in the turn-off delay as shown in Figure 35.

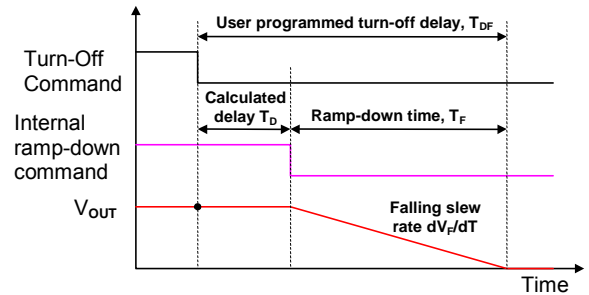

Figure 35. Relationship between Turn-Off Delay and Falling Slew Rate

As it can be seen from the figure, the internally calculated delay  $T_D$  is determined by the equation below.

$$T_D = T_{DF} - \frac{V_{OUT}}{dV_F/dT}$$

For proper operation  $T_D$  shall be greater than zero. The appropriate value of the turn-off delay needs to be programmed to satisfy the condition.





If the falling slew rate control is not utilized, the turn-off delay only determines an interval from the application of the Turn-Off command until both high side and low side switches are turned off. In this case, the output voltage ramp-down process is determined by load parameters.

### 8.2.3 Rising and Falling Slew Rates

The output voltage tracking is accomplished by programming the rising and falling slew rates of the output voltage. To achieve programmed slew rates, the output voltage is being changed in 12.5mV steps where duration of each step determines the slew rate. For example, ramping up a 1.0V output with a slew rate of 0.5V/ms will require 80 steps duration of 25µs each.

Duration of each voltage step is calculated by dividing the master clock frequency generated by the DPM. Since all POLs in the system are synchronized to the master clock, the matching of voltage slew rates of different outputs is very accurate as it can be seen in Figure 11 and Figure 16.

During the turn on process, a POL not only delivers current required by the load ( $I_{LOAD}$ ), but also charges the load capacitance. The charging current can be determined from the equation below:

$$I_{CHG} = C_{LOAD} \times \frac{dV_R}{dt}$$

Where,  $C_{LOAD}$  is load capacitance,  $dV_R/dt$  is rising voltage slew rate, and  $I_{CHG}$  is charging current.

When selecting the rising slew rate, a user needs to ensure that

$$I_{LOAD} + I_{CHG} < I_{OCP}$$

Where  $I_{OCP}$  is the overcurrent protection threshold of the ZY7010L. If the condition is not met, then the overcurrent protection will be triggered during the turn-on process. To avoid this,  $dV_R/dt$  and the overcurrent protection threshold should be programmed to meet the condition above.

U	R/W-0	R/W-0	R/W-0	R/W-1	R/W-0	R/W-0	R/W-0
---	R2	R1	R0	SC	F2	F1	F0
Bit 7				Bit 0			
Bit 7	<b>Unimplemented</b> , read as '0'						
Bit 6:4	<b>R[2:0]</b> : Value of $V_o$ rising slope 0: corresponds to 0.1V/ms (default) 1: corresponds to 0.2V/ms 2: corresponds to 0.5V/ms 3: corresponds to 1.0V/ms 4: corresponds to 2.0V/ms 5: corresponds to 5.0V/ms 6: corresponds to 8.3V/ms 7: corresponds to 8.3V/ms						
Bit 3	<b>SC</b> , Slew rate control at turn-off 0: Slew rate control is disabled 1: Slew rate control is enabled						
Bit 2:0	<b>F[2:0]</b> : Value of $V_o$ falling slope 0: corresponds to -0.1V/ms (default) 1: corresponds to -0.2V/ms 2: corresponds to -0.5V/ms 3: corresponds to -1.0V/ms 4: corresponds to -2.0V/ms 5: corresponds to -5.0V/ms 6: corresponds to -8.3V/ms 7: corresponds to -8.3V/ms						

R = Readable bit  
W = Writable bit  
U = Unimplemented bit, read as '0'  
- n = Value at POR reset

Figure 36. Tracking Configuration Register TC

### 8.3 Protections

ZY7010L Series converters have a comprehensive set of programmable protections. The set includes the output over- and undervoltage protections, overcurrent protection, overtemperature protection, tracking protection, overtemperature warning, and Power Good signal. Status of protections is stored in the ST register shown in Figure 37.

R-1	R-0	R-1	R-1	R-1	R-1	R-1	R-1
TP	PG	TR	OT	OC	UV	OV	PV
Bit 7				Bit 0			
Bit 7	<b>TP</b> : Temperature Warning						
Bit 6	<b>PG</b> : Power Good Warning						
Bit 5	<b>TR</b> : Tracking Fault						
Bit 4	<b>OT</b> : Overtemperature Fault						
Bit 3	<b>OC</b> : Overcurrent Fault						
Bit 2	<b>UV</b> : Undervoltage Fault						
Bit 1	<b>OV</b> : Overvoltage Error						
Bit 0	<b>PV</b> : Phase Voltage Error						
<b>Note:</b> - An activated warning/fault/error is encoded as '0'							

R = Readable bit  
W = Writable bit  
U = Unimplemented bit, read as '0'  
- n = Value at POR reset

Figure 37. Protection Status Register ST

Thresholds of overcurrent, over- and undervoltage protections, and Power Good limits can be programmed in the GUI Output Configuration window or directly via the I<sup>2</sup>C bus by writing into the CLS and PC2 registers shown in Figure 38 and Figure 39.







R/W-0	R/W-0	R/W-0	R/W-1	R/W-1	R/W-0	R/W-1	R/W-1	
LR2	LR1	LR0	TCE	CLS3	CLS2	CLS1	CLS0	
Bit 7				Bit 0				
Bit 7:5 <b>LR[2:0]</b> : Load regulation configuration 000: 0 V/A/Ohm 001: 0.39 V/A/Ohm 010: 0.78 V/A/Ohm 011: 1.18 V/A/Ohm 100: 1.57 V/A/Ohm 101: 1.96 V/A/Ohm 110: 2.35 V/A/Ohm 111: 2.75 V/A/Ohm								R = Readable bit W = Writable bit U = Unimplemented bit, read as '0' - n = Value at POR reset
Bit 4 <b>TCE</b> , Temperature compensation enable 0: disabled 1: enabled								
Bit 3:0 <b>CLS[3:0]</b> : Current limit setting 0h: corresponds to 37% 1h: corresponds to 47% ... Bh: corresponds to 140% Values higher than Bh are translated to Bh (140%)								

Figure 38. Current Limit Setpoint Register CLS

U	U	U	R/W-0	R/W-1	R/W-0	R/W-0	R/W-0	
---	---	---	PGLL	OVPL1	OVPL0	UVPL1	UVPL0	
Bit 7				Bit 0				
Bit 7:5 <b>Unimplemented</b> , read as '0' Bit 4 <b>PGLL</b> : Set Power Good Low Level 1 = 95% of Vo 0 = 90% of Vo (Default)								R = Readable bit W = Writable bit U = Unimplemented bit, read as '0' - n = Value at POR reset
Bit 3:2 <b>OVPL[1:0]</b> : Set Over Voltage Protection Level 00 = 110% of Vo 01 = 120% of Vo 10 = 130% of Vo (Default) 11 = 130% of Vo								
Bit 1:0 <b>UVPL[1:0]</b> : Set Under Voltage Protection Level 00 = 75% of Vo (Default) 01 = 80% of Vo 10 = 85% of Vo								

Figure 39. Protection Configuration Register PC2

Note that the overvoltage and undervoltage protection thresholds and Power Good limits are defined as percentages of the output voltage. Therefore, the absolute levels of the thresholds change when the output voltage setpoint is changed either by output voltage adjustment or by margining.

In addition, a user can change type of protections (latching or non-latching) or disable certain protections. These settings are programmed in the GUI Fault Management window shown in Figure 40 or directly via the I<sup>2</sup>C by writing into the PC1 register shown in Figure 41.

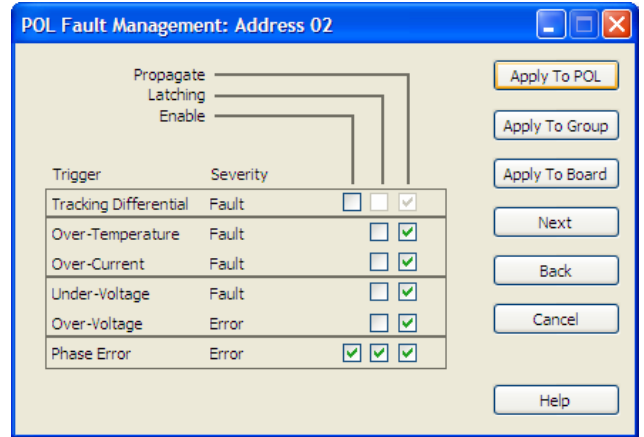

Figure 40. Fault Management Window

R/W-0	R/W-1	R/W-0	R/W-0	R/W-0	R/W-0	R/W-1	R/W-1	
TRE	PVE	TRP	OTP	OCP	UVP	OVP	PVP	
Bit 7				Bit 0				
Bit 7 <b>TRE</b> : Tracking fault enable 1 = enabled 0 = disabled								R = Readable bit W = Writable bit U = Unimplemented bit, read as '0' - n = Value at POR reset
Bit 6 <b>PVE</b> : Phase voltage error enable 1 = enabled 0 = disabled								
Bit 5 <b>TRP</b> : Tracking fault protection 1 = latching 0 = non latching								
Bit 4 <b>OTP</b> : Overtemperature protection configuration 1 = latching 0 = non latching								
Bit 3 <b>OCP</b> : Overcurrent protection configuration 1 = latching 0 = non latching								
Bit 2 <b>UVP</b> : Undervoltage protection configuration 1 = latching 0 = non latching								
Bit 1 <b>OVP</b> : Overvoltage protection configuration 1 = latching 0 = non latching								
Bit 0 <b>PVP</b> : Phase Voltage Protection 1 = latching 0 = non latching								

Figure 41. Protection Configuration Register PC1

If the non-latching protection is selected, a POL will attempt to restart every 130ms until the condition that triggered the protection is removed. When restarting, the output voltages follow tracking and sequencing settings.

If the latching type is selected, a POL will turn off and stay off. The POL can be turned on after 130ms, if the condition that caused the fault is removed and the respective bit in the ST register was cleared, or the Turn On command was recycled, or the input voltage was recycled.





All protections can be classified into three groups based on their effect on system operation: warnings, faults, and errors.

### 8.3.1 Warnings

This group includes Overtemperature Warning and Power Good Signal. The warnings do not turn off POLs but rather generate signals that can be transmitted to a host controller via the I<sup>2</sup>C bus.

#### 8.3.1.1 Overtemperature Warning

The Overtemperature Warning is generated when temperature of the controller exceeds 120°C. The Overtemperature Warning changes the PT bit of the status register ST to 0 and sends the signal to the DPM. Reporting is enabled in the GUI Fault Management window or directly via the I<sup>2</sup>C by writing into the PC3 register shown in Figure 43. When the temperature falls below 117°C, the PT bit is cleared and the Overtemperature Warning is removed.

#### 8.3.1.2 Power Good

Power Good is an open collector output that is pulled low, if the output voltage is outside of the Power Good window. The window is formed by the Power Good High threshold that is equal to 110% of the output voltage and the Power Good Low threshold that can be programmed at 90 or 95% of the output voltage.

The Power Good protection is only enabled after the output voltage reaches its steady state level. The PGOOD pin is pulled low during transitions of the output voltage from one level to other as shown in Figure 42.

The Power Good Warning pulls the Power Good pin low and changes the PG bit of the status register ST to 0. It sends the signal to the DPM, if the reporting is enabled. When the output voltage returns within the Power Good window, the PG pin is pulled high, the PG bit is cleared and the Power Good Warning is removed. The Power Good pin can also be pulled low by an external circuit to initiate the Power Good Warning.

**Note:** To retrieve status information, Status Monitoring in the GUI POL Group Configuration Window should be enabled (refer to Digital Power Manager Data Sheet). The DPM will retrieve the status information from each POL on a continuous basis.

### 8.3.2 Faults

This group includes overcurrent, overtemperature, undervoltage, and tracking protections. Triggering any protection in this group will turn off the POL.

#### 8.3.2.1 Overcurrent Protection

Overcurrent protection is active whenever the output voltage of the POL exceeds the prebias voltage (if any). When the output current reaches the OC threshold, the output voltage will start decreasing. As soon as the output voltage decreases below the undervoltage protection threshold, the OC fault signal is generated, the POL turns off and the OC bit in the register ST is changed to 0. Both high side and low side switches of the POL are turned off instantly (fast turn-off).

The temperature compensation is added to keep the OC threshold approximately constant at temperatures above room temperature. Note that the temperature compensation can be disabled in the GUI Output Configuration window or directly via the I<sup>2</sup>C by writing into the CLS register. However, it is recommended to keep the temperature compensation enabled.

#### 8.3.2.2 Undervoltage Protection

The undervoltage protection is only active during steady state operation of the POL to prevent nuisance tripping. If the output voltage decreases below the UV threshold and there is no OC fault, the UV fault signal is generated, the POL turns off, and the UV bit in the register ST is changed to 0. The output voltage is ramped down according to sequencing and tracking settings (regular turn-off).

#### 8.3.2.3 Overtemperature Protection

Overtemperature protection is active whenever the POL is powered up. If temperature of the controller exceeds 130°C, the OT fault is generated, POL turns off, and the OT bit in the register ST is changed to 0. The output voltage is ramped down according to sequencing and tracking settings (regular turn-off).

If non-latching OTP is programmed, the POL will restart as soon as the temperature of the controller decreases below the Overtemperature Warning threshold of 120°C.





### 8.3.2.4 Tracking Protection

Tracking protection is active only when the output voltage is ramping up. The purpose of the protection is to ensure that the voltage differential between multiple rails being tracked does not exceed 250mV. This protection eliminates the need for external clamping diodes between different voltage rails which are frequently recommended by ASIC manufacturers.

When the tracking protection is enabled, the POL continuously compares actual value of the output voltage to its programmed value as defined by the output voltage and its rising slew rate. If absolute

value of the difference exceeds 250mV, the tracking fault signal is generated, the POL turns off, and the TR bit in the register ST is changed to 0. Both high side and low side switches of the POL are turned off instantly (fast turn-off).

The tracking protection can be disabled, if it contradicts requirements of a particular system (for example turning into high capacitive load where rising slew rate is not important). It can be disabled in the GUI Fault Management window or directly via the I<sup>2</sup>C bus by writing into the PC1 register.

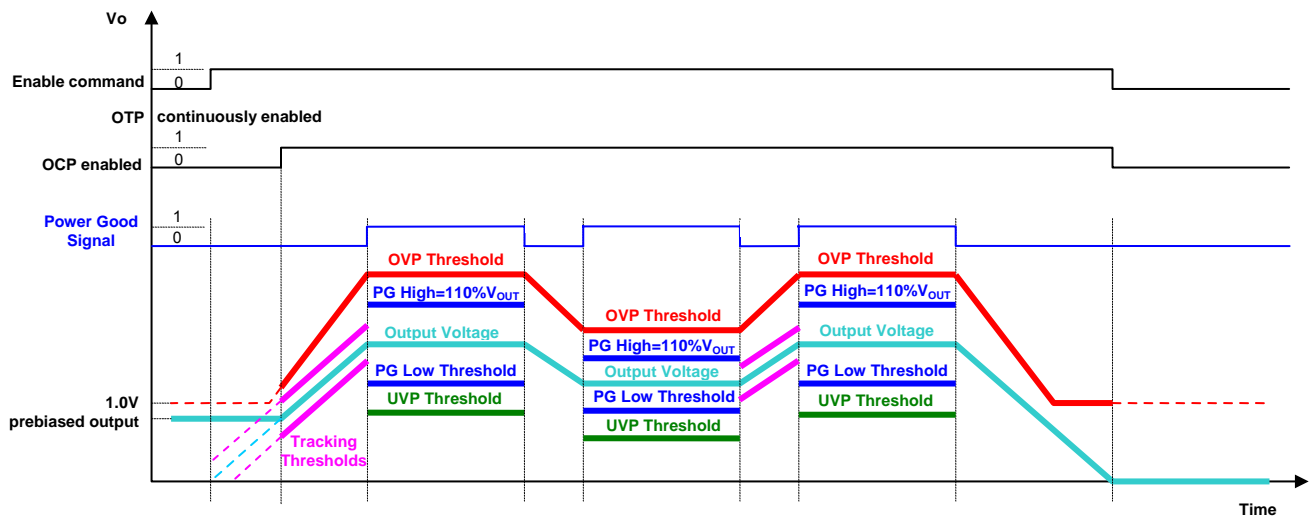

Figure 42. Protections Enable Conditions

### 8.3.3 Errors

The group includes overvoltage protection and the phase voltage error. The phase voltage error is not available in ZY7010L.

#### 8.3.3.1 Overvoltage Protection

The overvoltage protection is active whenever the output voltage of the POL exceeds the pre-bias voltage (if any). If the output voltage exceeds the overvoltage protection threshold, the overvoltage error signal is generated, the POL turns off, and the OV bit in the register ST is changed to 0. The high side switch is turned off instantly, and simultaneously the low side switch is turned on to ensure reliable protection of sensitive loads. The low side switch provides low impedance path to quickly dissipate

energy stored in the output filter and achieve effective voltage limitation.

The OV threshold can be programmed from 110% to 130% of the output voltage setpoint, but not lower than 1.0V.

#### 8.3.4 Faults and Errors Propagation

The feature adds flexibility to the fault management scheme by giving users control over propagation of fault signals within and outside of the system. The propagation means that a fault in one POL can be programmed to turn off other POLs and devices in the system, even if they are not directly affected by the fault.



### 8.3.4.1 Grouping of POLs

Z-Series POLs can be arranged in several groups to simplify fault management. A group of POLs is defined as a number of POLs with interconnected OK pins. A group can include from 1 to 32 POLs. If fault propagation within a group is desired, the propagation bit needs to be checked in the GUI Fault Management Window. The parameters can also be programmed directly via the I<sup>2</sup>C bus by writing into the PC3 register shown in Figure 43.

When propagation is enabled, the faulty POL pulls its OK pin low. A low OK line initiates turn-off of other POLs in the group.

R/W-0	R/W-0	R/W-1	R/W-1	R/W-1	R/W-1	R/W-1	R/W-1
PTM	PGM	TRP	OTP	OCF	UVP	OVP	PVP
Bit 7				Bit 0			
Bit 7	<b>PTM:</b> Temperature warning Message 1 = enabled 0 = disabled			R = Readable bit W = Writable bit U = Unimplemented bit, read as '0' - n = Value at POR reset			
Bit 6	<b>PGM:</b> Power good message 1 = enabled 0 = disabled						
Bit 5	<b>TRP:</b> Tracking fault propagation 1 = enabled 0 = disabled						
Bit 4	<b>OTP:</b> Overtemperature fault propagation 1 = enabled 0 = disabled						
Bit 3	<b>OCF:</b> Overcurrent fault propagation 1 = enabled 0 = disabled						
Bit 2	<b>UVP:</b> Undervoltage fault propagation 1 = enabled 0 = disabled						
Bit 1	<b>OVP:</b> Overvoltage error propagation 1 = enabled 0 = disabled						
Bit 0	<b>PVP:</b> Phase voltage error propagation 1 = enabled 0 = disabled						

Figure 43. Protection Configuration Register PC3

In addition, the OK lines can be connected to the DPM to facilitate propagation of faults and errors between groups. One DPM can control up to 4 independent groups. To enable fault propagation between groups, the respective bit needs to be checked in the GUI Fault and Error Propagation window shown in Figure 44.

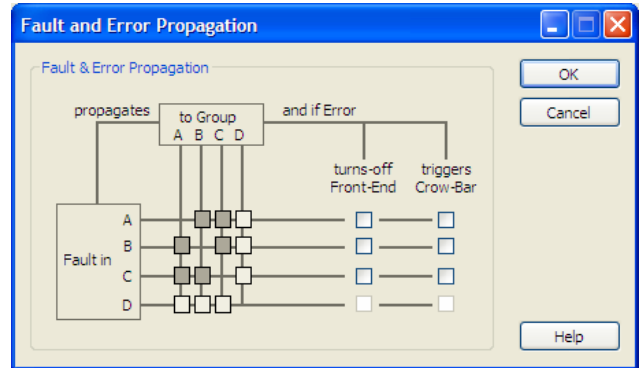

Figure 44. Fault and Error Propagation Window

In this case low OK line will signal DPM to pull other OK lines low to initiate shutdown of other POLs as programmed in the GUI Fault and Error Propagation window. If an error is propagated, the DPM can also generate commands to turn off a front end (a DC-DC converter generating the intermediate bus voltage) and trigger an optional crowbar protection to accelerate removal of the IBV voltage.

### 8.3.4.2 Propagation Process

Propagation of a fault (OCF, UVP, OTP, and TRP) initiates regular turn-off of other POLs. The faulty POL in this case performs either the regular or the fast turn-off depending on a specific fault as described in section 8.3.2.

Propagation of an error initiates fast turn-off of other POLs. The faulty POL performs the fast turn-off and turns on its low side switch.

Example of the fault propagation is shown in Figure 45 - Figure 46. In this three-output system (refer to the block diagram in Figure 25), the POL powering the output V3 (Ch 1 in the picture) encounters the undervoltage fault after the turn-on. When the fault propagation is not enabled, the POL turns off and generates the UV fault signal. Because the UV fault triggers the regular turn off, the POL meets its turn-off delay and falling slew rate settings during the turn-off process as shown in Figure 45. Since the UV fault is programmed to be non-latching, the POL will attempt to restart every 130ms, repeating the process described above until the condition causing the undervoltage is removed.

If the fault propagation between groups is enabled, the POL powering the output V3 pulls its OK line low and the DPM propagates the signal to the POL powering the output V1 that belongs to other group.





The POL powering the output V1 (Ch3 in the picture) executes the regular turn-off. Since both V1 and V3 have the same delay and slew rate settings they will continue to turn off and on synchronously every 130ms as shown in Figure 46 until the condition causing the undervoltage is removed. The POL powering the output V2 continues to ramp up until it reaches its steady state level.

130ms is the interval from the instant of time when the output voltage ramps down to zero until the output voltage starts to ramp up again. Therefore, the 130ms hiccup interval is guaranteed regardless of the turn-off delay setting.

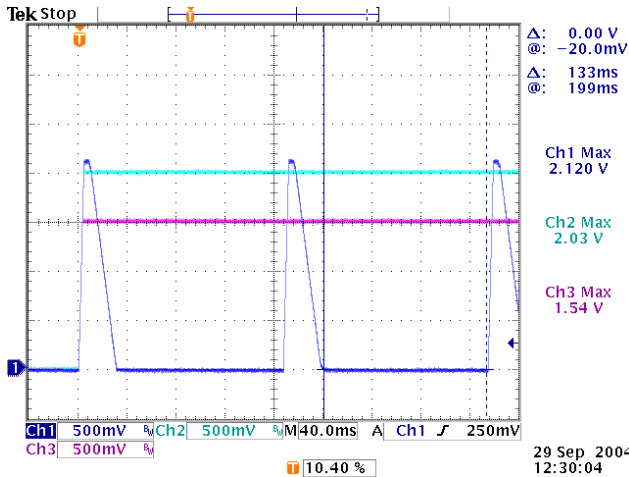

Figure 45. Turn-On into UVP on V3. The UV Fault Is Programmed To Be Non-Latching. Ch1 – V3 (Group C), Ch2 – V2, Ch3 – V1 (Group A)

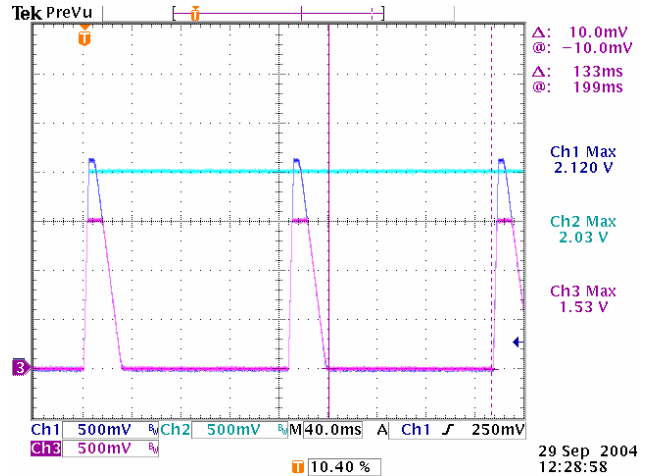

Figure 46. Turn-On into UVP on V3. The UV Fault Is Programmed To Be Non-Latching and Propagate From Group C to Group A. Ch1 – V3 (Group C), Ch2 – V2, Ch3 – V1 (Group A)

Summary of protections, their parameters and features are shown in Table 3

Table 3. Summary of Protections Parameters and Features

Code	Name	Type	When Active	Turn Off	Low Side Switch	Propagation	Disable
PT	Temperature Warning	Warning	Whenever $V_{IN}$ is applied	No	N/A	Sends signal to DPM	No
PG	Power Good	Warning	During steady state	No	N/A	Sends signal to DPM	No
TR	Tracking	Fault	During ramp up	Fast	Off	Regular turn off	Yes
OT	Overtemperature	Fault	Whenever $V_{IN}$ is applied	Regular	Off	Regular turn off	No
OC	Overcurrent	Fault	When $V_{OUT}$ exceeds prebias	Fast	Off	Regular turn off	No
UV	Undervoltage	Fault	During steady state	Regular	Off	Regular turn off	No
OV	Overvoltage	Error	When $V_{OUT}$ exceeds prebias	Fast	On	Fast turn off	No





### 8.4 PWM Parameters

Z-Series POLs utilize the digital PWM controller. The controller enables users to program most of the PWM performance parameters, such as switching frequency, interleave, duty cycle, and feedback loop compensation.

#### 8.4.1 Switching Frequency

The switching frequency can be programmed in the GUI PWM Controller window shown in Figure 47 or directly via the I<sup>2</sup>C bus by writing into the INT register shown in Figure 48. Note that the content of the register can be changed only when the POL is turned off.

Switching actions of all POLs connected to the SD line are synchronized to the master clock generated by the DPM. Each POL is equipped with a PLL and a frequency divider so they can operate at multiples (including fractional) of the master clock frequency as programmed by a user. The POL converters can operate at 500 kHz, 750 kHz, and 1 MHz. Although synchronized, switching frequencies of different POLs are independent of each other. It is permissible to mix POLs operating at different frequencies in one system. It allows optimizing efficiency and transient response of each POL in the system individually.

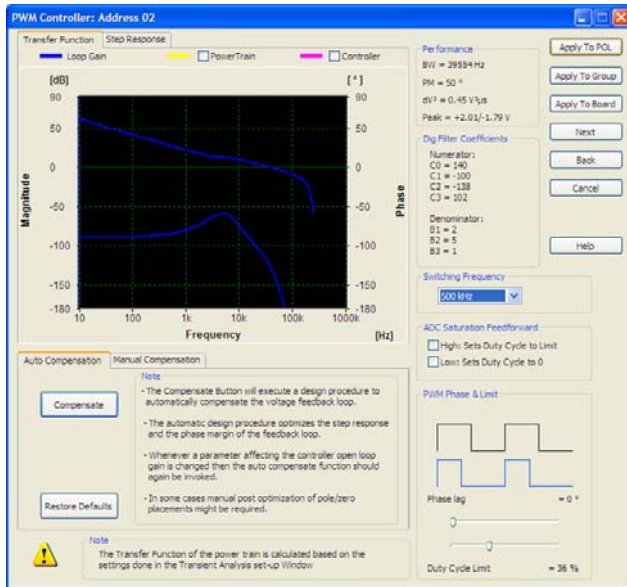

Figure 47. PWM Controller Window

R/W-0	R/W-0	R/W-0	R/W-0 <sup>1)</sup>	R/W-0 <sup>1)</sup>	R/W-0 <sup>1)</sup>	R/W-0 <sup>1)</sup>	R/W-0 <sup>1)</sup>	
FRQ2	FRQ1	FRQ0	INT4	INT3	INT2	INT1	INT0	
Bit 7							Bit 0	
Bit 7:5 <b>FRQ[2:0]</b> : PWM Frequency Selection 000: 500kHz 001: 750kHz 010: 1000kHz 011: 1250kHz 100: 1250kHz 101: 1500kHz 110: 1750kHz 111: 2000kHz								R = Readable bit W = Writable bit U = Unimplemented bit, read as '0' - n = Value at POR reset
Bit 4:0 <b>INT[4:0]</b> : Interleave position 00h: Ton starts with 0.0° Phase lag to SD Line 01h: Ton starts with 11.25° Phase lag to SD Line 02h: Ton starts with 22.50° Phase lag to SD Line ... 1Fh: Ton starts with 348.75° Phase lag to SD Line								
<sup>1)</sup> Initial value depends on the state of the Interleave Mode ( <b>IM</b> ) Input: IM=Open: At POR reset the 5 corresponding ADDRESS bits are loaded IM=Low: At POR reset a 0 is loaded								

Figure 48. Interleave Configuration Register INT

#### 8.4.2 Interleave

Interleave is defined as a phase delay between the synchronizing slope of the master clock on the SD pin and PWM signal of a POL. The interleave can be programmed in the GUI PWM Controller window or directly via the I<sup>2</sup>C bus by writing into the INT register.

Every POL generates switching noise. If no interleave is programmed, all POLs in the system switch simultaneously and noise reflected to the input source from all POLs is added together as shown in Figure 49.

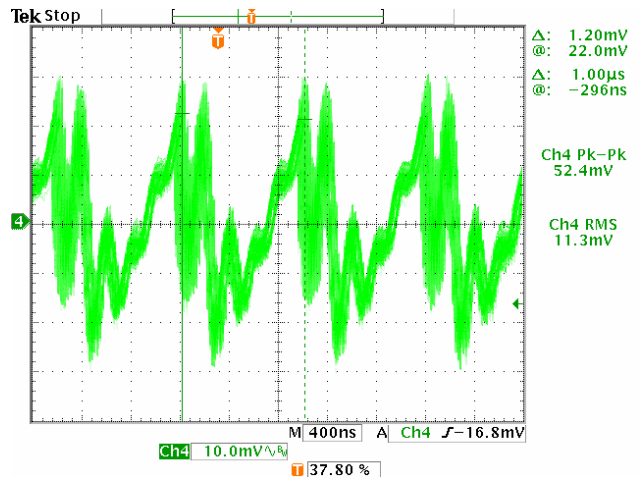

Figure 49. Input Voltage Noise, No Interleave







Figure 50 shows the input voltage noise of the three-output system with programmed interleave. Instead of all three POLs switching at the same time as in the previous example, the POLs V1, V2, and V3 switch at 67.5°, 180°, and 303.75°, respectively. Noise is spread evenly across the switching cycle resulting in more than 1.5 times reduction. To achieve similar noise reduction without the interleave will require the addition of an external LC filter.

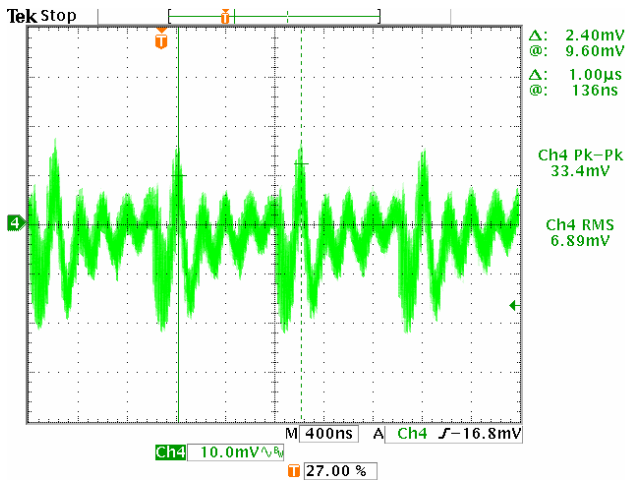

Figure 50. Input Voltage Noise with Interleave

Similar noise reduction can be achieved on the output of POLs connected in parallel. Figure 51 and Figure 52 show the output noise of two ZY7010Ls connected in parallel without and with 180° interleave, respectively. Resulting noise reduction is more than 2 times and is equivalent to doubling switching frequency or adding extra capacitance on the output of the POLs.

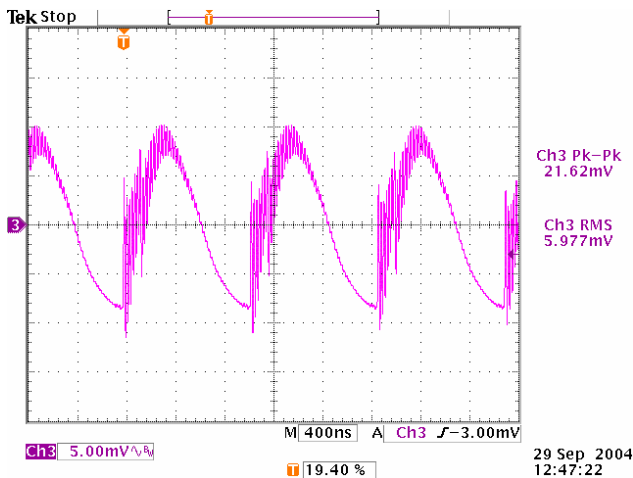

Figure 51. Output Voltage Noise, Full Load, No Interleave

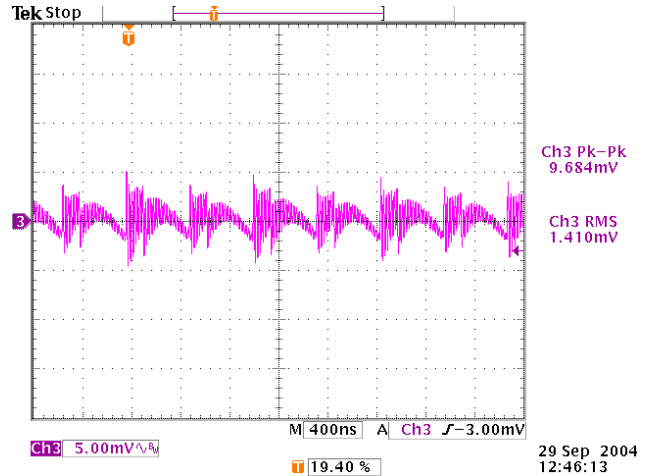

Figure 52. Output Voltage Noise, Full Load, 180° Interleave

The ZY7010L interleave feature is similar to that of multiphase converters, however, unlike in the case of multiphase converters, interleave does not have to be equal to 360/N, where N is the number of POLs in a system. ZY7010L interleave is independent of the number of POLs in a system and is fully programmable in 11.25° steps. It allows maximum output noise reduction by intelligently spreading switching energy.

**Note:** Due to noise sensitivity issues that may occur in limited cases, it is recommended to avoid phase lag settings of 112.5 and 123.75 degrees, otherwise false PG and/or OV indications may occur.

### 8.4.3 Duty Cycle Limit

The ZY7010L is a step-down converter therefore  $V_{OUT}$  is always less than  $V_{IN}$ . The relationship between the two parameters is characterized by the duty cycle and can be estimated from the following equation:

$$DC = \frac{V_{OUT}}{V_{IN.MIN}}$$

Where, DC is the duty cycle,  $V_{OUT}$  is the required maximum output voltage (including margining),  $V_{IN.MIN}$  is the minimum input voltage.

It is good practice to limit the maximum duty cycle of the PWM controller to a somewhat higher value compared to the steady-state duty cycle as expressed by the above equation. This will further protect the output from excessive voltages. The duty cycle limit can be programmed in the GUI PWM Controller window or directly via the I<sup>2</sup>C bus by writing into the DCL register shown in Figure 53.





R/W-1	R/W-1	R/W-1	R/W-0	R/W-1	R/W-0	R/W-0	R/W-0
DCL5	DCL4	DCL3	DCL2	DCL1	DCL0	HI	LO
Bit 7						Bit 0	
Bit 7:2 <b>DCL[5:0]</b> , Duty Cycle Limitation 00h: 0 01h: 1/64 ... 3Fh: 63/64							
Bit 1: <b>HI</b> , ADC high saturation feed-forward 0: disabled 1: enabled							
Bit 0: <b>LO</b> , ADC low saturation feed-forward 0: disabled 1: enabled							

R = Readable bit  
 W = Writable bit  
 U = Unimplemented bit, read as '0'  
 - n = Value at POR reset

Figure 53. Duty Cycle Limit Register

### 8.4.4 ADC Saturation Feedforward

To speed up the PWM response in case of heavy dynamic loads, the duty cycle can be forced either to 0 or the duty cycle limit depending on the polarity of the transient. This function is equivalent to having two comparators defining a window around the output voltage setpoint. When an error signal is inside the window, it will produce gradual duty cycle change proportional to the error signal. If the error signal goes outside the window (usually due to large output current steps), the duty cycle will change to its limit in one switching cycle. In most cases this will significantly improve transient response of the controller, reducing amount of required external capacitance.

Under certain circumstances, usually when the maximum duty cycle limit significantly exceeds its nominal value, the ADC saturation can lead to the overcompensation of the output error. The phenomenon manifests itself as low frequency oscillations on the output of the POL. It can usually be reduced or eliminated by disabling the ADC saturation or limiting the maximum duty cycle to 120-140% of the calculated value. It is not recommended to use ADC saturation for output voltages higher than 2.0V.

The ADC saturation feedforward can be programmed in the GUI PWM Controller window or directly via the I<sup>2</sup>C bus by writing into the DCL register.

### 8.4.5 Feedback Loop Compensation

Feedback loop compensation can be programmed in the GUI PWM Controller window by setting frequency of poles and zeros of the transfer function.

The transfer function of the POL converter is shown in Figure 54. It is a third order function with two zeros and three poles. Pole 1 is the integrator pole, Pole 2 is used in conjunction with Zero 1 and Zero 2 to adjust the phase lead and limit the gain increase in mid band. Pole 3 is used as a high frequency low-pass filter to limit PWM noise.

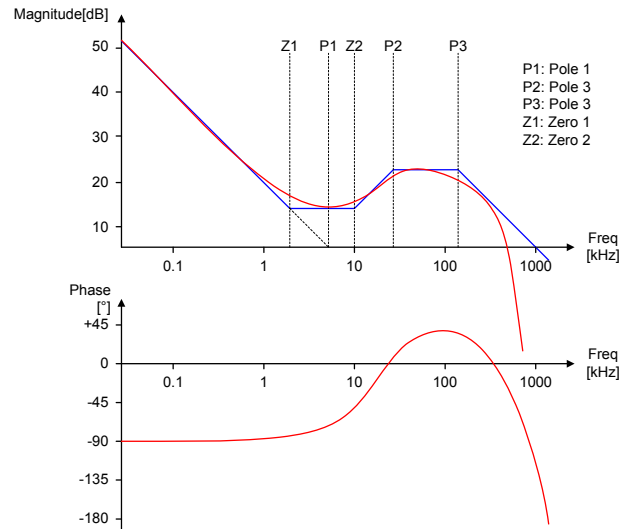

Figure 54. Transfer Function of PWM

Positions of poles and zeroes are determined by coefficients of the digital filter. The filter is characterized by four numerator coefficients ( $C_0, C_1, C_2, C_3$ ) and three denominator coefficients ( $B_1, B_2, B_3$ ). The coefficients are automatically calculated when desired frequency of poles and zeros is entered in the GUI PWM Controller window. The coefficients are stored in the C0H, C0L, C1H, C1L, C2H, C2L, C3H, C3L, B1, B2, and B3 registers.

**Note:** The GUI automatically transforms zero and pole frequencies into the digital filter coefficients. It is strongly recommended to use the GUI to determine the filter coefficients.

Programming feedback loop compensation allows optimizing POL performance for various application conditions. For example, increase in bandwidth can significantly improve dynamic response.

### 8.5 Current Share

The POL converters are equipped with the digital current share function. To activate the current share, interconnect the CS pins of the POLs connected in





parallel. The digital signal transmitted over the CS line sets output currents of all POLs to the same level.

When POLs are connected in parallel, they must be included in the same parallel bus in the GUI System Configuration window shown in Figure 55. In this case, the GUI automatically copies parameters of one POL onto all POLs connected to the parallel bus. It makes it impossible to configure different performance parameters for POLs connected in parallel except for interleave and load regulation settings that are independent. The interleave allows to reduce and move the output noise of the converters connected in parallel to higher frequencies as shown in Figure 51 and Figure 52. The load regulation allows controlling the current share loop gain in case of small signal oscillations. It is recommended to always add a small amount of load regulation to one of the converters connected in parallel to reduce loop gain and therefore improve stability.

### **8.6 Performance Parameters Monitoring**

The POL converters can monitor their own performance parameters such as output voltage, output current, and temperature.

The output voltage is measured at the output sense pins, output current is measured using the ESR of the output inductor and temperature is measured by the thermal sensor built into the controller IC. Output current readings are adjusted based on temperature readings to compensate for the change of ESR of the inductor with temperature.

An 8-Bit Analog to Digital Converter (ADC) converts the output voltage, output current, and temperature into a digital signal to be transmitted via the serial interface. The ADC allows a minimum sampling frequency of 1 kHz for all three values.

Monitored parameters are stored in registers (VOM, IOM, and TMON) that are continuously updated. If the Retrieve Monitoring bits in the GUI Group Configuration window shown in Figure 56 are checked, those registers are being copied into the ring buffer located in the DPM. Contents of the ring buffer can be displayed in the GUI IBS Monitoring Window shown in Figure 57 or it can be read directly via the I<sup>2</sup>C bus using high and low level commands as described in the “DPM Programming Manual”.





ZY7010L 10A DC-DC Intelligent POL Data Sheet  
 3V to 13.2V Input • 0.5V to 5.5V Output



System Configuration - ZM7300Demo.p1c

File: Save Config..., Load Config..., Generate SVF...

System: Program Config..., Read Config..., Edit User Mem..., Operate..., Gen Spec Sheet, Intro Window, Help

Z-ONE Power System

**DPH**

Type: ZM7332AA

Interrupted ■ ← I2C

	Write Protect		Interrupts	
	<b>Enabled</b>		Fault Propagation	
			Intermediate Bus	

Address	00	01	02	03	04	05	06	07	08	09	10	11	12	13	14	15	16	17	18	19	20	21	22	23	24	25	26	27	28	29	30	31
Group A	■	■																														
Group B			■																													
Group C				■																												
Group D																																
Voltage	1.800V	1.800V	2.100V	Pin 05																												
Single POL			■																													
Parallel Bus 1	■	■																														
Parallel Bus 2																																
Parallel Bus 3																																
Parallel Bus 4																																
Parallel Bus 5																																
Parallel Bus 6																																
Parallel Bus 7																																
Parallel Bus 8																																

System contains 3 POLs, 1 aux devices      Intermediate Bus = 12.0V +10% -10%

Figure 55. GUI System Configuration Window



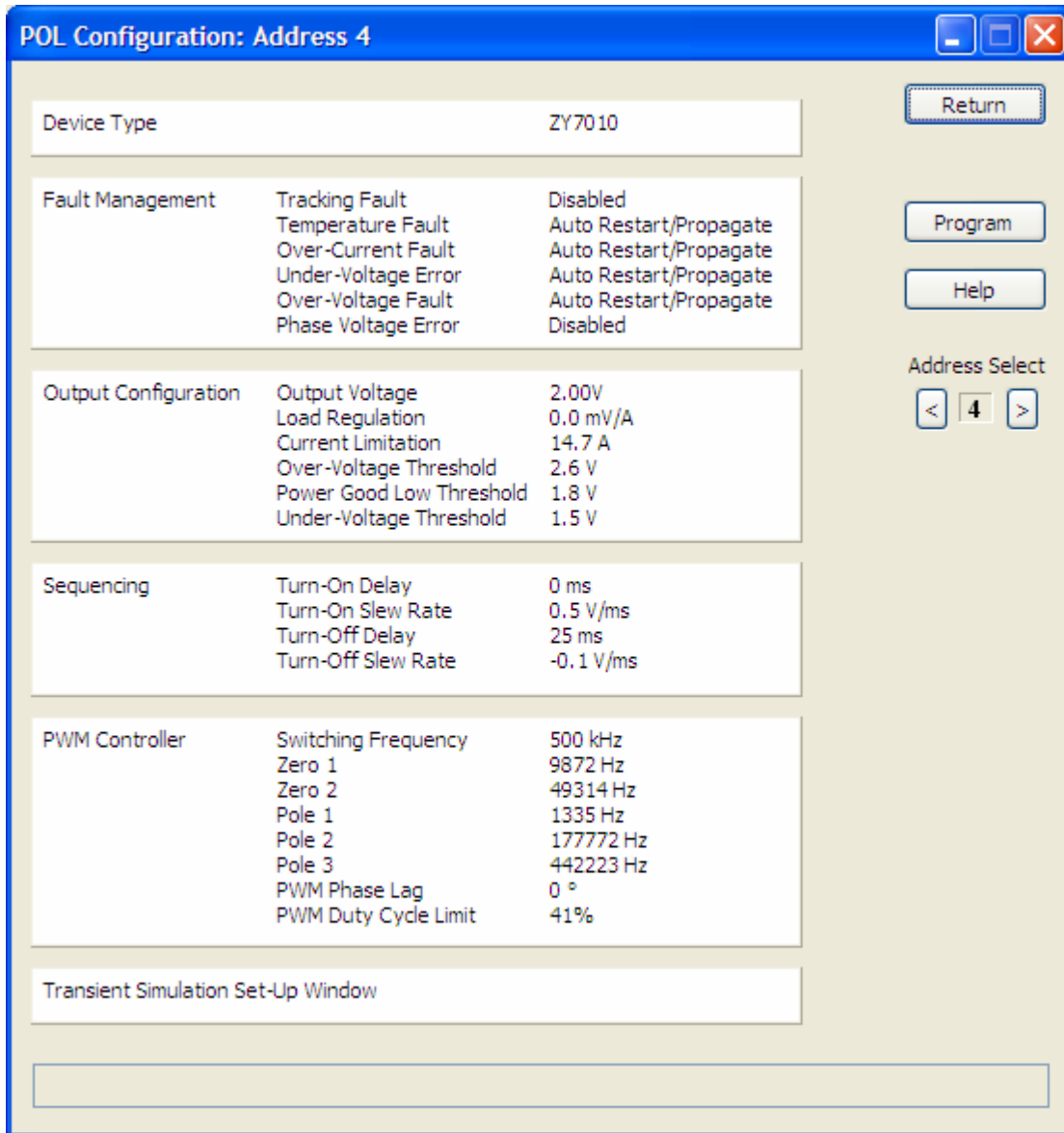

Figure 56. POL Group Configuration Window

## 9. Safety

The ZY7010L POL converters **do not provide isolation** from input to output. The input devices powering ZY7010L must provide relevant isolation requirements according to all IEC60950 based standards. Nevertheless, if the system using the converter needs to receive safety agency approval, certain rules must be followed in the design of the system. In particular, all of the creepage and clearance requirements of the end-use safety

requirements must be observed. These requirements are included in UL60950 - CSA60950-00 and EN60950, although specific applications may have other or additional requirements.

The ZY7010L POL converters have no internal fuse. If required, the external fuse needs to be provided to protect the converter from catastrophic failure. Refer to the “Input Fuse Selection for DC/DC converters” application note on [www.power-one.com](http://www.power-one.com) for proper selection of the input fuse. Both input traces and the



chassis ground trace (if applicable) must be capable of conducting a current of 1.5 times the value of the fuse without opening. The fuse must not be placed in the grounded input line.

Abnormal and component failure tests were conducted with the POL input protected by a fast-acting 65 V, 15 A, fuse. If a fuse rated greater than

15 A is used, additional testing may be required.

In order for the output of the ZY7010L POL converter to be considered as SELV (Safety Extra Low Voltage), according to all IEC60950 based standards, the input to the POL needs to be supplied by an isolated secondary source providing a SELV also.

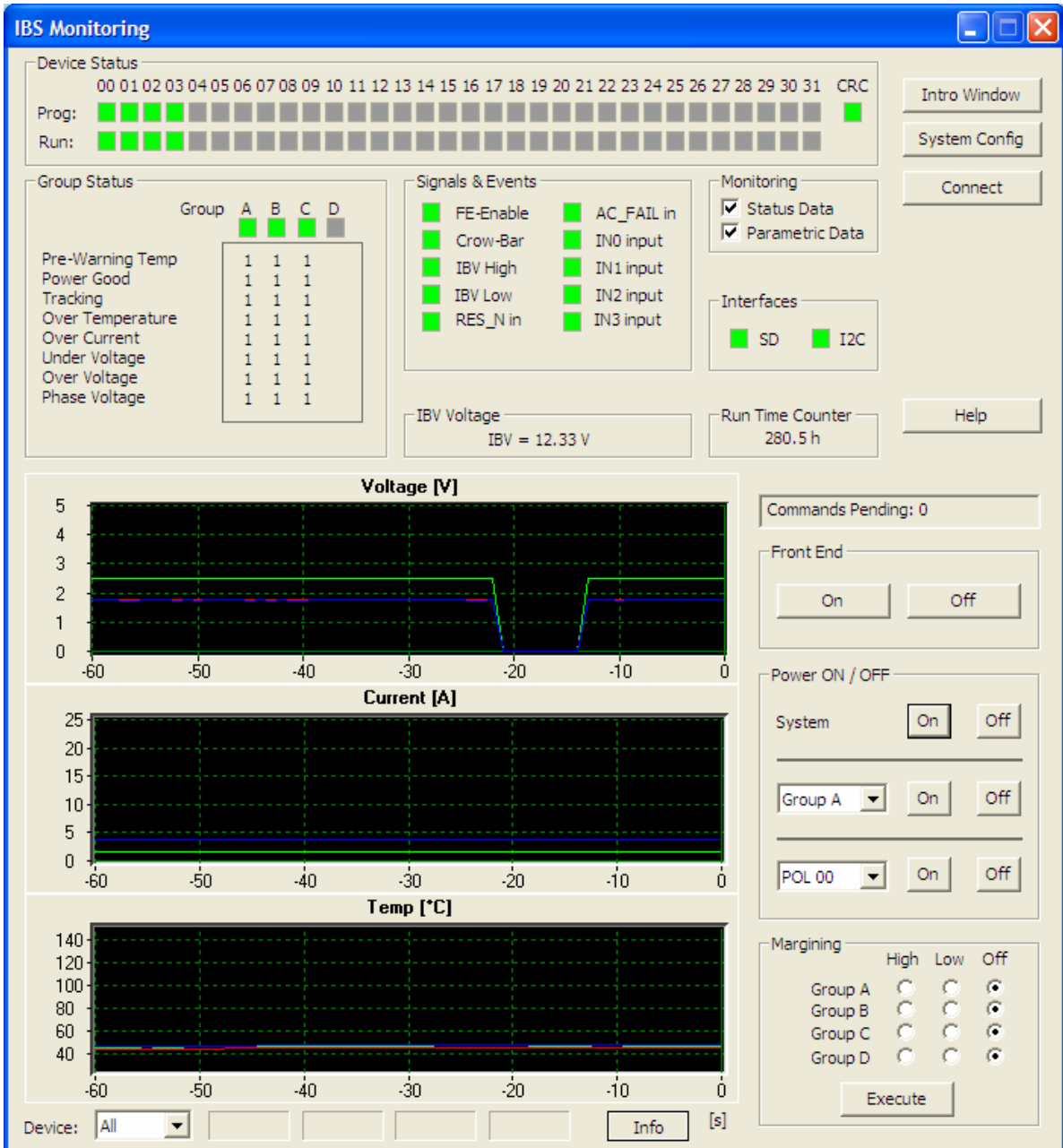

Figure 57. IBS Monitoring Window

10. Mechanical Drawings

All Dimensions are in mm

Tolerances:

0.5-10 ±0.1

10-100 ±0.2

Pin Coplanarity: 0.1 max

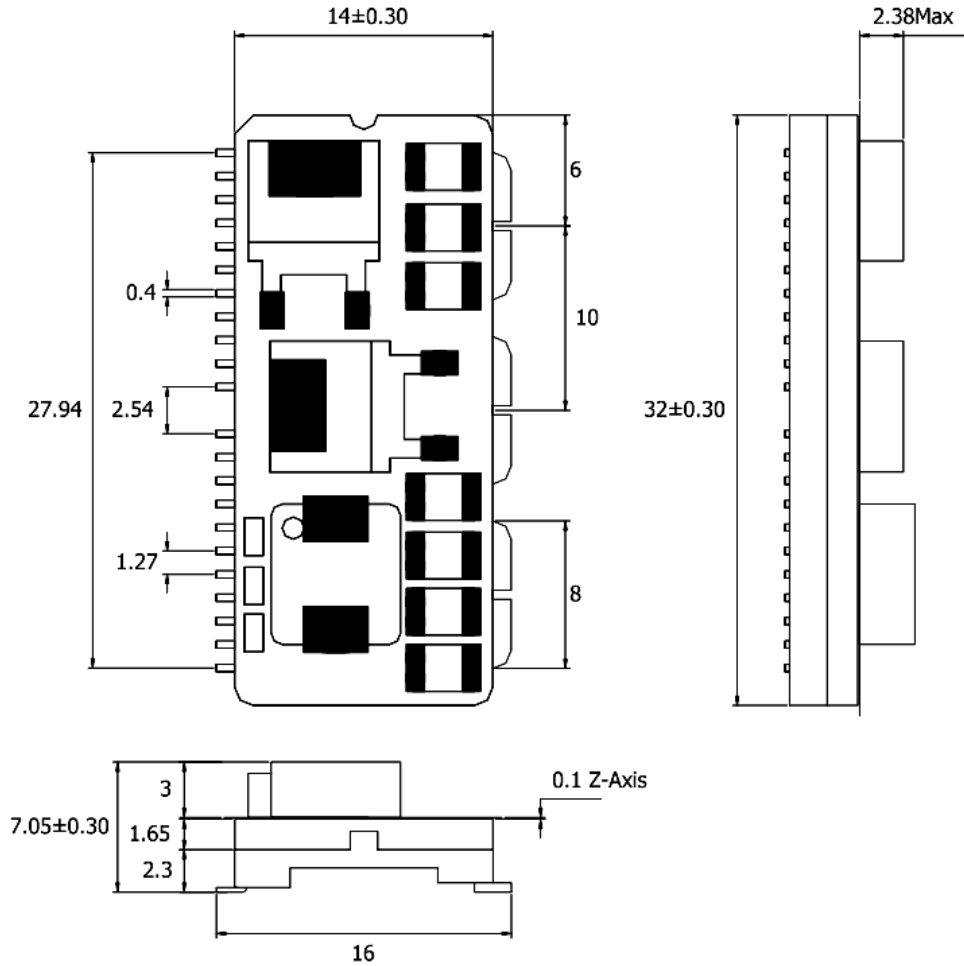

Figure 58. Mechanical Drawing

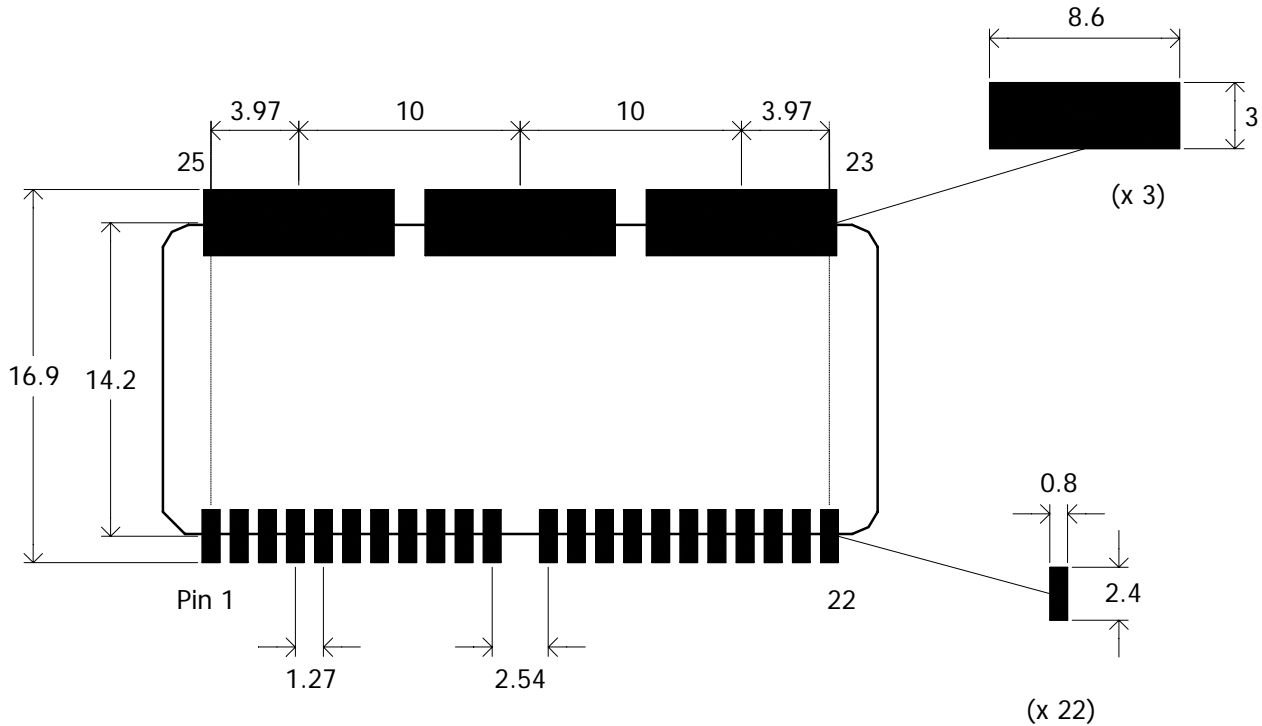
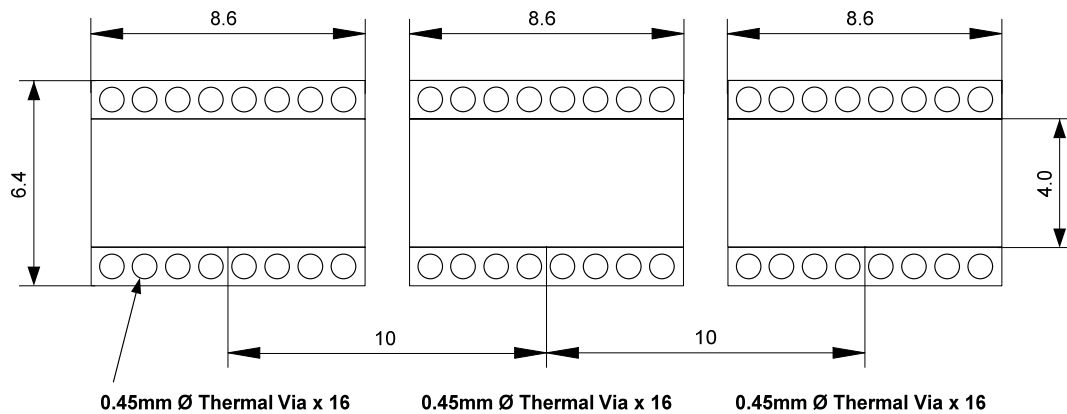

Figure 59. Recommended Pad Sizes



Recommended via diameter is 0.45mm Barrel wall plating of > 25um Pitch < 1.00mm

Figure 60. Recommended PCB Layout for Multilayer PCBs

**Notes:**

1. NUCLEAR AND MEDICAL APPLICATIONS - Power-One products are not designed, intended for use in, or authorized for use as critical components in life support systems, equipment used in hazardous environments, or nuclear control systems without the express written consent of the respective divisional president of Power-One, Inc.
2. TECHNICAL REVISIONS - The appearance of products, including safety agency certifications pictured on labels, may change depending on the date manufactured. Specifications are subject to change without notice.

I<sup>2</sup>C is a trademark of Philips Corporation.