

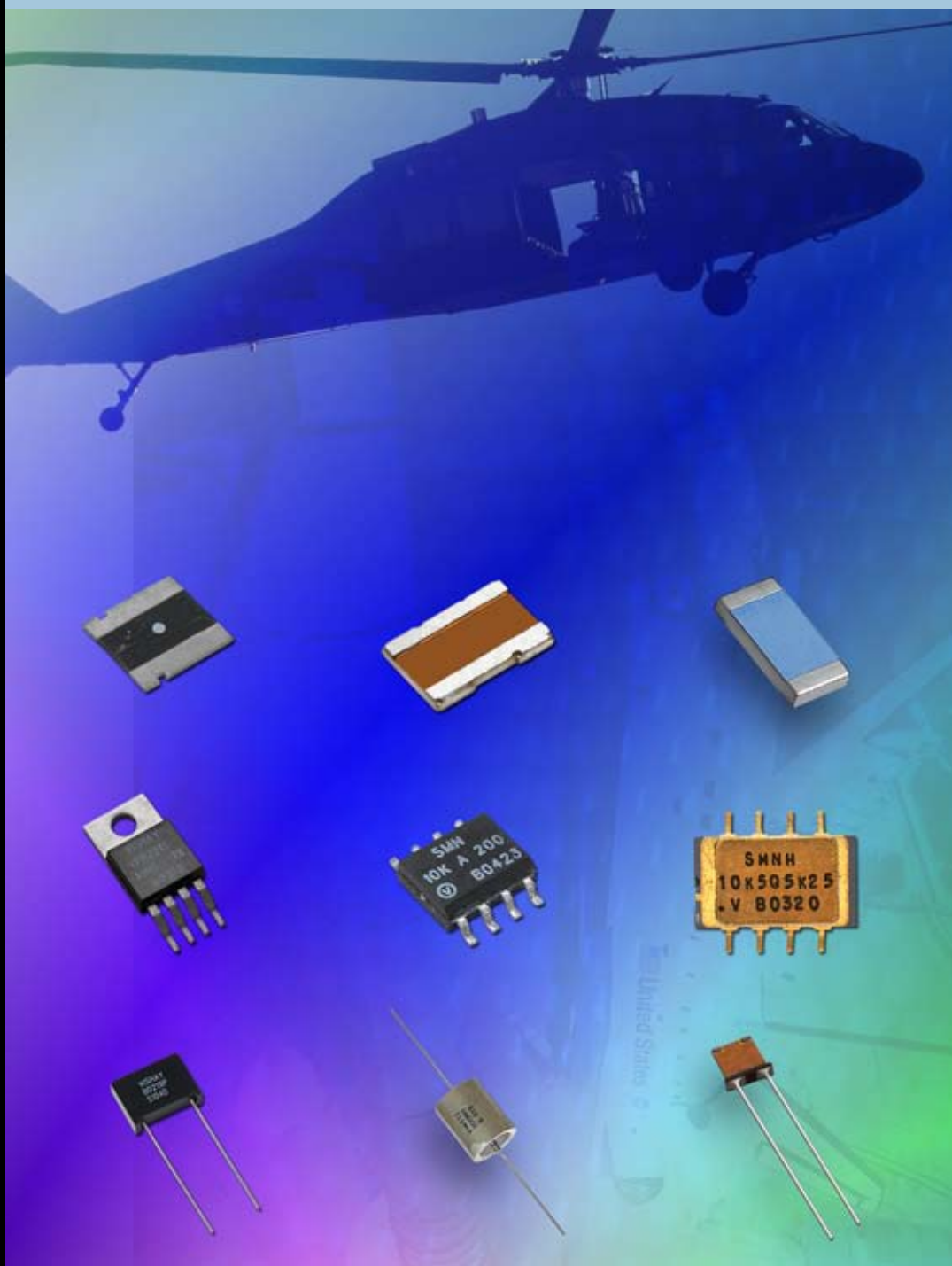


VISHAY INTERTECHNOLOGY, INC.

BULK METAL® FOIL

# BULK METAL® FOIL RESISTORS COMPLETE RESOURCE GUIDE

2008 EDITION



## SEMICONDUCTORS

### RECTIFIERS

Schottky (single, dual)  
 Standard, Fast, and Ultra-Fast Recovery  
 (single, dual)  
 Bridge  
 Superrectifier®  
 Sinterglass Avalanche Diodes

### HIGH-POWER DIODES AND THYRISTORS

High-Power Fast-Recovery Diodes  
 Phase-Control Thyristors  
 Fast Thyristors

### SMALL-SIGNAL DIODES

Schottky and Switching (single, dual)  
 Tuner/Capacitance (single, dual)  
 Bandswitching  
 PIN

### ZENER AND SUPPRESSOR DIODES

Zener (single, dual)  
 TVS (TRANSZORB®, Automotive, ESD, Arrays)

### FETs

Low-Voltage TrenchFET® Power MOSFETs  
 High-Voltage TrenchFET® Power MOSFETs  
 High-Voltage Planar MOSFETs  
 JFETs

### RF TRANSISTORS

Bipolar Transistors (AF and RF)  
 Dual Gate MOSFETs  
 MOSMICs®

### OPTOELECTRONICS

IR Emitters and Detectors,  
 and IR Receiver Modules  
 Optocouplers and Solid-State Relays  
 Optical Sensors  
 LEDs and 7-Segment Displays  
 Infrared Data Transceiver Modules  
 Custom Products

### ICs

Power ICs  
 Analog Switches  
 RF Transceivers and Receiver Modules  
 ICs for Optoelectronics

### MODULES

Power Modules (contain power diodes,  
 thyristors, MOSFETs, IGBTs)  
 DC/DC Converters

## PASSIVE COMPONENTS

### RESISTIVE PRODUCTS

Foil Resistors  
 Film Resistors  
 Metal Film Resistors  
 Thin Film Resistors  
 Thick Film Resistors  
 Metal Oxide Film Resistors  
 Carbon Film Resistors  
 Wirewound Resistors  
 Power Metal Strip® Resistors  
 Chip Fuses  
 Variable Resistors  
 Cermet Variable Resistors  
 Wirewound Variable Resistors  
 Conductive Plastic Variable Resistors  
 Networks/Arrays  
 Non-Linear Resistors  
 NTC Thermistors  
 PTC Thermistors  
 Varistors

### MAGNETICS

Inductors  
 Transformers

### CAPACITORS

Tantalum Capacitors  
 Molded Chip Tantalum Capacitors  
 Coated Chip Tantalum Capacitors  
 Solid Through-Hole Tantalum Capacitors  
 Wet Tantalum Capacitors  
 Ceramic Capacitors  
 Multilayer Chip Capacitors  
 Disc Capacitors  
 Film Capacitors  
 Power Capacitors  
 Heavy-Current Capacitors  
 Aluminum Capacitors  
 Silicon RF Capacitors

### STRAIN GAGE TRANSDUCERS AND STRESS ANALYSIS SYSTEMS

PhotoStress®  
 Strain Gages  
 Load Cells  
 Force Transducers  
 Instruments  
 Weighing Systems  
 Specialized Strain Gage Systems

# **Bulk Metal<sup>®</sup> Foil Resistors Complete Resource Guide**

**Vishay Intertechnology**  
63 Lancaster Ave.  
Malvern, PA 19355  
Phone: + 1 610 644 1300  
Fax: + 1 610 296 0657  
[www.vishay.com](http://www.vishay.com)

**DISCLAIMER** All product specifications and data are subject to change without notice. Vishay Intertechnology, Inc., its affiliates, agents, and employees, and all persons acting on its or their behalf (collectively, "Vishay"), disclaim any and all liability for any errors, inaccuracies or incompleteness contained herein or in any other disclosure relating to any product. Vishay disclaims any and all liability arising out of the use or application of any product described herein or of any information provided herein to the maximum extent permitted by law. The product specifications do not expand or otherwise modify Vishay's terms and conditions of purchase, including but not limited to the warranty expressed therein, which apply to these products. No license, express or implied, by estoppel or otherwise, to any intellectual property rights is granted by this document or by any conduct of Vishay. The products shown herein are not designed for use in medical, life-saving, or life-sustaining applications unless otherwise expressly indicated. Customers using or selling Vishay products not expressly indicated for use in such applications do so entirely at their own risk and agree to fully indemnify Vishay for any damages arising or resulting from such use or sale. Please contact authorized Vishay personnel to obtain written terms and conditions regarding products designed for such applications. Product names and markings noted herein may be trademarks of their respective owners.





<b>Introduction</b> .....	5
<b>Technology Product Life Cycle</b> .....	6
<b>Seven Reasons to Specify Bulk Metal® Foil Resistors</b> .....	7
<b>Selector Guides</b> .....	15
a. Surface-Mount .....	15
b. Through-Hole .....	19
c. Power Current-Sensing .....	25
d. Hermetically-Sealed .....	30
e. Voltage Dividers and Resistor Networks .....	33
f. Trimming Potentiometers .....	38
g. Hybrid Chips and Custom Designed Hermetically-Sealed Networks .....	40
h. Military and Aerospace .....	43
<b>Technical Notes</b> .....	48
a. Resistor Sensitivity to Electrostatic Discharge (ESD) .....	48
b. The Effects of Short-Time Overload on Resistive Elements .....	51
c. Designing with Foil Resistors in Hermetic Packages .....	54
d. Resistance Trimmers .....	60
e. Ultra-High Precision Bulk Metal® Foil Resistors in Extreme Environments .....	63
<b>Application Notes</b> .....	65
a. Power coefficient of Resistance (PCR).....	65
b. Advanced Medical Applications, Treatment Solutions, and Biotechnology .....	67
c. Audio Noise Reduction Through the Use of Bulk Metal Foil Resistors — “Hear the Difference” .....	73
<b>Demonstrations</b> .....	76
<b>Prototype Service</b> .....	80
<b>Contacts</b> .....	83

Bulk Metal® Foil technology, first introduced by Vishay in 1962, still out-performs all other resistor technologies available for applications that require precision, stability, and reliability. Vishay's unique, ultra-precision Bulk Metal Foil resistor products provide extremely low temperature coefficient of resistance (TCR) and exceptional long-term stability through temperature extremes. Vishay has grown from being a leader in one area — Bulk Metal Foil resistive products — to being a leader in passive components and discrete semiconductors. Nevertheless, Vishay continues to develop, manufacture, and market new types of foil resistor products, including military-established-reliability components (EEE-INST-002, DSCC, CECC, ESA, ER, QPL, etc).

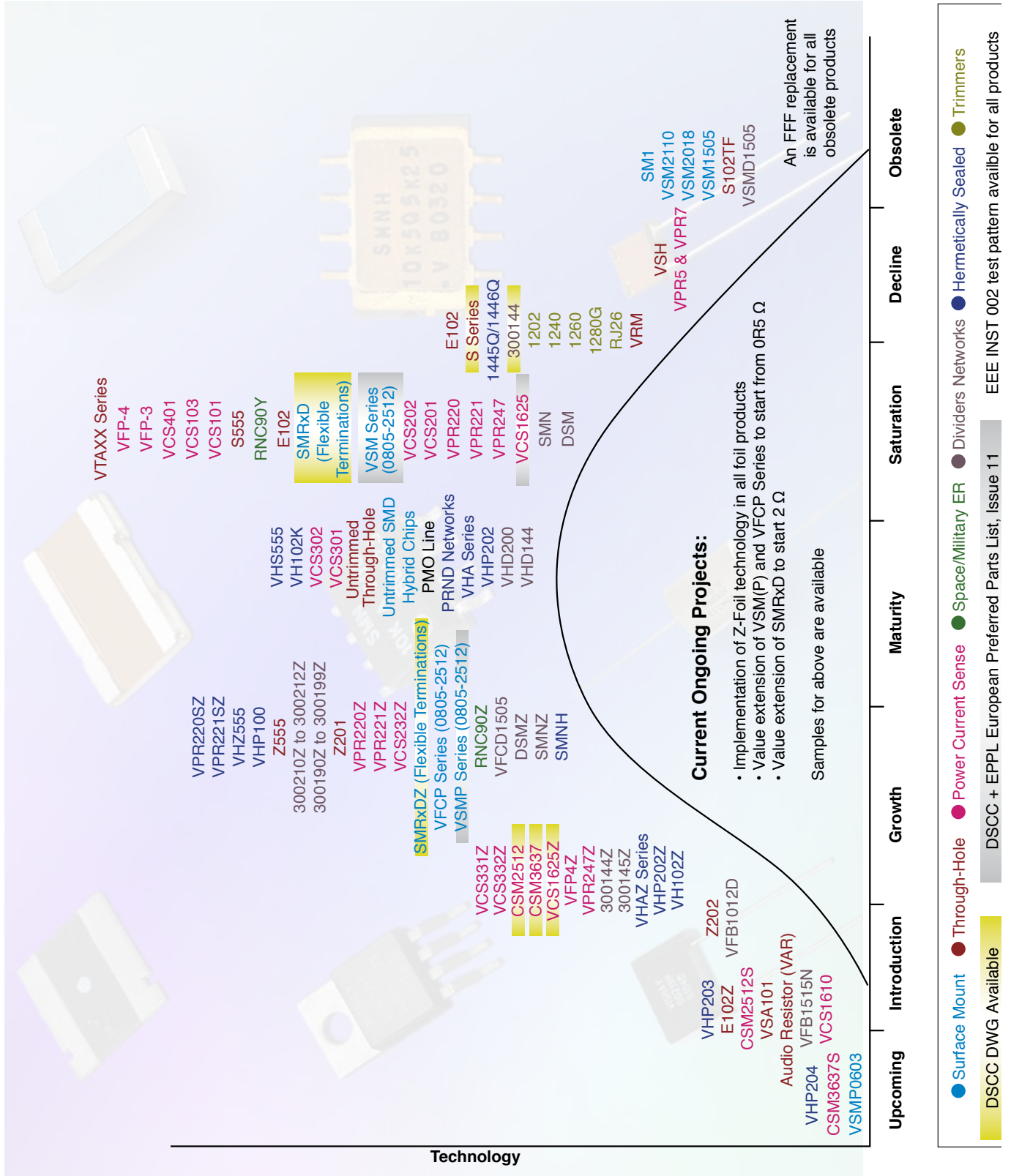
The Vishay Foil Resistors portfolio comprises discrete resistors and resistor networks in surface mount and through-hole (lead) configurations, precision trimming potentiometers, and discrete chips for use in hybrid circuits. Customized chip resistor networks and resistor arrays can also be manufactured. In this Complete Resource Guide, Vishay has brought together all the technical data you need to choose the best Bulk Metal Foil resistor for your application — including selector guides, technical notes, and application notes.

The selector guides are divided into sections providing the resistance range, tolerance, TCR, rated power, power coefficient of resistance (PCR), and load life stability of Bulk Metal Foil products in seven categories:

- Surface-Mount
- Through-Hole
- Voltage Dividers and Resistor Networks
- Power Current-Sensing
- Hermetically-Sealed
- Trimming Potentiometers
- Hybrid Chips and Custom Designed Hermetically-Sealed Networks



# Vishay Bulk Metal® Foil Technology Product Life Cycle



## INTRODUCTION

More than four and a half decades after its invention by physicist Dr. Felix Zandman in 1962, Bulk Metal® Foil (BMF) technology still outperforms all other resistor technologies available today for applications that require precision, stability, and reliability. Vishay offers Bulk Metal® Foil products in a variety of resistor configurations and package types to meet the needs of a wide range of applications.

In 2000, Vishay achieved a technological breakthrough with the introduction of Bulk Metal® Z-Foil. Products built on this revolutionary technology deliver an absolute temperature coefficient of resistance (TCR) of 0.2 ppm/°C. The lower the TCR, the better a resistor can maintain its precise value despite ambient temperature variations and self-heating when power is applied.

By taking advantage of the overall stability and reliability of Vishay Bulk Metal® Foil resistors, designers can significantly reduce circuit errors and greatly improve overall circuit performance. Bulk Metal® technology allows Vishay to produce customer-oriented products designed to satisfy challenging technical requirements. Customers are invited to contact our Application Engineering Department with non-standard technical requirements and special applications (email: foil@vishay.com).

## KEY FEATURES

- Temperature coefficient of resistance (TCR) for Z-Foil technology
  - $\pm 0.05$  ppm/°C typical ( 0 °C to +60 °C )
  - $\pm 0.2$  ppm/°C typical ( -55 °C to +125 °C, +25 ref. )
- Power coefficient of resistance for Z-Foil technology
  - “ $\Delta R$  due to self heating”:  $\pm 5$  ppm at rated power
- Load life stability: to  $\pm 0.005\%$  at +70 °C, 2,000 hours at rated power
- Resistance tolerance: to  $\pm 0.001\%$  ( 10 ppm )
- Resistance range: 2m $\Omega$  to 3.3M $\Omega$
- Electrostatic discharge (ESD) above 25, 000 V
- Non inductive, non capacitive design
- Rise time: 1 ns without ringing
- Fast thermal stabilization
- Current Noise  $\leq -40$  dB
- Thermal EMF: 0.05  $\mu$ V/°C
- Voltage Coefficient:  $< 0.1$  ppm/V
- Lead (Pb) free and Tin/Lead terminations are available

## RANGE OF FOIL RESISTOR PRODUCTS

- Surface mount chips, molded resistors and networks
- Power resistors and current sensors
- Military established reliability ( QPL, DSCC, EEE-INST-002, ESA, CECC)
- Leaded (Through-Hole)
- Hermetically-sealed and molded discrete resistors and networks
- Trimming potentiometers
- Voltage dividers
- Hybrid chips (wire-bondable chips)

## REASON 1

### LOW TEMPERATURE COEFFICIENT OF RESISTANCE (TCR)

“Why are extremely low TCR resistors required?” is a proper question when evaluating the performance and cost of a system. The answers are as numerous as the systems in which they are installed. The following pages discuss 7 different individual technical characteristics of the bulk metal foil technology that are important to precision circuits. While each characteristic is discussed independently for clarity, many circuits require some specific combination of these characteristics and, often, all characteristics are required in the same resistive devices. For example, one might examine the requirements of an operational amplifier.

In operational amplifiers the gain is set by the ratio of the feedback resistor to the input resistor. With differential amplifiers the Common Mode Rejection Ratio is based on the ratios of a four-resistor set. In both cases, any change in the ratios of these resistors directly affects the function of the circuit. The ratios might change due to different absolute temperature coefficients experiencing differential heating ( either internal or external), differential tracking through changes in ambient temperature, differential time-response to step inputs or high frequency signals, differential Joule heating due to different power levels, different changes in resistance over design life, etc. So it can easily be seen that it is common for many circuits to depend on many application-related stability characteristics---all at the same time in the same devices. The foil technology is the ONLY resistor technology that provides the tightest envelope of ALL of these characteristics in the same resistor devices, with low noise also coming along as inherent to the foil technology. Whether necessary for any specific application or not, all of these characteristics are inherent to the foil technology and are all automatically included in any of the foil resistors.

The solution to these problems is extremely low **absolute** TCR resistors to keep temperature-induced changes to a minimum.

## FOIL TCR

Two predictable and opposing physical phenomena within the composite structure of the resistive alloy and its substrate are the key to the low TCR capability of Bulk Metal® Foil:

- Resistivity of the resistive alloy changes directly with temperature. (Resistance of the foil increases when temperature increases.)
- The difference between the coefficient of thermal expansion of the alloy and substrate are different resulting in a compressive stress on the resistive alloy when temperature increases. (Resistance of the foil decreases due to compression caused by the temperature increases.)

The TCR of the Vishay Bulk Metal Foil resistor is achieved by matching two opposing effects - the inherent increase in resistance due to temperature increase vs. the compression - related decrease in resistance due to that same temperature increase. The two effects occur simultaneously resulting in an unusually low predictable, repeatable,

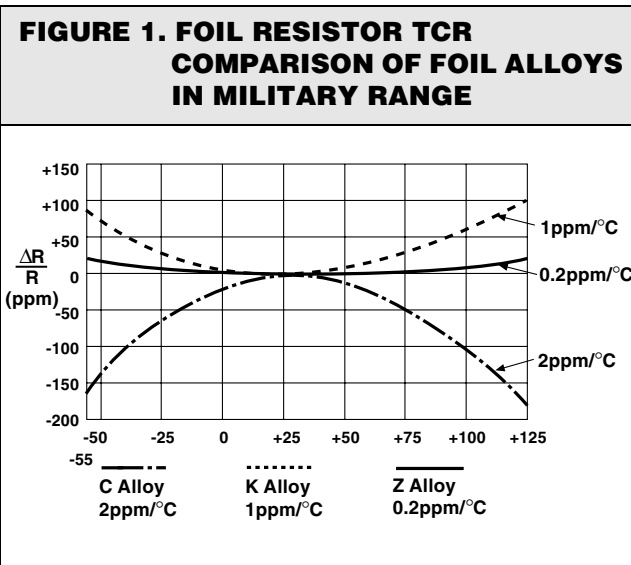


and controllable TCR. Due to Vishay's Bulk Metal® Foil resistor design, this TCR characteristic is accomplished automatically, without selection, and regardless of the resistance value or the date of manufacture — even if years apart!

## IMPROVED TCR IN BULK METAL® Z-FOIL RESISTORS TO ±0.2 PPM/°C

Foil resistor technology has continued to progress over the years, with significant improvements in TCR. Figure 1 shows the typical TCR characteristics of the various foil alloys utilized by Vishay to produce Bulk Metal® Foil resistors.

The original Alloy C Foil exhibits a negative parabolic response to temperature with a positive chord slope on the cold side and a



negative chord slope on the hot side.

Following was the Alloy K Foil which produced an opposite parabolic response with temperature with a negative chord slope on the cold side and a positive chord slope on the hot side. In addition, it provides a TCR approximately one half that of Alloy C Foil.

The latest development is the Alloy Z Foil Technology Breakthrough which has a similar parabolic response as the Alloy K Foil but produces TCR characteristics an order of magnitude better than Alloy C and five times better than Alloy K.

Using this technology, extremely low TCR resistors have been developed that provide virtually zero response to temperature. See the data sheet for the Vishay Thermotropic VHP100, ultra performance Z201, hermetically sealed VH102Z resistors and Foil Surface-Mount Chip resistors: VSMP series, VFPC series and VCS1625Z.

These technological developments have resulted in a major improvement in TCR characteristics compared to what was available from Vishay before, and what is available in any other resistor technology. Use Bulk Metal® Foil resistors for all extremely low TCR requirements.

## TYPICAL TCR

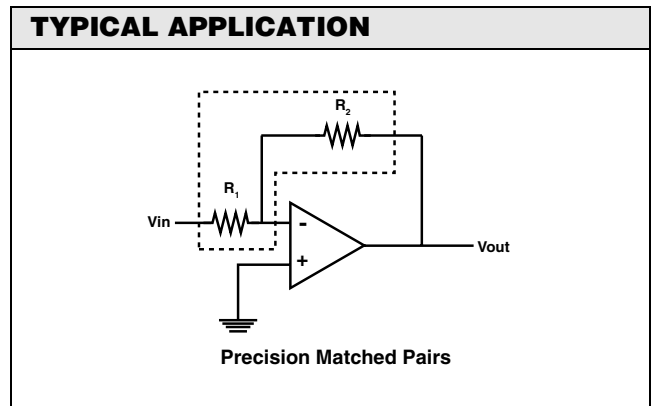
Vishay Typical TCR is defined as the chord slopes of the relative change of resistance vs temperature (RT) curve, and is expressed in ppm/°C (parts per million per degree centigrade). Slopes are defined from 0 °C to + 25 °C and + 25 °C to + 60 °C (Instrument Range); and from - 55 °C to + 25 °C and + 25 °C to + 125 °C (Military Range). These specified temperatures and the defined typical TCR chord slopes apply to all resistance values including low value resistors. Note, however, that without four terminals and Kelvin connections in low values, allowance for lead resistance and associated TCR may have to be made. All resistance and TCR measurements of leaded styles are made by the factory at a gage point 1/2" from the standoffs. Contact Applications Engineering Department for the TCR increase to be expected for low value resistors.

## UNDERSTANDING RESISTOR FIGURES OF MERIT

### TCR TRACKING

"Tracking" is the stability of the ratio(s) of two or more resistors. When more than one resistor shares the same substrate, the TCR tracking will be much better than the TCR provided by two discrete resistors. Resistors with different technologies increase or decrease in value when temperatures change. Resistance ratio tracking is influenced by heat that comes from outside the device (such as a rising ambient temperature or adjacent hotter objects) and from inside the device (as a result of self-heating due to power dissipation). Resistors may be selected for good TCR tracking when they are all at the same temperature. But, changes due to differential internal temperatures (e.g. differential power dissipation) or different local temperatures (e.g. differential heating from neighboring components) are superimposed upon the tracking and cause additional temperature - related errors. **Therefore, low absolute TCR is as important as tracking in precision applications.**

The best analog design would be using a fundamentally low absolute TCR resistor since it would minimize the effect of ambient temperature and self-heating.



This is impossible to accomplish with high TCR resistors even with good initial TCR Tracking.

## POWER COEFFICIENT (PCR)

The TCR of a resistor for a given temperature range is established by measuring the resistance at two different ambient temperatures: at room temperature and in a cooling chamber or oven. The ratio of relative resistance change and temperature difference gives the slope of  $\Delta R/R = f(T)$  curve. This slope is usually expressed in parts per million per degree Centigrade (ppm/°C).

In these conditions, a uniform temperature is achieved in the measured resistance. In practice, however, the temperature rise of the resistor is also partially due to self-heating as a result of the power it is dissipating. Therefore, the TCR alone does not provide the actual resistance change. Hence, another figure of merit, PCR (power coefficient), was introduced. PCR is expressed in parts per million per Watt or in ppm at rated power. In the case of Z-based Bulk Metal® Foil, the PCR is 5 ppm typical at rated power or 4 ppm per watt typical for power resistors.

## REASON 2 TIGHT RESISTANCE TOLERANCE

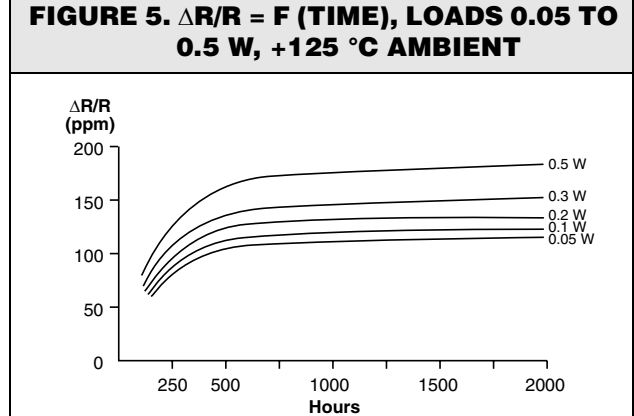
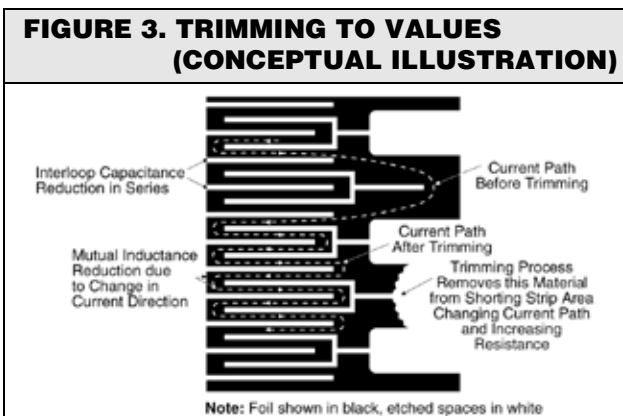
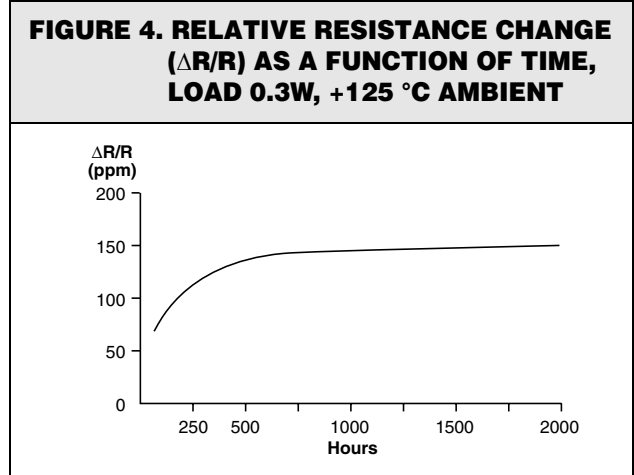
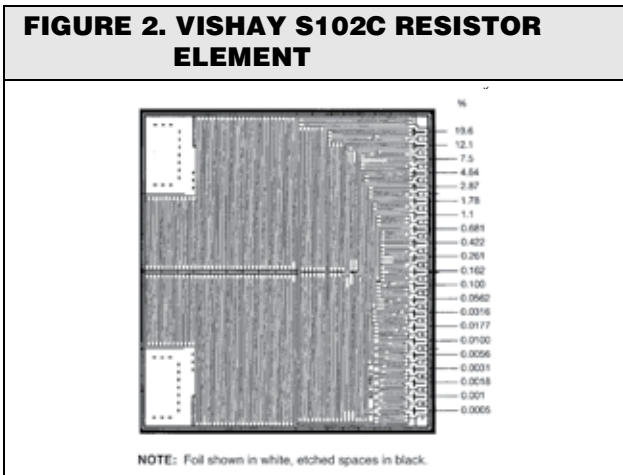
Why do users employ tight tolerance resistors? A system or a device or one particular circuit element must perform for a specified period of time and at the end of that service period, it must still perform

within specification. During its service life, it may have been subjected to some hostile working conditions and therefore may no longer be within purchased tolerance. One reason for specifying a tighter purchased tolerance than the end of life error budget tolerance is to allow room for service shifts. Another reason is that the error budget is more economically applied to resistors than to most other components.

The Bulk Metal Foil resistors are calibrated as accurately as 0.001% by selectively trimming various adjusting points that have been designed into the photoetched pattern of the resistive element (See Figure 2). They provide predictable step increases in resistance to the desired tolerance level. Trimming the pattern at one of these adjusting points will force the current to seek another longer path, thus raising the resistance value of the element by a specific percentage. In the fine adjust areas, trimming affects the final resistance value by smaller and smaller amounts down to 0.001% and finally 0.0005% (5 ppm). This is the trimming resolution (See Figure 3).

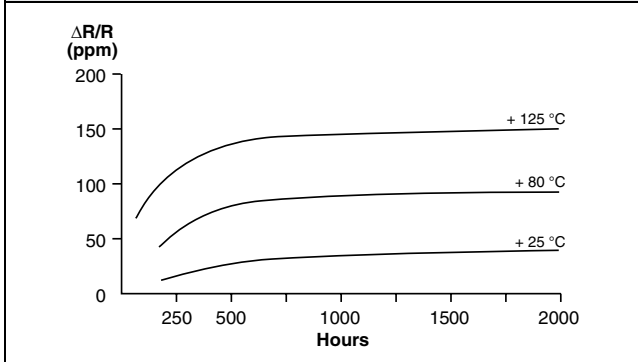
## REASON 3 EXCELLENT LOAD-LIFE STABILITY

Why are designers concerned about stability with applied load? Load-life stability is the characteristic most relied upon to demonstrate a resistor's long-term reliability. Military testing requirements to 10,000 hours with limits on amount of shift and the number of failures

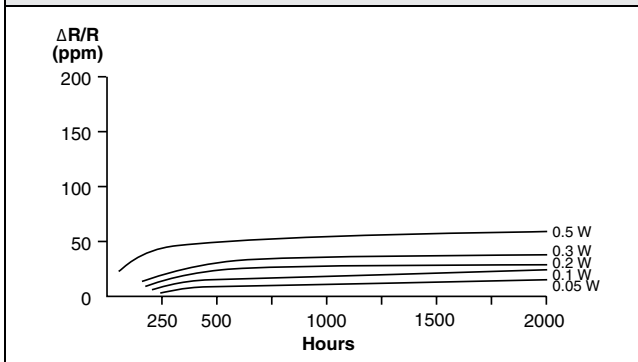




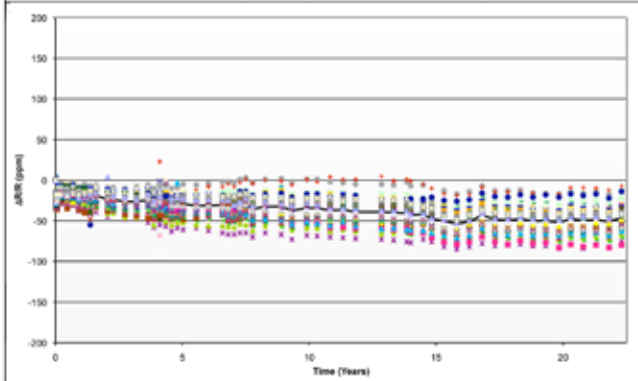
**FIGURE 6.  $\Delta R/R = F$  (TIME), LOADS 0.3 W, DIFFERENT AMBIENT TEMPERATURES**



**FIGURE 7.  $\Delta R/R = F$  (TIME), LOADS 0.05 TO 0.5 W, +25 °C AMBIENT**



**FIGURE 8. LONG TERM STABILITY OVER 22 YEARS (0.1W AT 70 °C) 50 Samples (S102C, 10K $\Omega$ )**



results in a failure rate demonstration. Precision Bulk Metal® Foil resistors have the tightest allowable limits. Whether military or not, the load-life stability of foil resistors is unparalleled and long-term serviceability is assured.

The reason foil resistors are so stable has to do with the materials of construction (Bulk Metal® Foil and high alumina substrate). For example, the S102C resistor is rated at 0.3 W at 125 °C with an allow-

able  $\Delta R$  of 150 ppm after 2000 hours under load. (See Figures 4 and 5 for the demonstrated behavior). Conversely, the  $\Delta R$  is reduced by decreasing the applied power which lowers the element temperature rise in Vishay resistors. Figure 4 shows the drift due to load-life testing at rated power and Figure 5 shows the drift due to load-life testing at reduced power. Reducing the ambient temperature has a marked effect on load-life results and Figure 6 shows the drift due to rated power at different ambient temperatures. The combination of lower power and ambient temperature is shown in Figure 7. for model S102C.

For evaluation of load-life stability, the two parameters which must be mentioned together, power rating and ambient temperature, can be joined into one single parameter for a given style of resistor. If the steady state temperature rise can be established, it can be added to the ambient temperature, and the sum will represent the combined (load induced + ambient) temperature. For instance, the Vishay S102C resistor has a temperature rise of 9 °C per 0.1 W of applied power. This leads to the following example calculations:

If  $T = 75$  °C,  $P = 0.2$  W, and  $t = 2000$  hrs. ;  
Then self-heating =  $9$  °C  $\times$   $2 = 18$  °C.

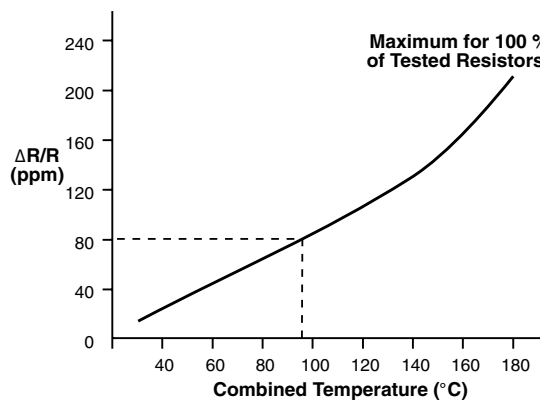
$18$  °C rise +  $75$  °C ambient =  $93$  °C total  $\Delta R$ .

$R$  max = 80 ppm from the curve of Figure 9.

Figure 9 shows, for a given duration of load life test, how the drift increases with the level of the applied combined temperature. As explained above, the combined temperature comprises the effect of power induced temperature rise and the ambient temperature. The curve shows maximum drift.

**FIGURE 9. MAXIMUM RESISTANCE SHIFTS AFTER 2 000 HRS. OF LOAD LIFE TEST UNDER THERMAL STRESSES\***

\* Combined temperature— ambient and temperature rise due to applied power.



This information is based on product taken off the line without any screen testing or power conditioning. Further drift reduction is available by factory power conditioning. Consult Applications Engineering for this and other screening tests that are available.

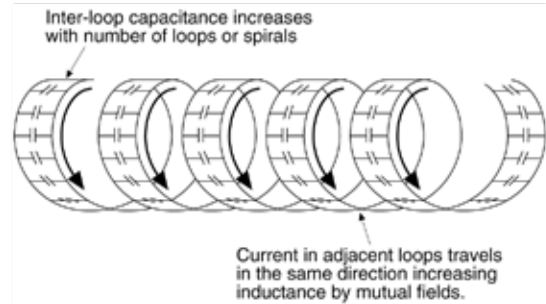
## REASON 4 HIGH SPEED AND RESPONSE TIME

The equivalent circuit of a resistor, as shown in Figure 10, combines a resistor in series with an inductance and in parallel with a capacitance. Resistors can perform like an R/C circuit, filter or inductor depending on their geometry. In spiraled and wirewound resistors, these reactances are created by the loops and spaces formed by the spirals or turns of wire. Figure 11 shows how the capacitance and inductance increase as the resistance value increases due to continually increasing the number of spirals or turns. In planar resistors such as the Vishay Bulk Metal® Foil resistors, the geometry of the lines of the resistor patterns are intentionally designed to counteract these reactances. Figure 12 shows a typical serpentine pattern of a planar resistor. Opposing current directions in adjacent lines reduces mutual inductance while geometry - related inter-line capacitance reduces overall capacitance.

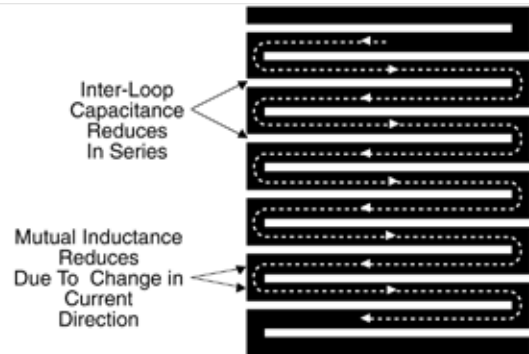
Reactance distorts input signals, particularly in pulse applications. Figure 13 shows the current response to a voltage pulse comparing a fast Bulk Metal® Foil resistor to a slower wirewound. Here a pulse width of one nanosecond would have been completely missed by the wirewound resistor while the foil resistor achieves full replication in the time allotted.

In frequency applications, these reactive distortions also cause changes in apparent resistance (impedance) with changes in frequency. Figure 14 shows a family of curves relating the AC resistance to the DC resistance in Bulk Metal® Foil resistors. Very good response is seen in the 100 Ω range out to 100 MHz and all values have good response out to 1 MHz. The performance curves for other types of resistors can be expected to show considerably more distortion (particularly wirewounds).

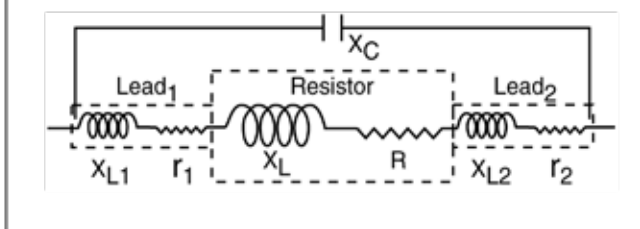
**FIGURE 11. CAPACITANCE AND INDUCTANCE IN A WOUND OR SPIRALED RESISTOR**



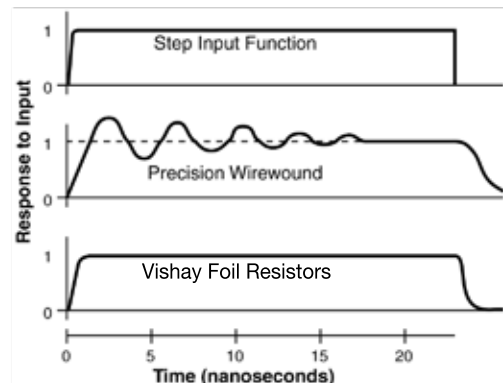
**FIGURE 12. BULK METAL® FOIL PLANAR DESIGN**



**FIGURE 10. THE EQUIVALENT CIRCUIT OF A RESISTOR**

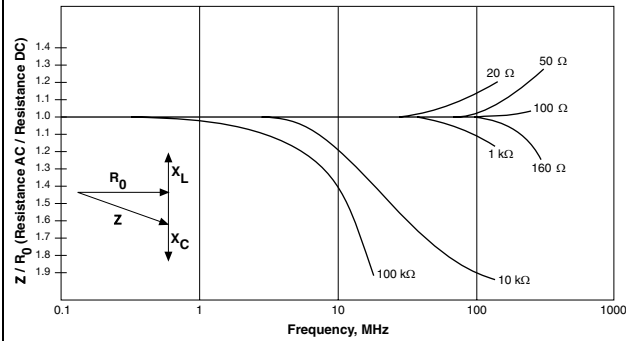


**FIGURE 13. COMPARISON OF A RESPONSE TO A PULSE**





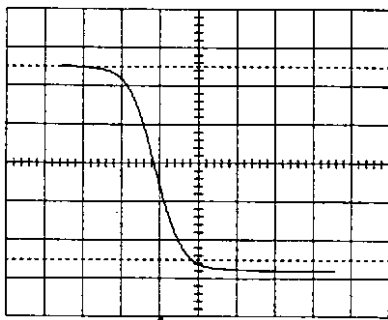
**FIGURE 14. EFFECT OF OPERATION AT FREQUENCY**



## REASON 5 LOW NOISE; “HEAR THE DIFFERENCE”

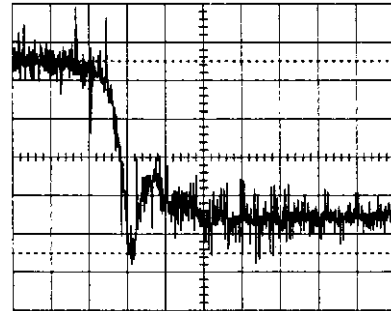
As sound reproduction requirements become more demanding, the selection of circuit components become more exacting and the resistors in the signal path are critical. Measurement instrumentation based on low level signal inputs and high gain amplification cannot tolerate microvolt level background noise when the signal being measured is itself in the microvolt range. Although audio circuitry, where signal purity is of utmost concern, is the most obvious use of noise-free components, other industries and technologies are equally concerned with this characteristic.

**FIGURE 15. SEGMENT OF A FUNDAMENTAL CURVE**

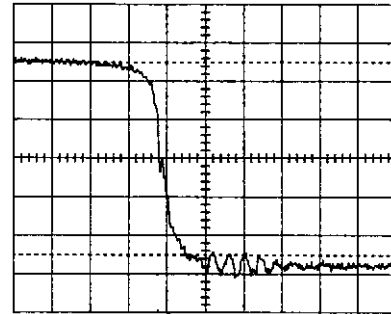


Resistors, depending on construction, can be a source of noise. This unintended signal addition is measurable and independent of the presence of a fundamental signal.

**FIGURE 16. SIGNAL WITH ADDED RESISTOR NOISE**

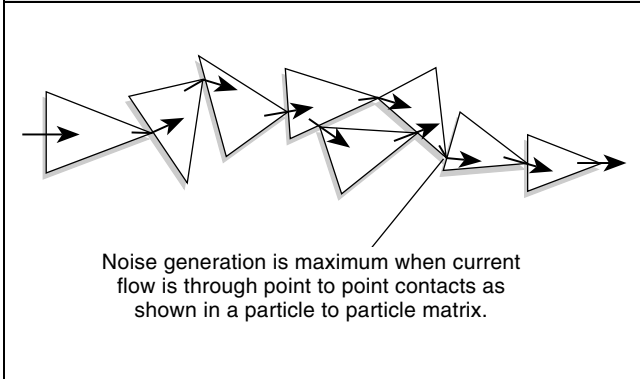


**FIGURE 17. SIGNAL WITH A “NOISE-FREE” RESISTOR**



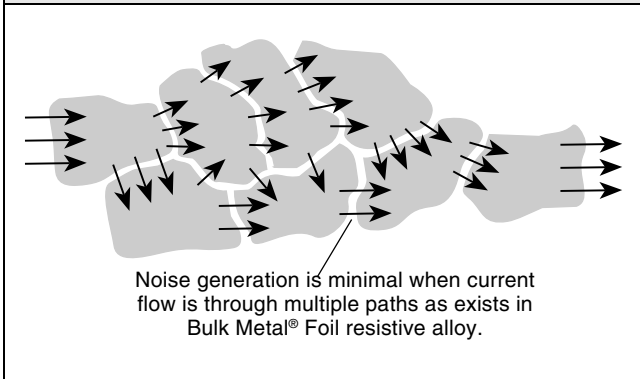
Figures 16 and 17 illustrate the effects of resistor noise on a fundamental signal. Resistors made of conductive particles in a non-conductive binder are the most likely to generate noise. In carbon composition and thick film resistors, conduction takes place at points of contact between the conductive particles within the binder matrix. Where these point-to-point contacts are made constitutes a high resistance conduction site which is the source for noise. These sites are sensitive to any distortion resulting from expansion mismatch, moisture swelling, mechanical strain, and voltage input levels. The response to these outside influences is an unwanted signal as the current finds its way through the matrix. Figure 18 illustrates this current path.

**FIGURE 18. THE CURRENT PATH IN A PARTICLE-TO-PARTICLE MATRIX**



Resistors made of metal alloys, such as the Vishay Bulk Metal® Foil resistor, are the least likely to be noise sources. Here the conduction is across the inter-granular boundaries of the alloy. The intergranular current path from one or more metal crystals to another involves multiple and long current paths through the boundaries reducing the chance for noise generation. Figure 19 illustrates this current path.

**FIGURE 19. THE CURRENT PATH IN A RESISTIVE ALLOY**



In addition, the photolithography and fabrication techniques employed in the manufacture of Bulk Metal® Foil resistors results in more uniform current paths than found in some other resistor constructions. Spiraled resistors, for example, have more geometric variations that contribute to insertion of noise signals. Bulk Metal® Foil resistors have the lowest noise of any resistor technology, with the noise level being essentially immeasurable. Signal purity can be a function of the selection of resistor technology for pre-amp and amplifier applications. Vishay Foil Resistors offer the best performance for low noise audio applications.

## REASON 6 LOW THERMAL EMF

When a junction is formed by two dissimilar metals, and is heated, a voltage is generated due to the different levels of molecular activity within these metals. This electromotive force, induced by temperature, is called Thermal EMF and is usually measured in microvolts. A useful purpose of this Thermal EMF is the measurement of temperature using a thermocouple and microvolt meter.

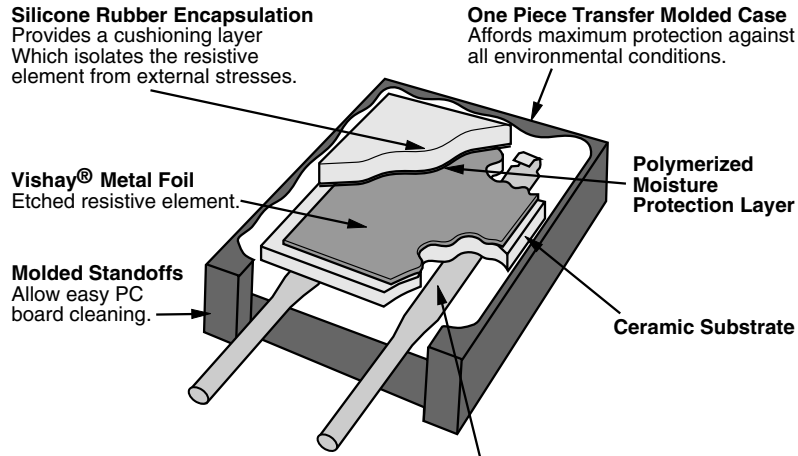
In resistors, this Thermal EMF is considered a parasitic effect interfering with pure resistance. It is often caused by the dissimilarity of the materials used in the resistor construction especially at the junction of the resistor element and the lead materials. The Thermal EMF performance of a resistor can be degraded by external temperature difference between the two junctions, dissymmetry of power distribution within the element, and the dissimilarity of the molecular activity of the metals involved.

A key feature of the Vishay Bulk Metal® Foil resistor is its low Thermal EMF design. The flattened paddle leads make intimate contact with the chip thereby maximizing heat transfer and minimizing temperature variations. The resistor element is designed to uniformly dissipate power without creating hot spots and the lead material is compatible with the element material. These design factors result in a very low Thermal EMF resistor.

**FIGURE 20. RUGGEDIZED CONSTRUCTION**

The combination of ruggedized leads and molded case, plus the highly efficient heat transfer characteristics of the unique assembly and the ceramic substrate results in a high reliability resistor with excellent moisture resistance, high temperature, and load-life capabilities. These also afford a very low Thermal EMF.

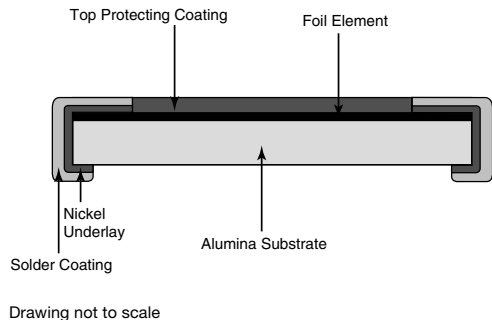
Flattened “paddles” are wrapped around the resistance element structure and welded directly to the resistance alloy - thus there is only one weld per lead. The closely related thermal characteristics of the selected materials, combined with the unique “paddle” lead design, produce a resistor with extremely low Thermal EMF.



**Paddle Leads with Welded Terminations— No Ribbons**  
 Only two welds, both remote from the lead-to-case point-of-entry, the best arrangement for maximum reliability. Excellent moisture resistance, high temperature, and load-life capabilities, low Thermal EMF.

**FIGURE 21. SURFACE-MOUNT WRAP-AROUND CHIP FOIL RESISTOR CONSTRUCTION**

Thermal design of surface-mount chip foil resistor produces a resistor with extremely low thermal EMF.



## REASON 7 NON-MEASURABLE VOLTAGE COEFFICIENT

As mentioned earlier in our section on resistor noise, resistors can change value due to applied voltage. The term used to describe the rate of change of resistance with changing voltage is known as voltage coefficient. Resistors of different constructions have noticeably different voltage coefficients. In the extreme case, the effect in a carbon

composition resistor is so noticeable that the resistance value varies greatly as a function of the applied voltage. Vishay Bulk Metal® Foil resistor elements are insensitive to voltage variation and the designer can count on foil resistors having the same resistance under varying circuit voltage level conditions. The inherent bulk property of the metal alloy provides a non-measurable voltage coefficient.

## CONCLUSION ALL IN ONE RESISTOR

The seven reasons to specify Vishay Bulk Metal® Foil resistors are inherent in the design and are not a function of manufacturing variables or a selection process. This combination of parameters is not available in any other resistor technology. Vishay Bulk Metal® Foil resistors provide a unique, inherent combination of performance characteristics resulting in unmatched performance and high reliability satisfying the needs of today's expanding requirements.

## SPECIAL ORDER

Consider Vishay Bulk Metal® Foil Resistors for all of your low TCR needs. Special orders may be placed for low TCR, low value resistors, and tight TCR tracking of individual resistors and network combinations. Contact the Applications Engineering Department to discuss your requirements for these and any other TCR applications. (email: foil@vishay.com).

## Surface-Mount Resistors

### KEY BENEFITS

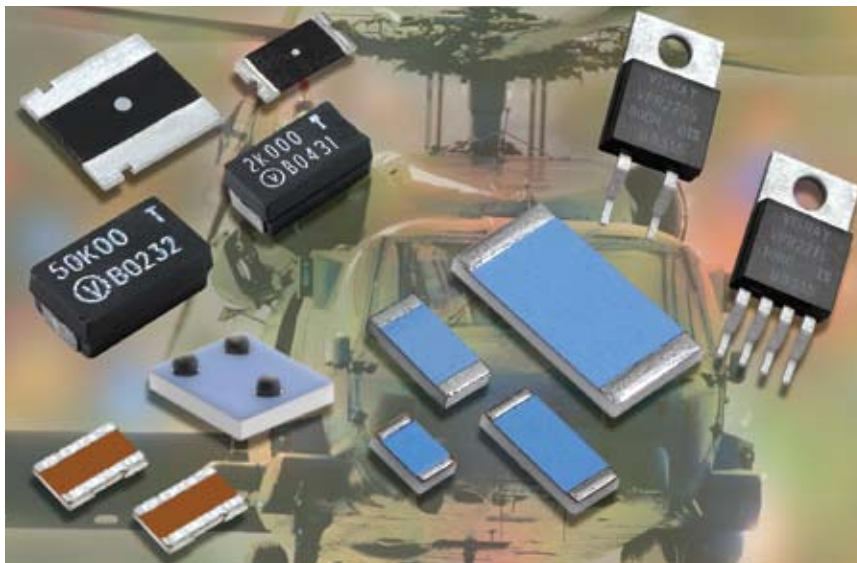
- Temperature coefficient of resistance (TCR):
  - $\pm 0.05$  ppm/ $^{\circ}\text{C}$  (0  $^{\circ}\text{C}$  to 60  $^{\circ}\text{C}$ ) typical with Z-Foil
  - $\pm 0.2$  ppm/ $^{\circ}\text{C}$  (-55  $^{\circ}\text{C}$  to +125  $^{\circ}\text{C}$ , +25  $^{\circ}\text{C}$  ref.) typical with Z-Foil
- Tolerance to  $\pm 0.01$  %
- Power Coefficient of Resistance (PCR) " $\Delta R$  due to self heating": 5 ppm at rated power with Z-Foil
- Electrostatic discharge (ESD) above 25 kV
- Overload Capability (6.25 X rated power, 5 seconds) < 0.005% (50 ppm)
- Rise Time: 1 ns without ringing
- Structure and process provides low sensitivity to moisture
- Non-inductive, non-capacitive design
- Current Noise: -40 dB
- Matched sets are available upon request
- Any value at any tolerance within resistance range (e.g. 123.43  $\Omega$ )
- Lead (Pb) free and Tin/Lead terminations available
- Prototype samples available from 72 hours

### APPLICATIONS

- Military and aerospace: DSCC Drawings and EEE-INST-002 available
- Commercial aviation
- Aircraft and missile guidance systems
- Medical
- Automatic test equipment (ATE)
- Electron beam applications
- Measurement systems
- Current sensing
- High-precision amplifiers
- Weighing systems

**Our goal is to find solutions for challenging applications.**

**For any questions, please contact [Foil@vishay.com](mailto:Foil@vishay.com)**



Model	Global Model	Product Description	Resistance Range*	Best Tolerance	TCR (-55 °C to +125 °C, +25 °C ref.) Typical	Rated Power at 70 °C	PCR – Power Coefficient	Load-life Stability 2000 Hours, +70 °C Under Power
<b>SMR1DZ (Z-Foil)</b> 6.0 mm x 3.2 mm 	Y1745	Ultra-high-precision molded resistor with <b>flexible</b> terminations DSCC 06020	5 Ω to 33 KΩ	±0.01 %	±0.2 ppm/°C	0.25 W	5 ppm @ rated power	±0.005 %
<b>SMR1D</b> 6.0 mm x 3.2 mm 	Y1121	High-precision molded resistor with <b>flexible</b> terminations DSCC 06020	5 Ω to 33 KΩ	±0.01 %	±2 ppm/°C	0.25 W		
<b>SMR3DZ (Z-Foil)</b> 7.3 mm x 4.3 mm 	Y1746	Ultra-high-precision molded resistor with <b>flexible</b> terminations DSCC 06021	5 Ω to 80 KΩ	±0.01 %	±0.2 ppm/°C	0.6 W	5 ppm @ rated power	
<b>SMR3D</b> 7.3 mm x 4.3 mm 	Y1169	High-precision molded resistor with <b>flexible</b> terminations DSCC 06021	5 Ω to 80 KΩ	±0.01 %	±2 ppm/°C	0.6 W		
<b>VSMP 0603 (Z-Foil)</b> 	Y1636	Ultra-high-precision wrap-around chip resistor	100 ohm to 4 KΩ	±0.01 %	±0.2 ppm/°C	0.05W	5 ppm @ rated power	
<b>VSMP0805 (Z-Foil)</b> 	Y1624	Ultra-high-precision wrap-around chip resistor DSCC 07024	10 Ω to 12 KΩ**	±0.01 %	±0.2 ppm/°C	0.2 W	5 ppm @ rated power	
<b>VSM0805</b> 	Y1172	High-precision wrap-around chip resistor DSCC 07024	10 Ω to 12 KΩ**	±0.01 %	±2 ppm/°C	0.1 W		
<b>VSMP1206 (Z-Foil)</b> 	Y1625	Ultra-high-precision wrap-around chip resistor DSCC 07025	10 Ω to 30 KΩ**	±0.01 %	±0.2 ppm/°C	0.3 W	5 ppm @ rated power	


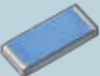
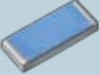
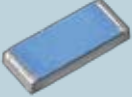
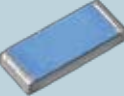
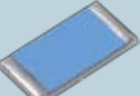
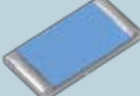
\* Tighter performances and higher or lower value resistances are available for all models upon request.

\*\* < 10 Ω is available

# Selector Guide






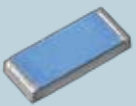
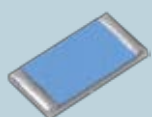


## Surface-Mount Resistors

Model	Global Model	Product Description	Resistance Range *	Best Tolerance	TCR (- 55 °C to +125 °C, +25 °C ref.) Typical	Rated Power at 70 °C	PCR – Power Coefficient	Load-life Stability 2000 Hours, +70 °C Under Power
 <b>VSM1206</b>	Y1496	High-precision wrap-around chip resistor DSCC 07025	10 Ω to 30 KΩ**	±0.01 %	±2 ppm/°C	0.15 W		±0.005 %
 <b>VSMP1506 (Z-Foil)</b>	Y1626	Ultra-high-precision wrap-around chip resistor DSCC 03010	10 Ω to 40 KΩ**	±0.01 %	±0.2 ppm/°C	0.3 W	5 ppm @ rated power	
 <b>VSM1506</b>	Y1455	High-precision wrap-around chip resistor DSCC 03010	10 Ω to 40 KΩ**	±0.01 %	±2 ppm/°C	0.2 W		
 <b>VSMP2010 (Z-Foil)</b>	Y1627	Ultra-high-precision wrap-around chip resistor DSCC 06001	10 Ω to 100 KΩ**	±0.01 %	±0.2 ppm/°C	0.5 W	5 ppm @ rated power	
 <b>VSM2010</b>	Y1611	High-precision wrap-around chip resistor DSCC 06001	10 Ω to 100 KΩ**	±0.01 %	±2 ppm/°C	0.3 W		
 <b>VSMP2512 (Z-Foil)</b>	Y1628	Ultra-high-precision wrap-around chip resistor DSCC 06002	10 Ω to 150 KΩ**	±0.01 %	±0.2 ppm/°C	0.75 W	5 ppm @ rated power	
 <b>VSM2512</b>	Y1612	High-precision wrap-around chip resistor DSCC 06002	10 Ω to 150 KΩ**	±0.01 %	±2 ppm/°C	0.4 W		

Uncalibrated chips are available for VSM and VSMP product families.

\* Tighter performances and higher or lower value resistances are available for all models upon request.

\*\* < 10 Ω is available

Model	Global Model	Product Description	Resistance Range*	Best Tolerance	TCR (- 55 °C to +125 °C, +25 °C ref.) Typical	Rated Power at 70 °C	PCR – Power Coefficient	Load-life Stability 2000 Hours, +70 °C Under Power
<b>VFCP0805 (Z-Foil)</b> 	Y1629	Ultra-high-precision flip-chip resistor	10 Ω to 12 KΩ**	±0.01 %	±0.2 ppm/°C	0.1 W	5 ppm @ rated power	±0.005 %
<b>VFCP1206 (Z-Foil)</b> 	Y1630	Ultra-high-precision flip-chip resistor	10 Ω to 30 KΩ**	±0.01 %	±0.2 ppm/°C	0.25 W	5 ppm @ rated power	±0.005 %
<b>VFCP1506 (Z-Foil)</b> 	Y1631	Ultra-high-precision flip-chip resistor	10 Ω to 40 KΩ**	±0.01 %	±0.2 ppm/°C	0.3 W	5 ppm @ rated power	±0.005 %
<b>VFCP2010 (Z-Foil)</b> 	Y1632	Ultra-high-precision flip-chip resistor	10 Ω to 100 KΩ**	±0.01 %	±0.2 ppm/°C	0.4 W	5 ppm @ rated power	±0.005 %
<b>VFCP2512 (Z-Foil)</b> 	Y1633	Ultra-high-precision flip-chip resistor	10 Ω to 150 KΩ**	±0.01 %	±0.2 ppm/°C	0.6 W	5 ppm @ rated power	±0.005 %
<b>CSM2512S (Improved Stability)</b> 	Y4487	Ultra-high-precision current-sense resistor	0R01 to 0R1	±0.1 %	±15 ppm/°C maximum ±10 ppm/°C is available	1 W		±0.05 %
<b>CSM3637S (Improved Stability)</b> 	Y1472	Ultra-high-precision current-sense resistor	0R01 to 0R1	±0.1 %	±15 ppm/°C maximum ±10 ppm/°C is available	2 W		±0.05 %

\* Tighter performances and higher or lower value resistances are available for all models upon request.

\*\* < 10 Ω is available



## Through-Hole Resistors

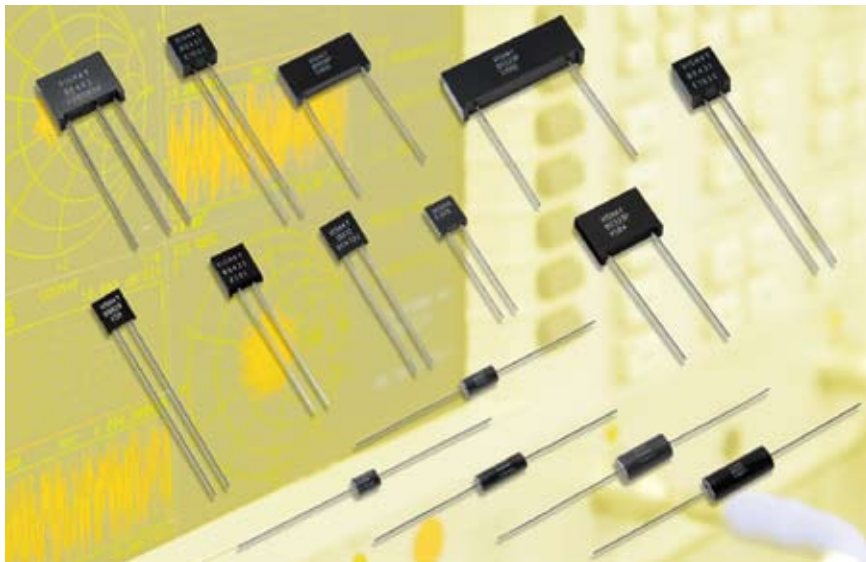
### KEY BENEFITS

- TCR Absolute:
  - $\pm 0.05$  ppm/ $^{\circ}\text{C}$  (0  $^{\circ}\text{C}$  to +60  $^{\circ}\text{C}$ ) typical with Z-Foil
  - $\pm 0.2$  ppm/ $^{\circ}\text{C}$  (-55  $^{\circ}\text{C}$  to +125  $^{\circ}\text{C}$ , +25  $^{\circ}\text{C}$  ref.) typical with Z-foil
- TCR Tracking: to 0.1 ppm/ $^{\circ}\text{C}$
- Power Coefficient of Resistance (PCR) “ $\Delta R$  due to self heating”: 5 ppm at rated power with Z-Foil
- Tolerance: Absolute and Match to  $\pm 0.005$  %
- Electrostatic discharge (ESD) above 25 kV
- Load-life stability: to  $\pm 0.005$  % +125 $^{\circ}\text{C}$ , 2000 hours, at rated power
- Current noise: < -40 dB
- Any value available within resistance range
- Prototype samples available from 72 hours
- Rise Time: 1 ns without ringing



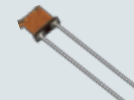






### APPLICATIONS

- Military
- Medical
- Electron Beam applications
- Industrial
- Down-hole
- Commercial and Military avionics
- Audio
- Weigh Scales
- Instrumentation amplifiers
- Laboratory
- Measurement systems
- Aerospace
- Automatic test equipment (ATE)

Requests for technical assistance in the design of precision circuits using Vishay Foil Resistors are welcome; and may reduce the costs for the overall system while improving the performance and reliability of the end product.









Type	Global Model	Product Description	Resistance Range*	Best Tolerance	TCR (-55 °C to +125 °C, +25 °C ref.) Typical	Rated Power	PCR –Power Coefficient	Load-life Stability, 2000 Hours +125 °C at Rated Power
 <b>RNC90Z (RNC90S)</b>	Y1189	Military established reliability QPL	30.1 Ω to 121 KΩ	±0.005 %	±2 ppm/°C (-55 °C to +175 °C) maximum	0.6 W at +70 °C 0.3 W at +125 °C	5 ppm @ rated power	±0.005 %
	Y1506 Y0089 Y1508		4.99 Ω to 121 KΩ					
 <b>RNC90Y (RNC90T)</b>					±5 ppm/°C (-55 °C to +125 °C) maximum ±10 ppm/°C (125 °C to +175 °C) maximum	0.6 W at +70 °C 0.3 W at +125 °C		
 <b>VAR</b>	<b>Y0706</b>	Ultra-high precision, high resolution Z-foil Audio resistor (no molded jacket)	10 Ω to 100 kΩ	±0.01 %	±0.2 ppm/°C	0.4 W at +70 °C 0.2W at +125 °C	5 ppm @ rated power	±0.01 %
 <b>Z555</b>	Y1288	Z-Foil Technology produced in QPL product line	4.99 Ω to 121 KΩ	±0.005 %		0.6 W at +70 °C 0.3 W at +125 °C		±0.005 %
 <b>Z201</b>	Y1453	Ultra-high precision Z-Foil resistor	10 Ω to 100 KΩ	±0.005 %		0.6 W at +70 °C 0.3 W at +125 °C		
 <b>Z202</b>	Y1073	Ultra-High precision miniature resistor	5 Ω to 30 kΩ	±0.01 %		0.25 W at 70 °C 0.125 W at 125 °C		
 <b>VSA101</b>	Y0098	Ultra High Precision Axial Z-Foil Resistor	5 Ω to 100 KΩ	±0.005 %		0.6 W at +70 °C 0.3 W at +125 °C		±0.005 %
 <b>E102Z</b>	Y1183	Ultra High-performance High ohmic value, small size	100 KΩ to 200 KΩ	±0.005 %		0.6 W at +70 °C 0.3 W at +125 °C		±0.005 %
 <b>S555</b>	Y0088	Foil Technology Produced in QPL product line	1 Ω to 150 KΩ	±0.005 %		0.6 W at +70 °C 0.3 W at +125 °C		±0.015 %

Uncalibrated S102 chip on strip resistors are available.

# Selector Guide







## Through-Hole Resistors

Type	Global Model	Product Description	Resistance Range*	Best Tolerance	TCR (-55 °C to +125 °C, +25 °C ref.) Typical	Rated Power	Load-life Stability, 2000 Hours +125 °C at Rated Power
 <b>S102C</b>	Y0007	S-Series high-precision resistor  DSCC 89039 (S102C)	1 Ω to 150 KΩ	±0.005 %	±2 ppm/°C	Up to 100 K: 0.6 W at +70 °C 0.3 W at +125 °C  Over 100 K: 0.4 W at +70 °C 0.2 W at +125 °C	±0.005 %
 <b>S104D</b>	Y0011		1 Ω to 500 KΩ			Up to 200 K: 1 W at +70 °C 0.5 W at +125 °C  Over 200 K: 0.6 W at +70 °C 0.3 W at +125 °C	
 <b>S105D</b>	Y0012		1 Ω to 750 KΩ			Up to 300 K: 1.5 W at +70 °C 0.75 W at +125 °C  Over 300 K: 0.8 W at +70 °C 0.4 W at +125 °C	
 <b>S106D</b>	Y0013		0.5 Ω to 1 MΩ			Up to 400 K: 2 W at +70 °C 1 W at +125 °C  Over 400 K: 1 W at +70 °C 0.5 W at +125 °C	

Uncalibrated S-Series resistors are available.

Uncalibrated S102 chip on strip resistors are available.

\* Tighter performances and higher or lower value resistances are available for all models upon request.

Type	Global Model	Product Description	Resistance Range*	Best Tolerance	TCR (-55 °C to +125 °C, +25 °C ref.) Typical	Rated Power	Load-life Stability, 2000 Hours +125 °C at Rated Power
 S102K	Y0062	S-Series high-precision resistor  DSCC 97009 (S102K)	1 Ω to 100 KΩ	±0.005 %	±1 ppm/°C	Up to 100 K: 0.6 W at +70 °C 0.3 W at +125 °C  Over 100 K: 0.4 W at +70 °C 0.2 W at +125 °C	±0.005 %
 S104K	Y0101		1 Ω to 300 KΩ			Up to 200 K: 1 W at +70 °C 0.5 W at +125 °C  Over 200 K: 0.6 W at +70 °C 0.3 W at +125 °C	
 S105K	Y0102		1 Ω to 500 KΩ			Up to 300 K: 1.5 W at +70 °C 0.75 W at +125 °C  Over 300 K: 0.8 W at +70 °C 0.4 W at +125 °C	
 S106K	Y0103		0.5 Ω to 600 KΩ			Up to 400 K: 2 W at +70 °C 1 W at +125 °C  Over 400 K: 1 W at +70 °C 0.5 W at +125 °C	






Uncalibrated S-Series resistors are available.

\* Tighter performances and higher or lower value resistances are available for all models upon request.








# Selector Guide



## Through-Hole Resistors

Type	Global Model	Product Description	Resistance Range*	Best Tolerance	TCR (-55 °C to +125 °C, +25 °C ref.) Typical	Rated Power	Load-life Stability, 2000 Hours +125 °C at Rated Power
 <b>E102C, E102J</b>	Y1186 Y1184	High-performance resistor High ohmic value, small size	150 K $\Omega$ to 300 K $\Omega$	$\pm 0.005$ %	$\pm 2$ ppm/ $^{\circ}$ C	0.6 W at +70 $^{\circ}$ C 0.3 W at +125 $^{\circ}$ C	$\pm 0.015$ %
 <b>VSR, VSRJ</b>	Y0075 Y0789	VSR Series—industrial precision resistors	1 $\Omega$ to 150 K $\Omega$	$\pm 0.01$ %	$\pm 4$ ppm/ $^{\circ}$ C	Up to 100 K: 0.25 W at +70 $^{\circ}$ C 0.125 W at +125 $^{\circ}$ C  Over 100 K: 0.2 W at +70 $^{\circ}$ C 0.1 W at +125 $^{\circ}$ C	$\pm 0.015$ %
 <b>VSR4</b>	Y0020		1 $\Omega$ to 500 K $\Omega$			Up to 200 K: 0.5 W at +70 $^{\circ}$ C 0.4 W at +125 $^{\circ}$ C  Over 200 K: 0.25 W at +70 $^{\circ}$ C 0.2 W at +125 $^{\circ}$ C	
 <b>VSR5</b>	Y0021		1 $\Omega$ to 750 K $\Omega$			Up to 300 K $\Omega$ : 0.75 W at +70 $^{\circ}$ C 0.6 W at +125 $^{\circ}$ C  Over 300 K $\Omega$ : 0.4 W at +70 $^{\circ}$ C 0.3 W at +125 $^{\circ}$ C	
 <b>VSR6</b>	Y0022		0.5 $\Omega$ to 1 M $\Omega$			Up to 400 K: 1.0 W at +70 $^{\circ}$ C 0.8 W at +125 $^{\circ}$ C  Over 400 K: 0.5 W at +70 $^{\circ}$ C 0.4 W at +125 $^{\circ}$ C	

\* Tighter performances and higher or lower value resistances are available for all models upon request.

Type	Global Model	Product Description	Resistance Range*	Best Tolerance	TCR (-55 °C to +125 °C, +25 °C ref.) Max	Rated Power	Load-life Stability, 2000 Hours +25 °C at Rated Power
 <b>VTA52</b>	Y0028	Tubular axial lead resistors designed to meet or exceed MIL-PRF-39005 requirements	5 Ω to 500 KΩ	±0.01 %	±8 ppm/°C	1 W at +70 °C 0.5 W at +125 °C	±0.05 %
 <b>VTA53</b>	Y0029		5 Ω to 300 KΩ			0.66 W at +70 °C 0.33 W at +125 °C	
 <b>VTA54</b>	Y0054		5 Ω to 300 KΩ			0.5 W at +70 °C 0.25 W at +125 °C	
 <b>VTA55</b>	Y0058		5 Ω to 150 KΩ			0.3 W at +70 °C 0.15 W at +125 °C	
 <b>VTA56</b>	Y0060		5 Ω to 150 KΩ			0.25 W at +70 °C 0.125 W at +125 °C	
 <b>VMTA55</b>	Y0014		5 Ω to 30 KΩ			0.2 W at +70 °C 0.1 W at +125 °C	
 <b>VMTB60</b>	Y0015		5 Ω to 60 KΩ			0.25 W at +70 °C 0.125 W at +125 °C	
<b>VSC-1</b> <b>VSH-1</b>	Y0902 Y0875	Conformally Coated Precision Resistor	5 Ω to 60 KΩ	±0.01 %	±5 ppm/°C	0.3 W at +70 °C	
<b>VSC-2</b> <b>VSH-2</b>	Y0903 Y0934		60 Ω to 120 KΩ				

\* Tighter performances and higher or lower value resistances are available for all models upon request.

## Power Current-Sensing Resistors



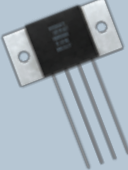

### KEY BENEFITS

- Temperature Coefficient of Resistance (TCR):
  - $\pm 0.05$  ppm/ $^{\circ}\text{C}$  (0  $^{\circ}\text{C}$  to +60  $^{\circ}\text{C}$ ) typical with Z-Foil
  - $\pm 0.2$  ppm/ $^{\circ}\text{C}$  (-55  $^{\circ}\text{C}$  to +125  $^{\circ}\text{C}$ , +25  $^{\circ}\text{C}$  Ref.) typical with Z-Foil
- Power Coefficient (PCR) “ $\Delta R$  due to self heating”: 4 ppm/W or 5 ppm at rated power
- Tolerance: absolute  $\pm 0.01$  %
- Power rating: up to 10 W on heat sink
- Current noise: < -40 dB
- 4 terminal (Kelvin) connections for accuracy
- Any value available within resistance range
- Prototype samples available from 72 hours
- Load Life stability: to  $\pm 0.005\%$  at +25 $^{\circ}\text{C}$ , 200 hours, at rated power
- Rise Time: 1 ns without ringing
- Fast thermal stabilization

### APPLICATIONS

- Military
- Medical
- Aerospace
- Force balance scales
- Electron beam applications
- Switching power supplies
- Electron microscopes
- Gyro navigation controls
- Pressure sensors
- Switching power supplies
- Motor speed controls
- Down-hole (High temperature)
- Weigh Scales



Product	Global Model	Product Description	Resistance Range*	Best Tolerance	TCR (ppm/°C) (-55 °C to +125 °C, +25 °C ref.) Typical	Rated Power at 25 °C	PCR – Power Coefficient
<b>VHP4Z (Z-Foil)</b> 	Y1479	Ultra-high-precision hermetically-sealed power current sense resistor	0.25 Ω to 500 Ω	±0.01 %	±0.2	3 W in free air  10 W on heat sink	4 ppm/W typical
<b>VPR247Z (Z-Foil)</b> 	Y1480	Ultra-high-precision hermetically-sealed power current sense resistor	0.25 Ω to 500 Ω	±0.01 %	±0.2		
<b>VFP4Z (Z-Foil)</b> 	Y1468	Ultra-high-precision power current sense resistor	0.25 Ω to 500 Ω	±0.01 %	±0.2		
<b>VCS331Z, VCS332Z (Z-Foil)</b> 	Y1481 Y1467	Ultra-high-precision power current sense resistor	0.25 Ω to 500 Ω	±0.01 %	±0.2		

\* Tighter performances and higher or lower value resistances are available for all models upon request.

# Selector Guide



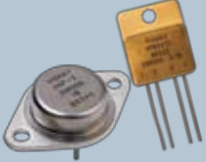
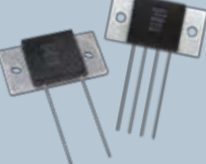


## Power Current-Sensing Resistors

Product	Global Model	Product Description	Resistance Range*	Best Tolerance	TCR (-55 °C to +125 °C, 25 °C Ref.) Typical	Rated Power at 25 °C	PCR – Power Coefficient
 <b>VPR221SZ (Z-Foil)</b>	Y2123	Ultra-high-precision surface-mount power current sense resistor	0.5 Ω to 500 Ω	±0.01 %	±0.2 ppm/°C	8 W on heat sink	4 ppm/W typical
 <b>VPR221Z (Z-Foil)</b>	Y1690	Ultra-high-precision power current sense resistor				1.5 W in free air	
 <b>VPR220SZ (Z-Foil)</b>	Y1623	Ultra-high-precision surface-mount power current sense resistor	5 Ω to 10 KΩ	±0.1%	±0.2ppm/°C	8W on heat sink 1.5 W in free air	
 <b>VPR220Z (Z-Foil)</b>	Y1622	Ultra-high-precision current sense resistor	5 Ω to 10 KΩ	±0.1%	±0.2ppm/°C	8W on heat sink 1.5 W in free air	
 <b>VCS232Z (Z-Foil)</b>	Y1608	Ultra-high-precision power current sense resistor	0.25 Ω to 500 Ω	±0.02 %	±0.2 ppm/°C	2 W maximum current 3 A	
 <b>VCS1625Z** (Z-Foil)</b>	Y1607	Ultra-high-precision surface-mount current sense resistor  DSCC 08003	0.3 Ω to 10 Ω	±0.1 %	±0.2 ppm/°C	0.5 W @ +70 °C maximum current 5 A	

\* Tighter performances and higher or lower value resistances are available for all models upon request.

\*\* VCS1625Z was previously named VCS2516Z



Product	Global Model	Product Description	Resistance Range*	Best Tolerance	TCR (-55 °C to +125 °C Ref. +25 °C) Typical	Rated Power at 25 °C
 <p>VHP3 VHP4 VPR247</p>	Y0065 Y0066 Y0830	Hermetically-sealed and molded power high-precision current sensing resistors	0.05 Ω to 80 KΩ	±0.01 %	±2 ppm/°C	3 W in free air 10 W on heat sink
 <p>VFP3 VFP4</p>	Y0733 Y0734	Molded power high-precision current sensing resistors	0.05 Ω to 80 KΩ	±0.01 %	±2 ppm/°C	3 W in free air 10 W on heat sink
 <p>VCS1625**</p>	Y0850	High-precision current sensing chip resistor (4-terminal)  DSCC 08003	0.01 Ω to 10 Ω	±0.1 %	±2 ppm/°C	0.5 W at +70 °C maximum current 5 A
 <p>VCS101 VCS103 VCS401</p>	Y0930 Y0940 Y0945	Precision, low-value, current sense, shunt resistors, 4-lead Kelvin device	0.005 Ω to 0.25 Ω	±0.1 %	±15 ppm/°C Max. (0 °C to +60 °C)	To 1.5 W in free air maximum current 15 A


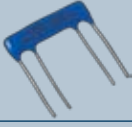
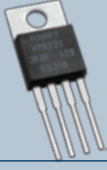

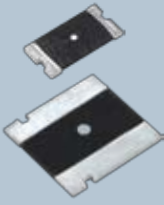
\* Tighter performances and higher or lower value resistances are available for all models upon request.

\*\* VCS1625 was previously named VCS2516

# Selector Guide



## Power Current-Sensing Resistors

Product	Global Model	Product Description	Resistance Range*	Best Tolerance	TCR (-55 °C to +125 °C Ref. +25 °C) Typical	Rated Power at 25 °C
<b>VCS331</b> <b>VCS332</b> 	Y0960 Y0944	Precision power current sensor	0.25 Ω to 500 Ω	±0.1 %	to ±1 ppm/°C Max. (0 °C to +60 °C)	10 W on heat sink 3 W in free air maximum current 5 A
<b>VCS301</b> <b>VCS302</b> 	Y0959 Y0943	High-precision Current Sensing Resistors (4-Terminal)	0.005 Ω to 0.25 Ω	±0.5 %	to ±3 ppm/°C Max. (0 °C to +60 °C)	10 W on heat sink 3 W in free air maximum current 15 A
<b>VCS201</b> <b>VCS202</b> 	Y0955 Y0941	Precision current sensing resistors, conformally coated	0.005 Ω to 0.2 Ω	±0.1 %	±15 ppm/°C	To 2 W in free air maximum current to 15 A
<b>VPR221</b> 	Y0926	High-precision power resistors in TO-220 configuration, 4-lead kelvin connected device (Surface-Mount version VPR221S)	0.5 Ω to 500 Ω	±0.01 %	±2 ppm/°C	8 W on heat sink 1.5 W in free air maximum current 3 A
<b>VPR220</b> 	Y0925	High-precision power resistor in to TO-220 configuration (SMD version VPR220S)	5 Ω to 10 KΩ	±0.01 %	±2 ppm/°C	8 W on heat sink 1.5 W in free air maximum current 3A
<b>CSM2512</b> <b>CSM3637</b> 	Y1487 Y1488	High-precision metal strip resistor (4-terminal)  DSCC 07011* (CSM2512)  DSCC 07012* (CSM3637)  EEE-INST-002:  MIL-PRF49464 MIL-PRF55342	0.002 Ω to 0.2 Ω	±0.1 %	±15 ppm/°C Max.	Up to 3 W maximum current 38 A

\* Spec for space also available.

\* Tighter performances and higher or lower value resistances are available for all models upon request.

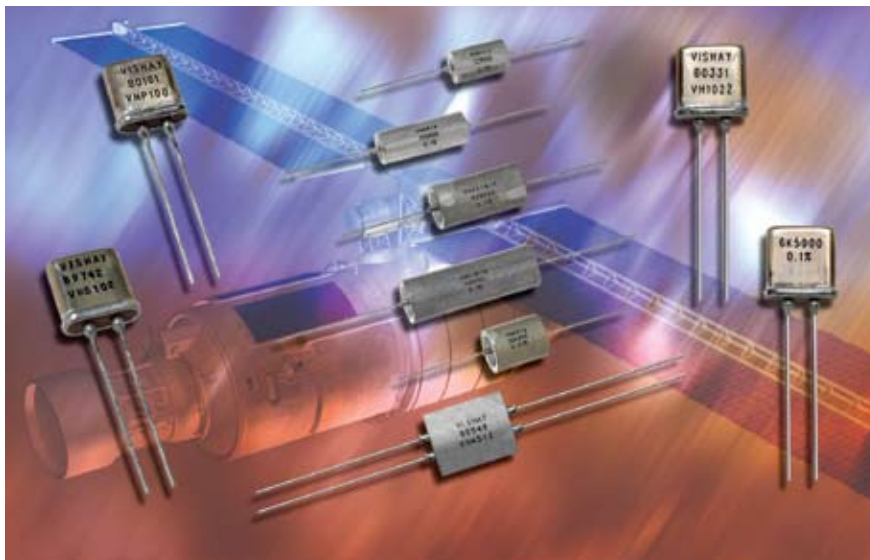
## Hermetically-Sealed Resistors

### KEY BENEFITS

- TCR:  $\pm 0.05$  ppm/ $^{\circ}\text{C}$  (0  $^{\circ}\text{C}$  to +60  $^{\circ}\text{C}$ ) Typical
- Available with tight TCR window in working temperature range (e.g. 10 ppm window from +15  $^{\circ}\text{C}$  to +45  $^{\circ}\text{C}$ ) (Contact Application Engineering)
- Tolerance:  $\pm 0.001$  %
- PCR: 5 ppm at rated power
- Load-life stability: to  $\pm 0.005$  % +125  $^{\circ}\text{C}$ , 2000 hours at rated power
- Resistance range: any value from 1  $\Omega$  to 3.3 M $\Omega$
- Available with 4-terminal (Kelvin) connections
- **Shelf-life stability: 2 ppm after at least 10 years**
- Oil-filled for ultra hermetically (also available without oil)
- Non-inductive, non-capacitive design
- Prototype samples available from 72 hours
- **Available with laboratory and metrology level precision and long term stability with additional in-house oriented processes, such as:**
  - Special TCR plotting
  - Mounted chip stabilization
  - Thermal shock and bake prior to sealing
  - Combined thermal shock and power conditioning on finished product
  - Thermal and power conditioning
- Certification to NIST standards available

### APPLICATIONS

- Metrology
- Military
- Aerospace
- Medical
- Test equipment
- Instrumentation amplifiers
- Laboratory
- Industrial
- Measurements systems



# Selector Guide



## Hermetically-Sealed Resistors

Product	Global Model	Product Description	Resistance Range*	Best	TCR (-55 °C to +125 °C, +25 °C ref.) Typical	Rated Power at +70 °C	PCR (at Rated Power)
VH102Z (Z Foil)	Y5077	Hermetic version of the molded Z201 and Z555 devices	10 Ω to 100 KΩ	±0.005 %	±0.2 ppm/°C Available with low window TCR over the required temp. range	0.6 W	5 ppm typical
VHZ555 (Z Foil)			4.99 Ω to 121 KΩ	±0.005 %	±0.2 ppm/°C	0.6 W	5 ppm typical
VHP202Z (Z Foil)	Y1748	Oil-Filled Hermetically Sealed Ultra-High Precision Resistors	5 Ω to 100 kΩ	±0.001 % (1 K to max value)	±0.2 ppm/°C	0.3 W	5 ppm typical
VHA412Z (Z Foil)	Y1749		5 Ω to 200 kΩ			0.5 W	
VHA414Z (Z Foil)	Y1751		5 Ω to 300 kΩ			0.75 W	
VHA512Z (Z Foil)	Y1750		5 Ω to 400 kΩ			1.0 W	
VHA516-4Z*** (Z Foil)	Y1752		5 Ω to 500 kΩ			1.25 W	
VHA516-5Z*** (Z Foil)	Y1753		5 Ω to 600 kΩ			1.5 W	
VHA516-6Z*** (Z Foil)	Y1754		5 Ω to 700 kΩ			1.75 W	
VHA518-7Z*** (Z Foil)	Y1755		5 Ω to 800 kΩ			2.0 W	
VHA518-8Z*** (Z Foil)	Y1756		5 Ω to 900 kΩ			2.25 W	
VHA518-9Z*** (Z Foil)	Y1757		5 Ω to 1.0 MΩ			2.5 W	
VHA518-10Z*** (Z Foil)	Y1758		5 Ω to 1.1 MΩ				
VHA518-11Z*** (Z Foil)	Y1759						
VHS102	Y0077	Hermetic version of the molded S102C and S555 devices	1 Ω to 150 KΩ	±0.005 %	±2 ppm/°C	0.6 W	
VHS555	Y0087						

\* Tighter performances and higher or lower value resistances are available for all models.

\*\* VHP203 is a miniature version of VHP202Z

\*\*\* Available in 4-lead terminal:

VHA512(Z) please use 302073(Z)

VHA516(Z) please use 302074(Z)

VHA518(Z) please use 302075(Z)

Product	Global Model	Product Description	Resistance Range*	Best	TCR (-55 °C to +125 °C, +25 °C ref.) Typical	Rated Power at +70 °C	PCR (at Rated Power)
VHP100 VHP102 (0.2" L.S.)  VHP101 VHP103 (0.2" L.S.)	Y0078 Y5078  Y4078 Y6078	Ultra-high-precision resistor with very narrow TCR window	100 Ω to 150 KΩ	±0.005 %	60 ppm max window over temperature range of -55 °C to +125 °C	0.3 W at +70 °C	5 ppm typical



Product	Global Model	Product Description	Resistance Range*	Best Tolerance	TCR (-55 °C to +125 °C, +25 °C ref.) Typical	Rated Power at +70 °C
VHP202	Y0024	Oil-filled hermetically sealed high-precision resistors  (4-lead terminal (Kelvin connection) available on special request)	5 Ω to 150 KΩ	±0.001 % (1 K to max value)	±2 ppm/°C	0.3 W
VHA412	Y0019		5 Ω to 335 KΩ			0.5 W
VHA414	Y0025		5 Ω to 500 KΩ			0.75 W
VHA512**	Y0023		5 Ω to 668 KΩ			1.0 W
VHA516-4**	Y0104		5 Ω to 835 KΩ			1.25 W
VHA516-5**	Y0105		5 Ω to 1 MΩ			1.5 W
VHA516-6**	Y0106		5 Ω to 1.17 MΩ			1.75 W
VHA518-7**	Y0107		5 Ω to 1.34 MΩ			2.0 W
VHA518-8**	Y0108		5 Ω to 1.5 MΩ			2.25 W
VHA518-9**	Y0109		5 Ω to 1.67 MΩ			2.5 W
VHA518-10**	Y0110		5 Ω to 1.84 MΩ			
VHA518-11**	Y0111					



\* Tighter performances and higher or lower value resistances are available for all models.

\*\* Available in 4-lead terminal:

VHA512(Z) please use 302073(Z)  
VHA516(Z) please use 302074(Z)  
VHA518(Z) please use 302075(Z).

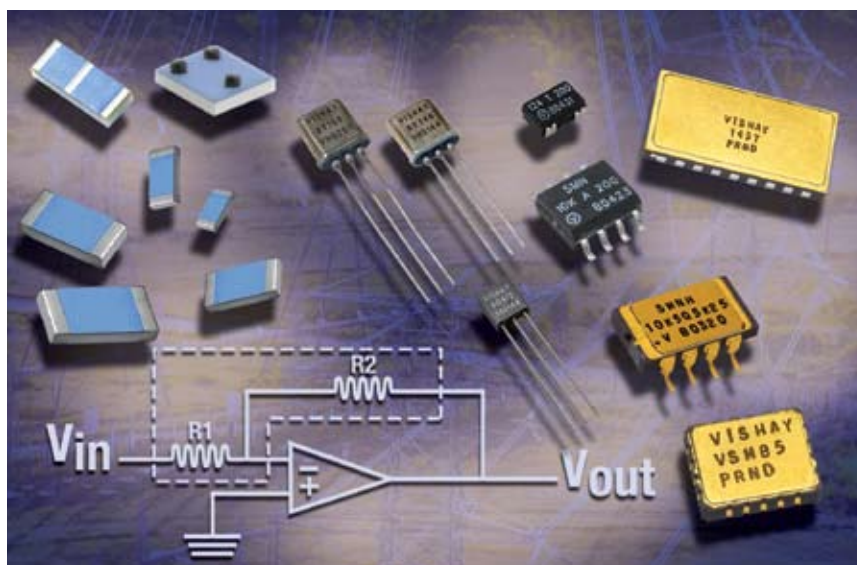
## Voltage Dividers and Resistor Networks


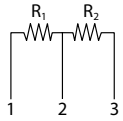

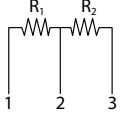

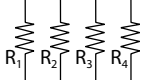

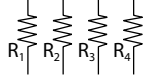
### KEY BENEFITS

- Absolute Temperature Coefficient of Resistance (TCR):
  - $\pm 0.05$  ppm/ $^{\circ}\text{C}$  (0  $^{\circ}\text{C}$  to +60  $^{\circ}\text{C}$ ) typical with Z-Foil
  - $\pm 0.2$  ppm/ $^{\circ}\text{C}$  (-55  $^{\circ}\text{C}$  to +125  $^{\circ}\text{C}$ , +25  $^{\circ}\text{C}$  Ref.) typical with Z-Foil
- TCR Tracking: 0.1 ppm/ $^{\circ}\text{C}$
- Power Coefficient of Resistance (PCR) tracking “ $\Delta R$  due to self heating”: 5 ppm at rated power
- Absolute tolerance:  $\pm 0.005$  %
- Ratio match:  $\pm 0.001$  % (10 ppm)
- Ratio stability:  $< \pm 0.001$  % (10 ppm)
- Rated power up to 0.75 W at 70  $^{\circ}\text{C}$
- Thermal EMF: 0.05  $\mu\text{V}/^{\circ}\text{C}$
- Current noise:  $< -40$  dB
- Shelf-life stability: 2 ppm for hermetically sealed resistors
- Any ratio available within resistance range
- Prototype samples available from 72 hours

### APPLICATIONS

- Military
- Aerospace and Avionics
- Automotive
- Telecommunications
- Industrial
- Medical
- Test equipment
- Instrumentation
- High-precision amplifiers
- Laboratory
- Audio
- Electron beam applications
- Bridge networks
- Differential amplifiers
- Weigh scales
- Down-hole (High Temperature)



Model and Product Description	Global Model	Resistance Range	Resistance Ratios Available	Best Resistance Tolerance		TCR (-55 °C to +125 °C +25 °C ref.) Typical	Rated Power (+70 °C)	PCR Tracking
				Absolute	Ratio Match			
<b>DSMZ (Z-Foil)</b> Ultra-High precision  Surface-mount, molded voltage divider  	<b>Y4485</b>	Any value 100 Ω to 10 KΩ per resistor  	Any ohmic value ratio within resistance range	±0.02 %	0.01 %	Absolute: ±0.2 ppm/°C  Tracking: 0.1 ppm/°C	Entire package 0.1 W  Each resistor 0.05 W at 70 °C	5 ppm at rated power
<b>DSM</b> High precision  Surface-mount, molded voltage divider  	<b>Y1485</b>	Any value 100 Ω to 20 KΩ per resistor  		±0.02 %	0.01 %	Absolute: ±2 ppm/°C  Tracking: < 0.5 ppm/°C	Entire package 0.1 W  Each resistor 0.05 W at 70 °C	
<b>SMNZ (Z-Foil)</b> Ultra-High precision  Surface-mount, 4-resistor network dual in-line, molded package, 50 mil pitch  	<b>Y1747</b>	Any value 100 Ω to 10 KΩ per resistor  		±0.02 %	0.01 %	Absolute: ±0.2 ppm/°C  Tracking: 0.1 ppm/°C	Entire package 0.4 W  Each resistor 0.1 W at 70 °C	5 ppm at rated power
<b>SMN</b> High precision  Surface-mount 4-resistor network dual in-line, molded package, 50 mil pitch  	<b>Y1365</b>	Any value 100 Ω to 20 KΩ per resistor  		±0.02 %	0.01 %	Absolute: ±2 ppm/°C  Tracking: < 0.5 ppm/°C	Entire package 0.4 W  Each resistor 0.1 W at 70 °C	

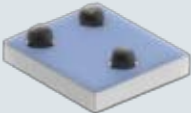
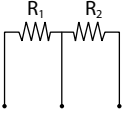
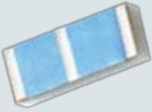
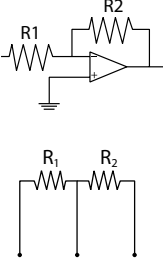
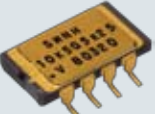
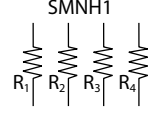
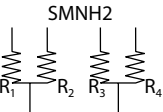

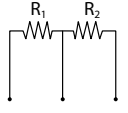
\* Tighter performances and higher or lower value resistances are available for all models.



# Selector Guide



## Voltage Dividers and Resistor Networks


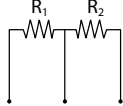


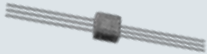


Model and Product Description	Global Model	Resistance Range	Resistance Ratio Available	Best Resistance Tolerance		TCR (-55 °C to +125 °C +25 °C ref.) Typical	Rated Power +70 °C	PCR Tracking
				Absolute	Ratio Match			
<b>VFB1012D (Z-Foil)</b> Ultra-high-precision Ball Grid Array (BGA) surface-mount, voltage divider 	<b>Y1683</b>	1 K $\Omega$ to 10 k $\Omega$ 	Any ohmic value ratio within resistance range	$\pm 0.01\%$	0.01 %	Absolute: $\pm 0.2$ ppm/ $^{\circ}$ C Tracking: 0.1 ppm/ $^{\circ}$ C	0.2 W at +70 °C, for the entire package divided proportionally between the two elements	5 ppm at rated power
<b>VFCD1505 (Z Foil)</b> Ultra-high-precision flip-chip, voltage divider 	<b>Y1685</b>	10 $\Omega$ to 40 K $\Omega$ 		$\pm 0.01\%$	0.01 % ( $\pm 0.005\%$ is available)	Tracking: 0.1 ppm/ $^{\circ}$ C	0.1 W at +70 °C, for the entire package divided proportionally between the two elements	
<b>SMNH1, 2*,**</b> High precision, hermetically sealed, 4-resistors, surface mount resistor network 	<b>Y1521</b> Y1522	Any value 5 $\Omega$ to 33 K $\Omega$ per resistor SMNH1  SMNH2 		$\pm 0.005\%$	0.005 %	Absolute : $\pm 2$ ppm/ $^{\circ}$ C Tracking: < 0.5 ppm/ $^{\circ}$ C	Entire package 0.4 W Each resistor 0.1 W at 70 °C	
<b>300144Z (Z-Foil)</b> Ultra-high-precision, Small package molded voltage divider 	<b>Y1691</b>	Any value from 100 $\Omega$ to 20 K $\Omega$ per resistor 		$\pm 0.005\%$	0.01 %	Absolute: $\pm 0.2$ ppm/ $^{\circ}$ C Tracking: 0.1 ppm/ $^{\circ}$ C	0.2 W at +70 °C, for the entire package divided proportionally between the two elements	5 ppm at rated power

\* Shelf life stability: 2 ppm

\*\* Available with Z-Foil technology.

Tighter performances and higher or lower value resistances are available for all models.



Model and Product Description	Global Model	Resistance Range	Resistance Ratio Available	Best Resistance Tolerance		TCR (-55 °C to +125 °C +25 °C ref.) Typical	Rated Power +70 °C	PCR Tracking
				Absolute	Ratio Match			
<b>300144</b> High precision  Small package molded voltage divider  	<b>Y0006</b>	Any value from 100 Ω to 20 KΩ per resistor DSCC 87026  	Any ohmic value ratio within resistance range	±0.005 %	0.005 %	Absolute: ±2 ppm/°C  Tracking: 0.5 ppm/°C	0.2 W at +85 °C, for the entire package divided proportionally between the two elements	
<b>300145Z (Z-Foil)</b> Ultra-high-precision  Small package molded pair of voltage dividers  	<b>Y1735</b>	Any value from 100 Ω to 20 KΩ per resistor  		±0.005 %	0.01 %	Absolute: ±0.2 ppm/°C  Tracking: 0.1 ppm/°C	0.2 W at +70 °C, for the entire package divided proportionally between the two elements	5 ppm at rated power
<b>300145</b> High precision  Small package molded pair of voltage dividers  	<b>Y0035</b>	Any value from 100 Ω to 20 KΩ per resistor  		±0.005 %	0.005 %	Absolute: ±2 ppm/°C  Tracking: 0.5 ppm/°C	0.2 W at +85 °C (per voltage divider)	
<b>300190Z-9Z, 300210Z-12Z (Z-Foil)</b> Ultra-High-Precision  Molded resistor networks 2R, 3R, 4R, voltage dividers, bridge circuits, attenuators  	<b>Refer to datasheet</b>	Any value from 1 Ω to 150 KΩ per resistor		±0.005 %	0.01 %	Absolute: ±0.2 ppm/°C  Tracking: 0.1 ppm/°C	0.6 W at 70 °C 0.3 W at 125 °C	5 ppm at rated power

300144 uncalibrated resistors are available.

\* Shelf life stability: 2 ppm



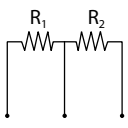

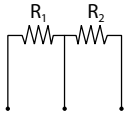

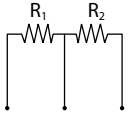
\*\* Available with Z-Foil technology.

Tighter performances and higher or lower value resistances are available for all models.

# Selector Guide



## Voltage Dividers and Resistor Networks

Model and Product Description	Global Model	Resistance Range	Tolerance	Best Resistance Tolerance		TCR (-55 °C to +125 °C +25 °C ref.) Typical	Rated Power at 70 °C	PCR Tracking
				Absolute	Ratio Match			
<b>300190–9, 300210–12 Networks</b> High Precision  Molded resistor networks 2R, 3R, 4R, voltage dividers, bridge circuits, attenuators  	Refer to datasheet	Any value from 1 Ω to 150 KΩ per resistor	Any ohmic value ratio within resistance range	±0.005 %	0.005 %	Absolute: ±2 ppm/°C  Tracking: 0.5 ppm/°C	0.5 W per resistor at +70 °C  0.25 W per resistor at +125 °C	
<b>VSR144</b> Industrial molded voltage divider  	Y0094	Any value 100 Ω to 20 KΩ  		±0.05 %	0.02 %	Absolute : ±4 ppm/°C  Tracking: 1.5 ppm/°C	0.2 W at +85 °C	
<b>VHD144*, **</b>  Hermetic version of the molded divider 300144  	Y0076	Any value from 100 Ω to 20 KΩ per side  		±0.005 %	0.005 %	Absolute: ±2 ppm/°C  Tracking: 0.5 ppm/°C	0.2 W at +85 °C	
<b>VHD200*, **</b>  Hermetic sealed oil-filled voltage divider, ultimate ratio match and TC tracking  	Y5076	Any value from 100 Ω to 20 KΩ per side  		±0.005 %	0.001 %	Absolute: ±2 ppm/°C  Tracking: 0.1 ppm/°C	0.2 W at +85 °C	

\* Shelf life stability: 2 ppm

\*\* Available with Z-Foil technology.

Tighter performances and higher or lower value resistances are available for all models.

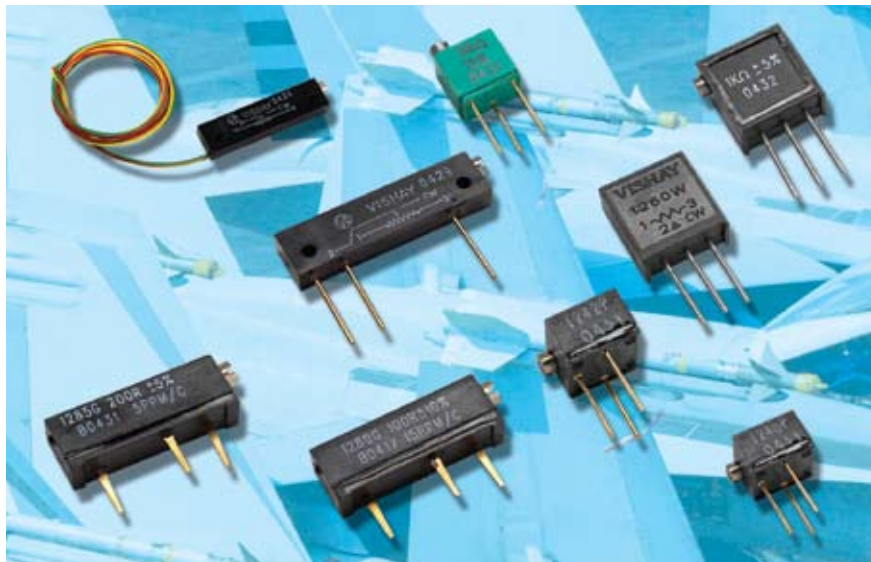
## Trimming Potentiometers

### KEY BENEFITS

- TCR Absolute (end to end):  $\pm 5$  ppm/ $^{\circ}\text{C}$  ( $-55$   $^{\circ}\text{C}$  to  $+125$   $^{\circ}\text{C}$ ,  $+25$   $^{\circ}\text{C}$  ref.)
- TCR through the wiper:  $\pm 25$  ppm/ $^{\circ}\text{C}$
- Settability: down to  $\pm 0.005$  %
- Setting stability: to 0.1 %
- Load-life stability: 20 ppm
- Tap test: 0.05 %
- All trimmers undergo noise and linearity tests during the standard production process
- "O" Ring prevents ingress of fluids during any board cleaning operation
- Prototype samples available from 48 hours

### APPLICATIONS

- High-precision instrumentation
- Test equipment, and automatic test equipment
- Laboratory and industrial
- Audio equipment
- Military



# Selector Guide



## Trimming Potentiometers

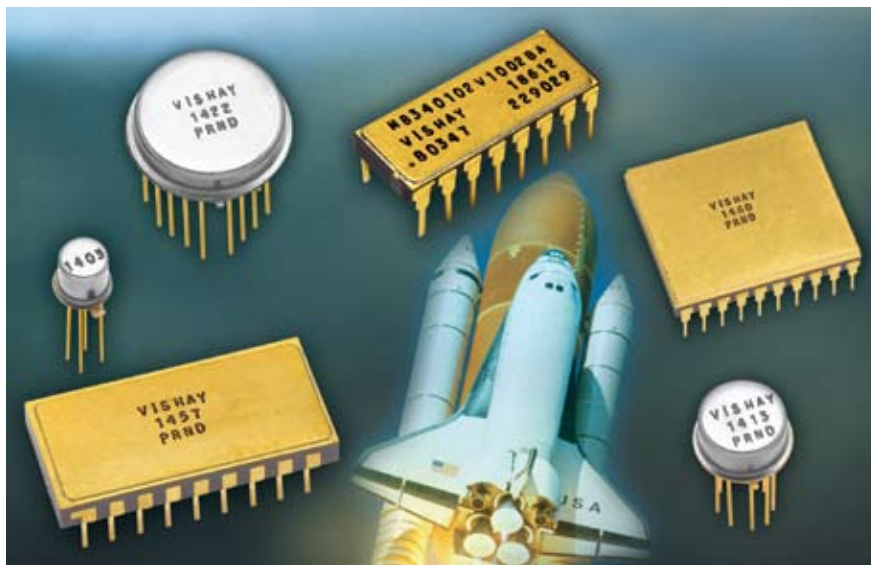
Type	Global Model	Product Description	Resistance Range*	Best Tolerance	TCR (-55 °C to +150 °C +25 °C ref.)	Rated Power	Termination Style
 <p><b>1240</b></p>	<p><b>Y4053</b> <b>Y5053</b> <b>Y0053</b></p>	<p>Precision Trimming Potentiometers, 1/4 inch square, RJ26 style DSCC 87126</p>	5 Ω to 10 KΩ	±5 %	±10 ppm/°C	0.25 W at +85 °C	<p>W-edge mount, top adjust X-edge mount, side adjust P-horizontal mount, side adjust</p>
 <p><b>1260</b></p>	<p><b>Y0069</b> <b>Y4069</b></p>	<p>Precision Trimming Potentiometers, 3/8 inch square, RJ24 style</p>	5 Ω to 10 KΩ	±5 %	±10 ppm/°C	0.25 W at +85 °C	<p>W-edge mount, top adjust X-edge mount, side adjust</p>
 <p><b>1202</b></p>	<p><b>Y0051</b> <b>Y5051</b> <b>Y5050</b></p>	<p>Precision Trimming Potentiometers, 1 1/4 inch rectilinear, RJ12 style</p>	2 Ω to 20 KΩ	±5 %	±10 ppm/°C	0.5 W at +85 °C	<p>P-in line PC pins Y-staggered PC pins L-flexible wire leads with bushings</p>
 <p><b>1242</b></p>	<p><b>Y0056</b></p>	<p>Precision Trimming Potentiometers QPL, 1/4 inch square, qualified to MIL-PRF-22097, Char. F, RJ26</p>	50 Ω to 5 KΩ	±10 %	±10 ppm/°C	0.25 W at +85 °C	<p>W-edge mount, top adjust X-edge mount, side adjust</p>
 <p><b>1280G</b></p>	<p><b>Y0059</b></p>	<p>Precision Trimming Potentiometers, 3/4 inch rectilinear</p>	10 Ω to 20 KΩ	±10 %	±15 ppm/°C	0.75 W at +25 °C	
 <p><b>1285G</b></p>			10 Ω to 20 KΩ	±5 %	±5 ppm/°C	0.75 W at +25 °C	

\* Tighter performances and higher or lower value resistances are available for all models.

## Hybrid Chips and Custom Designed Hermetically-Sealed Networks

### KEY BENEFITS

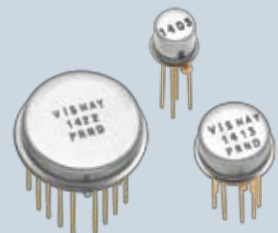
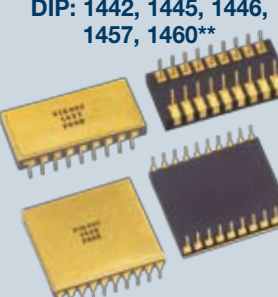
- TCR:  $\pm 2$  ppm/ $^{\circ}\text{C}$  (-55  $^{\circ}\text{C}$  to +125  $^{\circ}\text{C}$ , +25 $^{\circ}\text{C}$  ref.)
- TCR tracking: 0.5 ppm/ $^{\circ}\text{C}$
- Flexible schematic designs
- Tolerance: absolute  $\pm 0.005$  %; match 0.002 %
- Any combination of resistance values: 5  $\Omega$  to 80 k $\Omega$
- Load-Life Stability (> 1000 hrs at rated power):  $\Delta R = 0.01$  %,  $\Delta \text{Ratio} = 0.005$  %
- High degree of hermeticity:  $< 5 \times 10^{-7}$  cc/sec
- Rated power per package up to 2.4 W
- No engineering charges, no minimum quantities
- Quick prototype delivery
- Custom designed chip arrays are available



# Selector Guide



## Hybrid Chips and Custom Designed Hermetically–Sealed Networks

Hybrid Chip Type	Global Model	Product Description	Resistance Range*	Best Tolerance	TCR Typical	Temperature Range	Rated Power at +70 °C
V5x5PT (0.050" x 0.050")	Y4045	Hybrid chips (gold-plated termination pads)	5 Ω to 10 KΩ	±0.005 %	±2 ppm/°C	-55 °C to +125 °C, Ref. +25 °C	0.05 W
V15x5PT (0.150" x 0.050")	Y4047		5 Ω to 33 KΩ				0.1 W
V15x10PT (0.150" x 0.100")	Y4475		33 KΩ to 80 KΩ				0.15 W
V5X5PU	Y4044	Untrimmed gold wire-bondable hybrid chips (gold-plated termination pads)	Good for 5 Ω to 10 KΩ				0.05 W
V15X5PU	Y4046		Good for 5 Ω to 33 KΩ				0.1 W
V15X10PU	Y4471		Good for 33 Ω to 80 KΩ				0.15 W
Package Type	Product Description		Resistance Range*	Best Tolerance		TCR (-55 °C to +125 °C, +25 °C Ref.) Typical	
TO: 1401, 1403, 1413, 1417, 1419, 1421, 1422** 	Glass to metal seal headers		5 Ω to 80 KΩ per resistor	Absolute: ±0.005 %		Absolute: ±2 ppm/°C	
DIP: 1442, 1445, 1446, 1457, 1460** 	Ceramic dual-in-line package			Ratio match: 0.002 %		Tracking: 0.5 ppm/°C	

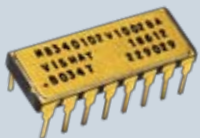
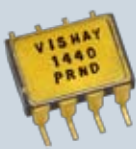

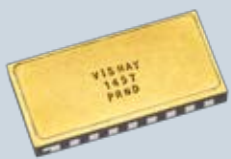
Uncalibrated Hybrid Chips are available.

\* Tighter performances and higher or lower value resistances are available for all models.

\*\* Shelf-life stability: 2 ppm

Revision Date 08–April–11

www.vishay.com

Package Type	Product Description	Resistance Range*	Best Tolerance	TCR (-55 °C to +125 °C, +25 °C Ref.) Typical
<b>1445Q (7 resistors)**</b> <b>1446Q (8 resistors)**</b> 	Networks qualified to MIL-PRF 83401 Characteristic "c" Schematic A	100 Ω to 10 KΩ	Absolute: ±0.1 %  Ratio match: 0.1 %	Absolute: ±50 ppm/°C  Tracking: 5 ppm/°C
<b>VSM40, 42, 45, 46**</b> (8, 14 and 16 pin) 	Hermetic resistor networks in gull wing configuration			
<b>VSM85, 86, 87, 88, 89**</b> 	Hermetic resistor networks in leadless chip carrier (LCC) configuration	5.0 Ω to 80 KΩ	Absolute: ±0.005 %  Match: ±0.002 %	Absolute: ±2 ppm/°C  Tracking: < 0.5 ppm/°C
<b>VSM57**</b> 				

Uncalibrated Hybrid Chips are available.

Networks are built to customer requirements. Send your schematics and electrical specification to Application Engineering Department at [foil@vishay.com](mailto:foil@vishay.com)

\* Tighter performances and higher or lower value resistances are available for all models.

\*\* Shelf-life stability: 2 ppm



## Military and Aerospace

### Established Reliability (ER)

The RNC90Y established reliability resistor has been the benchmark for high precision established reliability discrete resistors since 1982. In 2000, Vishay achieved a technological breakthrough with the introduction of the Z201 resistor with a TCR of 0.2 PPM/°C. This breakthrough has allowed Vishay to introduce the RNC90Z established reliability “R” level resistor, with a TCR limit of  $\pm 2$  ppm/°C over the extended range of - 55°C to + 175°C, this being a significant improvement over the existing RNC90Y’s  $\pm 5$  ppm/°C TCR specification.

Model	Failure Rate	Mil Spec No.	Resistance Range ( $\Omega$ )	TCR (Mil Range)	Absolute Tolerance	Termination Type
RNC90Y	LEVEL R	MIL-PRF-55182/9	4R99 - 121 K	$\pm 5$ ppm/°C	0.005 %	Lead
RNC90T*						
RNC90Z			30R1 - 121 K	$\pm 2$ ppm/°C	0.01 %	
RNC90S*						

\*0.200” lead spacing

### QPL

Vishay Models 1445Q and 1446Q networks are qualified to MIL-PRF-83401, Characteristic C, Schematic A. Actual performance exceeds all the requirements of MIL-PRF-83401 characteristics “C.”

Model	Mil Spec No.	Termination Type	Resistance Range	Absolute Tolerance	No. of Resistors	Absolute TCR (Mil Range)
1445Q	MIL-PRF-83401	14 pin DIP	100 R - 10 K	0.1 %	7	100 R - 1 K 10 ppm/°C
1446Q		16 pin DIP			8	1 K - 10 K 5 ppm/°C

Vishay model RJ26 Precision Trimming ¼ inch Potentiometer is qualified to Mil-PRF-22097

Model	Mil Spec No.	Termination Type	Resistance Range	Absolute Tolerance	Setability	TCR Through the Wiper (-55 °C to +125 °C, +25 °C Ref)
RJ26	MIL-PRF-22097	Leaded	50 R, 100 R 200 R, 500 R, 1 K, 2 K, 5 K	10%	0.05 %	$\pm 25$ ppm/°C

## DSCC Approved

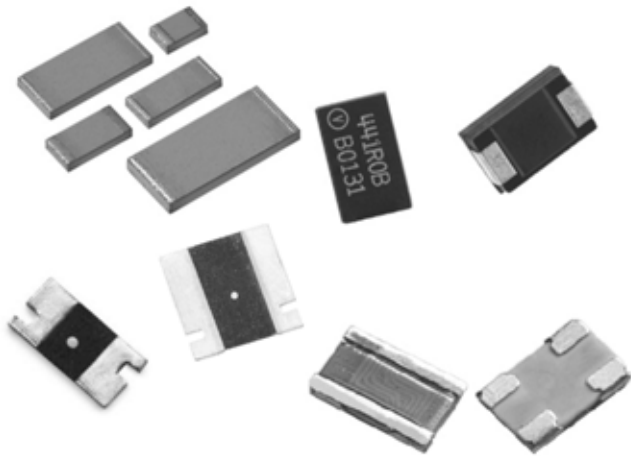
The Defense Supply Center Columbus (DSCC) is known to more than 24,000 military and civilian customers, plus 10,000 contractors as one of the largest suppliers of weapons systems spare parts. The DSCC has officially approved a number of BMF resistors per relevant Mil specs:

Model	DSCC and Mil Spec No.	Termination Type	Resistance Range	Absolute Tolerance	Typical Absolute TCR (-55 °C to + 125 °C, + 25 °C ref.)
CSM2512	07011 MIL-PRF-49465	Surface Mount	0.003 Ω - 0.2 Ω	±0.5 %	±15 PPM/°C Max
CSM3637	07012 MIL-PRF-49465		0.002 Ω - 0.2 Ω		
VSMP0805 / VSM0805	07024 MIL-PRF-55342	Wraparound Surface Mount	10 Ω - 12 KΩ	±0.1 %	±0.2 PPM/°C (VSMP)
VSMP1206 / VSM1206	07025 MIL-PRF-55342		10 Ω - 30 kΩ		
VSMP1506 / VSM1506	03010 MIL-PRF-55342		10 Ω - 40 kΩ		
VSMP2010 / VSM2010	06001 MIL-PRF-55342		10 Ω - 100 kΩ		
VSMP2512 / VSM2512	06002 MIL-PRF-55342		10 Ω - 150 KΩ		

The Defense Supply Center Columbus (DSCC) is known to more than 24,000 military and civilian customers, plus 10,000 contractors as one of the largest suppliers of weapons systems spare parts. The DSCC has officially approved a number of BMF resistors per relevant Mil specs:

Model	DSCC and Mil Spec No.	Termination Type	Resistance Range	Absolute Tolerance	Typical Absolute TCR (-55 °C to + 125 °C, + 25 °C ref.)
SMR1DZ / SMR1D	06020 MIL-PRF-55182	Molded Surface Mount with flexible terminations	5 Ω - 33 kΩ	±0.1 %	±0.2 PPM/°C (SMR1DZ)
SMR3DZ / SMR3D	06021 MIL-PRF-55182		5 Ω - 80 kΩ		±0.2 PPM/°C (SMR3DZ)
VFCP1206	02009 MIL-PRF-55342	Flip Chip Surface Mount	10 Ω - 30 kΩ		±0.2 PPM/°C
300144 (or 300144Z with Z-Foil)	87026 MIL-PRF-55182	Leaded	100 Ω - 20 kΩ	0.005 % Match	±0.2 PPM/°C 0.1 PPM/°C Tracking
1240 Trimmer	87126 MIL-PRF-39035		5 Ω - 10 kΩ	±5 %	±10 PPM/°C
S102C	89039 MIL-PRF-55182		1 Ω - 150 kΩ	±0.005 %	±2 PPM/°C
VCS1625Z / VCS1625	08003 MIL-PRF-55342	Surface Mount	0.01 Ω - 10 Ω	±0.5 %	±0.2 PPM/°C (VCS1625Z)

## Vishay Foil Surface Mount Resistors (Military and Space Applications)



Vishay Foil Resistors can be manufactured with any resistance value within the given resistance range (i.e. 1 k $\Omega$  or 1K1234 k $\Omega$ ) without influencing cost or lead time.

### INTRODUCTION

Many manufacturers and users of precision electronic equipment suffer unnecessarily with unexplained instabilities and drifts. They resign themselves to the need for constant adjustments and troubleshooting which could in fact be avoided.

Often the instability is traceable to a few "fixed" resistors which are not fixed at all. If these resistors would only retain their original values, there would be no need for costly controls and other compensating circuitry.

The answer? A real precision and stable resistor.

Some precision resistors offer you tight tolerance at the expense of poor load life stability (1000 h or more), thermal stabilization and ESD sensitivity, other offers low TCR at the expense of poor rise time.

Only Vishay Bulk Metal<sup>®</sup> Foil resistors offer you the complete set of top performance characteristics, including TCR as low as 0.2 ppm/ $^{\circ}$ C with the Z-foil technology, a combination that will most often free your equipment from that tormenting bug.

Vishay now offers you the chance to make your own custom bulk-metal resistors for breadboard, prototype, or even production use.

Call or write for information about our resistors:  
[foil@vishay.com](mailto:foil@vishay.com)

### FEATURES

- Temperature coefficient of resistance (TCR) from 0.2 ppm/ $^{\circ}$ C (military range) with the Z-foil technology
- Load life stability: to 0.005 % at + 70  $^{\circ}$ C, at rated power for more than 10 000 h
- Tolerance: best to 0.01 %
- Power coefficient ( $\Delta R$  due to self heating): to 5 ppm at rated power for Z-foil resistors
- Resistance range: 2 m $\Omega$  to 150 k $\Omega$
- Electrostatic discharge (ESD) immunity up to 25 000 V
- Fast terminal stabilization < 1 s
- Rise time: 1 ns without ringing
- Thermal EMF < 0.1  $\mu$ V/ $^{\circ}$ C (Seebeck effect), especially critical for low resistive value in DC current/voltage
- Any value is available within the resistance range
- Special non inductive and non capacitive design
- The short time overload test is also part of the standard production process (100 %)
- Vishay Foil Resistors have been radiation tested
- All resistors in this group carry a low weight
- Prototype samples available from 72 h
- There are four main factors which should be considered when designing a board: TCR, PCR, thermal EMF and ESD. Vishay Foil Resistors provide the best combination of the above factors
- Data package and test results are available, please contact us ([foil@vishay.com](mailto:foil@vishay.com))

### APPLICATIONS

Dc-to-dc converters, feedback circuits, precision amplifiers in test and measurement instrumentation, medical systems, satellites and aerospace systems, commercial and military avionics, weapons systems, audio systems, and high-temperature systems including down-hole drilling.



### ABOUT THE VISHAY BULK METAL® FOIL RESISTOR

Vishay low cost high precision Bulk Metal Foil resistors are the result of an improved concept in resistor manufacturing: a proprietary Bulk Metal Foil of known and controllable properties is applied to a special ceramic substrate.

A resistive pattern is then photo-etched by an ultra-fine technique developed by Vishay. This process results in resistor element characteristics of low TCR, long term stability, non inductive, excellent thermal stabilization, low capacitive and low noise.

The Bulk Metal Foil is a special alloy chosen for its electrical mechanical and thermal characteristics. It is set on the substrate by a unique and proprietary process which does not subject the resistor element to the metallurgical changes that occur during the winding of wire, or during the evaporative process used in other forms of precision resistors manufacture. Because the alloy in the Vishay resistor is not drawn, wound, work hardened, or stressed in any way during manufacturing process, the resistor maintains all of its original design, physical and electrical characteristics. Each step of manufacture is rigidly controlled, with extensive quality control ensuring that the alloy is kept in its virgin state. The temperature coefficient of the resistor is carefully controlled through compensating techniques which essentially eliminates the effects of the different coefficients of expansion of the materials used in the resistor.

### CUSTOM PRODUCT DESIGN

Customers who require additional performance tests are encouraged to contact our application engineers. Our highly trained application engineers are available to provide technical assistance and can help in developing source control drawings (SCD) which define the proper PMO (post manufacturing operations) needed to achieve optimum component reliability, stability and performance. Examples for PMO tests include: short time overload, power conditioning, thermal shock, thermal conditioning, etc.

### MANUFACTURE

Vishay Foil Resistors are manufactured in a modern plants complex under exacting conditions of cleanliness. White rooms are used in several stages of production. The entire process is under close quality control surveillance.

Batch handling, similar to the process used in semiconductor manufacture, ensures uniform quality. Each resistor element is inspected and processed under high magnification microscopes.

All materials used in the resistor and in the manufacturing process are carefully controlled and inspected, with permanent records maintained. All units are tested electrically, mechanically and visually for conformance to specifications.

The resistors are delivered in ESD approved packaging.

**TABLE 1 - DSCC, EEE-INST-002, AND EPPL**

(In accordance with: MIL-PRF-55432, MIL-PRF-55182, MIL-PRF-49465)

TYPE	CONSTRUCTION	DSCC (1)	EEE-INST-002 (2)	EPPL (3)	TYPICAL TCR MIL RANGE (ppm/°C)	LOAD LIFE STABILITY 2000 h
VSMP0805	Wrap around terminations	07024	√	√	0.2	0.005 %
VSMP1206		07025	√	√		
VSMP1506		03010	√			
VSMP2010		06001	√	√		
VSMP2512		06002	√	√		
VSM0805		07024	√		2	
VSM1206		07025	√			
VSM1506		03010	√			
VSM2010		06001	√			
VSM2512		06002	√			
SMR1DZ	Flexible terminations With robust construction	06020	√		0.2	
SMR1D		06020	√		2	
SMR3DZ		06021	√		0.2	
SMR3D		06021	√		2	
VCS1625Z	Current sense with Kelvin connections for a high accuracy	08003	√		0.2	
VCS1625		08003	√	√	2	
VCS1610		TBD	√			
CSM2512		07011	√		15 maximum	0.05 %
CSM3637		07012	√			
VSMP0603 (New)	Wrap around terminations	TBD	√		0.2	0.005 %

**Notes**

1. DSCC (Defense Supply Center Columbus)
  2. EEE-INST-002 (Instruction for EEE Parts Selection, Screening, Qualification, and Derating)
  3. EPPL (European Preferred Parts List)
- All the above resistors are also available on the shelf as standard products

# Selector Guide

Military and Space Applications



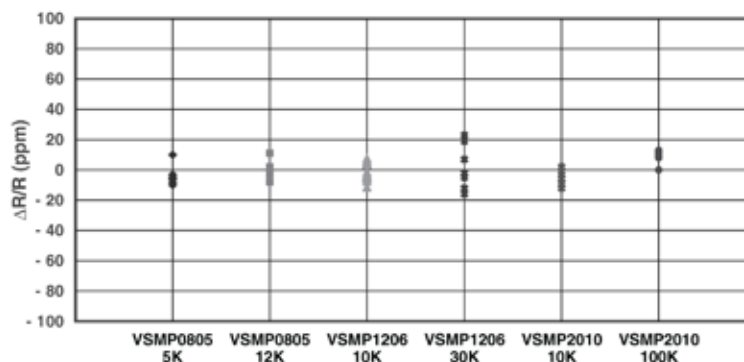
**TABLE 3 - CSM2512 EEE-INST-002 QCI PER AER #155518 AND MIL-PRF-49465C F.C. #294499, VALUE 0R01**

GROUP	TESTS	CONDITIONS	AVERAGE $\Delta R$ (ppm)	MAXIMUM $\Delta R$ (ppm)	MINIMUM $\Delta R$ (ppm)	REJ./ACC.
I	Resistance to solvent	MIL-STD-202G, method 215	V	V	V	0/4
II	TS	5 x (- 65 °C to + 125 °C)	43	120	- 40	0/10
	TCR	at - 55 °C to + 25 °C	- 0.08	3.36	- 3.13	0/10
	TCR	at + 25 °C to + 125 °C	- 4.86	- 1.69	- 7.70	0/10
	LTS	24 h at - 55 °C	9	20	0	0/10
	Overload	at 5 x P <sub>nom</sub> , 5 s	29	60	- 20	0/10
	Moisture resistance	10 days	42	70	10	0/10
III	Load life:					
	250 h	at 1 W at + 70 °C	129	230	30	0/20
	500 h		177	290	50	0/20
	1000 h		271	420	130	0/20
	2000 h		326	520	150	0/20
IV	TS	5 x (- 65 °C to + 125 °C)	16	40	- 20	0/30
	Shock	100 G, 6 ms	0	20	- 30	0/30
	Vibration	(10 to 2000 Hz) 20 G	- 8	20	- 40	0/30
V	HTE					
	250 h	1000 h at + 170 °C	774	1510	300	0/30
	1000 h		1375	2350	780	0/30

**Note**

- Measurement error RC = 0.0005R - should be added to limits

**FIGURE 2 - VSMP 100 CYCLE THERMAL SHOCK - 65 °C TO + 150 °C, 10 UNITS EACH VALUE**





## Resistor Sensitivity to Electrostatic Discharge (ESD)

### Introduction

For most of us, electrostatic discharge (ESD) and static electricity are little more than the shock received when touching a metal doorknob after walking along a carpeted floor, or when opening a car door. The level of the voltage produced depends on a number of factors, such as the affinity of the two bodies and the air humidity, and can reach over 25 000 V. We experience these occurrences of static electricity everyday.

ESD can be defined as a rapid transfer of charge between bodies at different electrical potentials – either by direct contact, arcing, or induction – in an attempt to become electrically neutral. The human threshold for feeling an ESD is 3000 V, so any discharge that can be felt is above this voltage level.

While an ESD does not actually harm the human body, it is possible for electronic devices to be damaged by it, even by a discharge that is under 3000 V. ESD damage can occur at any stage of the part's life, from manufacturing to service. Damage can be caused from handling ESD-sensitive (ESDS) devices without taking precise precautions to eliminate any potential discharges onto them. The most common cause of ESD damage is direct transfer of an electric charge from either a human body or a charged material to an ESDS device.

In resistors, ESD sensitivity is a function of their size. The smaller the resistor, the less space there is to spread the energy pulsed through it from the ESD. This energy concentration in a small area of a resistor's active element causes it to heat up, which could lead to irreversible damage. With the growing trend of miniaturization, electronic devices, including resistors, are becoming smaller and smaller, causing them to be more prone to ESD damage.

ESD damage is generally divided into three categories:

- **Parametric Failure** – The ESD event alters one or more of the device parameters (resistance in the case of resistors), causing it to shift from its required tolerance. This failure does not directly pertain to functionality; thus a parametric failure may be present even if the device is still functional. For example, if a 10 k $\Omega$  resistor with a 1 % tolerance undergoes an ESD event that changes its resistance to 11 k $\Omega$  (10 % deviation), the device would still be able to function as a resistor; however, its altered parameters would no longer be suitable for its original function.

- **Catastrophic Damage** – The ESD event causes the device to immediately stop functioning. This may occur after one or a number of ESD events, and may have many causes, such as human body discharge or the mere presence of an electrostatic field.
- **Latent Damage** – The ESD event causes moderate damage to the device, which is not noticeable, as the device appears to be functioning correctly. However, the load life of the device is dramatically reduced, as further degradation caused by operating stresses may cause the device to fail during service. This defect is of greatest concern as it is very difficult to detect by visual inspection or re-measurement.

Different resistor technologies exhibit various levels of sensitivity to ESD damage. Damage to an ESDS device depends on the device's ability to dissipate energy and withstand the energy of the voltage levels involved, and is generally exhibited by a change in the electrical resistance of the device. This is especially crucial in devices requiring high precision and reliability.

Thin film resistors are composed of a metal layer that is only a few hundred angstroms thick. This severely limits the device's capability to withstand the energy that is passed through it during an electrostatic discharge, causing it to be very sensitive to ESD damage. Thin film resistors are energy dependent and can experience value changes of up to 5 % before the ESD causes the film to rupture (Figure 2).

Thick film resistors are so sensitive to ESD voltages that the application of ESD is sometimes used as a trimming method, as these resistors almost always experience negative resistance changes when exposed to ESD. Applying an ESD can thus have the positive effect of reducing overshooting of the desired resistance. However, this is only useful in the calibration stage of production, and any additional exposure to ESD after calibration can cause a resistance change of over 50 %, which would obviously be a large deviation from the desired resistance tolerance.

Foil-based resistors have a number of characteristics that make them superior to both thin and thick film when it comes to withstanding ESD. For one thing, foil is 100 times thicker than thin film, and therefore the heat capacity of the resistive foil layer is much higher compared to the thin film layer.

## Resistor Sensitivity to Electrostatic Discharge (ESD)

### ESD test on Surface Mount Chip Resistors

By using a 500 pF capacitor charged up to 4500 V, pulses were performed on a number of 10 kΩ resistors (metric size RR3216M, inch size RR1206), with an initial voltage spike of 2500 V (Figure 1). The unit was allowed time to cool down, after which the resistance measurement was taken and displayed in ppm deviation from the initial reading. Readings were then taken in 500 V increments up to 4500 V.

Figures 2, 3, and 4 show the resistance shift after increasing ESD voltage pulses. The foil chips (Figure 4) show no measurable shift.

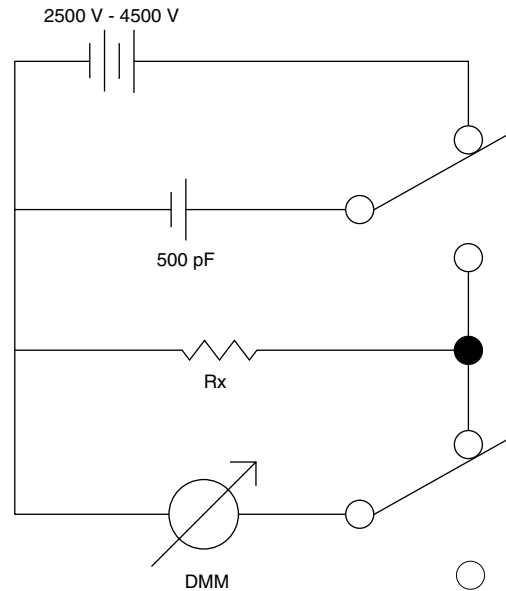


Figure 1.

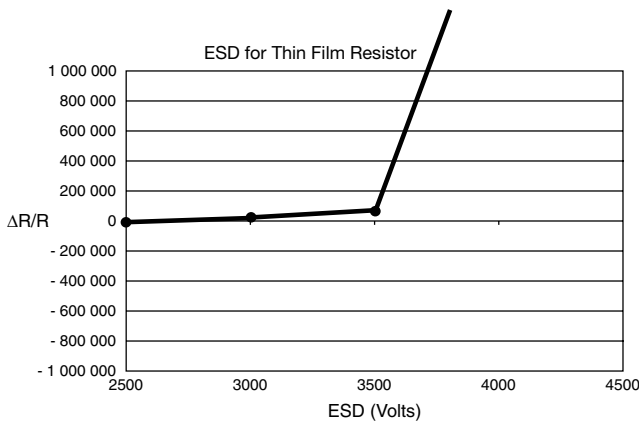


Figure 2.

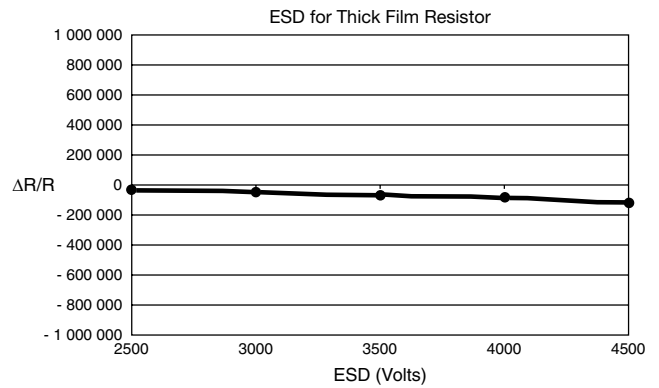


Figure 3.

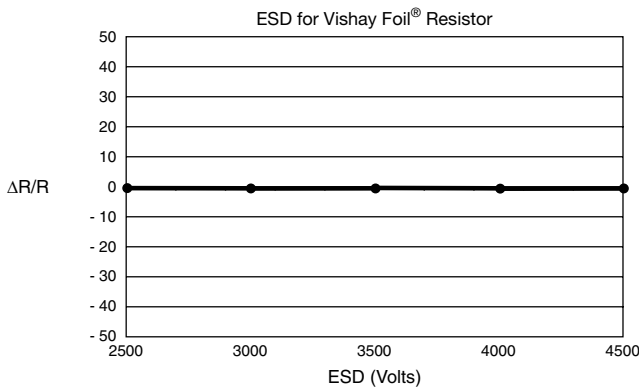


Figure 4.

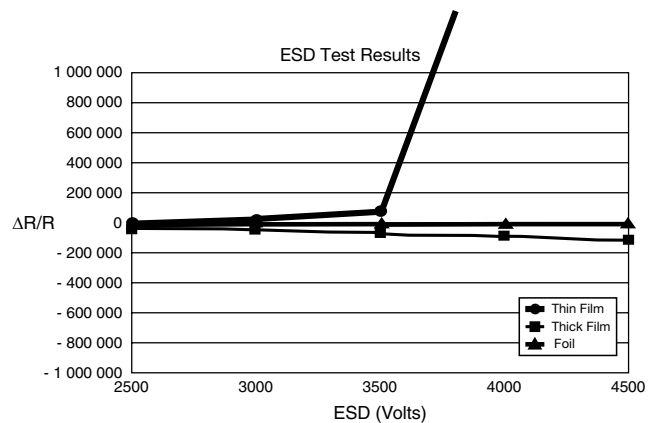


Figure 5.



### Conclusions

The superiority of Bulk Metal<sup>®</sup> foil precision resistors over thin film, when subjected to ESD, is attributed mainly to their greater thickness (foil is 100 times thicker than thin film), and therefore the heat capacity of the resistive foil layer is much higher compared to the thin film layer. Thin film is created through particle deposition processes (evaporation or sputtering), while foil is a bulk alloy with a crystalline structure created through hot and cold rolling of the melt.

Tests performed have indicated that foil chip resistors can withstand ESD events above 25 000 V (data available), while thin film chip resistors have been seen to undergo catastrophic failures at electric potentials as low as 3000 V (parametric failures at even less). If the application is likely to confront the resistor with ESD pulses of significant magnitude, the best resistor choice is Foil.

The Current Path in a Thin Film Resistor  
Particle-to-Particle Matrix

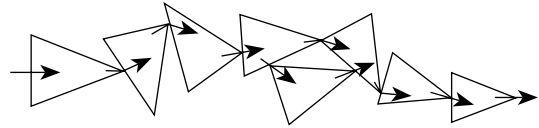


Figure 6.

The Current Path in a Bulk Metal<sup>®</sup> Foil Resistive Alloy

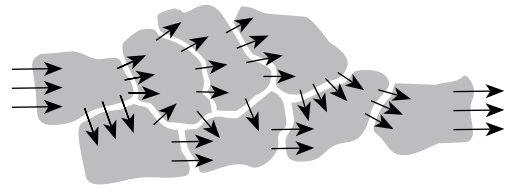


Figure 7.

## The Effects of Short-Time Overload on Resistive Elements in Vishay Bulk Metal® Foil and Thin Film Precision Resistors

### Introduction

When designing any type of analog circuit, all possible causes of circuit failure need to be taken into consideration, as do the consequences of these failures. Such considerations are particularly important when the long-term reliability, stability, and precision of the circuit are vital to the application.

One source of failure that circuits are exposed to in most applications is temporary overloads of unexpectedly high current, or short-time overloads (STO). A component that is subjected to an STO will be required to dissipate more power than usual, causing extreme heat that can lead to extensive component damage, and even catastrophic failure. However, designs that integrate overload protection can help prevent serious damage or component failure.

### Bulk Metal Foil vs. Thin Film Resistors

Vishay's Bulk Metal® foil technology inherently has superior overload and pulse handling capabilities compared to other resistor technologies, such as thin film. By nature, foil resistors can withstand prolonged periods of extreme overload conditions, without failure and without sustaining any serious internal or external damage.

The Vishay foil resistive element consists of a thick, flat layer of conductive metal alloy, bonded to an inert alumina substrate, and photo etched into a series of resistance paths. This allows scribe trimming to be performed. The resistor's design achieves almost zero inductance, allowing rapid rise times and excellent high-frequency performance.

Many of the advantages of Vishay's foil resistors over thin film resistors are derived from the thickness of the resistive element, which is 100 times greater than that of thin film. This thickness provides a high heat capacity, which results in the low temperature rise of the resistive element under a short pulse. Thin film resistors, however, lack the pure mass, and therefore the heat capacity, to handle the heat generated in a short pulse, and will typically burn up and fail.

Even under harsh environmental conditions, a Bulk Metal precision resistor rated at a 0.01 % purchased tolerance can retain most of this accuracy throughout its life, with only small predictable changes. Other precision resistors suffer

much less predictable drift, and their specifications may eventually drift by as much as several orders of magnitude.

Vishay foil resistors are made to six-digit accuracy, providing 10 times lower thermal EMF than other resistor technologies, as well as better temperature stability, tighter load life stability, and enhanced reliability.

Though normally housed in moisture-resistant molded packages, the Vishay line of foil resistors also includes surface-mount and hermetic packages for ultra stability.

### Short-Time Overload Test

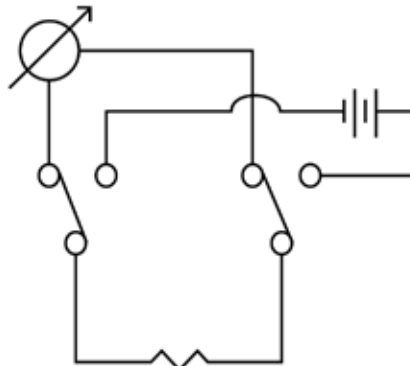
Vishay has performed a test that demonstrates the limited effect of STO on foil resistors when compared to competing technologies.

The tested resistor (Rx) is connected to a precision digital multi-meter (DMM), which takes the initial resistance reading (see Figure 1). After the reading is taken, the resistor is switched over to a power supply that applies an overload voltage for five seconds. After a sufficient cool-down time, the subject resistor is then switched back to the DMM, and the resistance is read again. The  $\Delta R/R$  is displayed.

The test measures the change in resistance of the subject resistor due to the applied overload. The screen displays the  $\Delta R/R$ , which is the difference in the resistance readings taken before and after the overload.

Mil-PRF-55342 defines the STO test as 2.5 times the rated continuous working voltage, but not exceeding twice the maximum voltage, applied for five seconds. The resistors are then examined for evidence of arcing, burning, and charring.

This demonstration measures the  $\Delta R/R$  (measured in ppm) of a 100R resistor subjected to an overload of 7 W for five seconds. This overload exceeds the power ratings of each device under test, specifically by a factor of nine for the Vishay VSMP2512 resistor, and a factor of seven for the thin film resistor.



**Rx**  
**100R**  
Figure 1.

```

POWER OVERLOAD TEST PARAMETERS .....

NOMINAL TEST VALUE ..... 100R
APPLIED WATTAGE ..... 7 W
ACTUAL APPLIED VOLTAGE ..... 26.5 VDC
TEST DURATION ..... 5 SEC.

PLACE TEST RESISTOR IN FIXTURE AND PRESS <T> TO TEST... <Q> TO QUIT PROGRAM

STAND BY ... TEST IN PROGRESS

** SYSTEM ZEROED **
READY FOR POWER SHOT

POWER SHOT ON !!! ** 26.5 VDC FOR 5 SECONDS **
** COOL DOWN CYCLE *** 5 SECONDS **

DELTA R (RC2-RC1).....11 PPM

ENTER <R> TO RESTART ..... <Q> TO QUIT PROGRAM .....
    
```

STO for Foil Resistor

```

POWER OVERLOAD TEST PARAMETERS .....

NOMINAL TEST VALUE ..... 100R
APPLIED WATTAGE ..... 7 W
ACTUAL APPLIED VOLTAGE ..... 26.5 VDC
TEST DURATION ..... 5 SEC.

PLACE TEST RESISTOR IN FIXTURE AND PRESS <T> TO TEST... <Q> TO QUIT PROGRAM

STAND BY ... TEST IN PROGRESS

** SYSTEM ZEROED **
READY FOR POWER SHOT

POWER SHOT ON !!! ** 26.5 VDC FOR 5 SECONDS **
** COOL DOWN CYCLE *** 5 SECONDS **

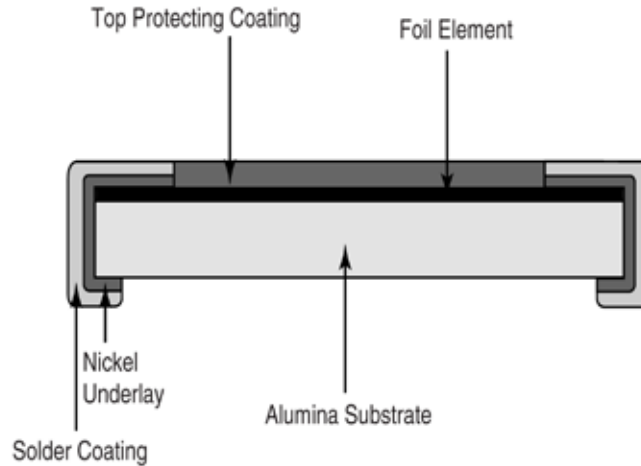
DELTA R (RC2-RC1).....294221 PPM

ENTER <R> TO RESTART ..... <Q> TO QUIT PROGRAM .....
    
```

STO for Thin Film Resistor

## The Effects of Short-Time Overload on Resistive Elements

The foil resistors exhibit excellent stability and virtually no drift following the power spikes, demonstrating that the Bulk Metal® foil VSMP2512 chip resistor is capable of handling high power spikes well beyond common test limits.



Drawing not to scale

Figure 2. Surface Mount Wrap-Around Chip Foil Resistor Construction

	VISHAY FOIL RESISTOR	THIN FILM RESISTOR SIZE 2512
Type	VSMP2512	Thin Film Chip
Value	100 Ω	100 Ω
TCR	0.2 ppm/°C (MIL-RANGE)	25 ppm/°C (MIL-RANGE)
Rated Power	750 mW	1000 mW
ΔR under surge	< 100 ppm	open

The following graph illustrates typical foil resistor behavior after undergoing short-time overloads of 6.25 times rated power for five seconds:

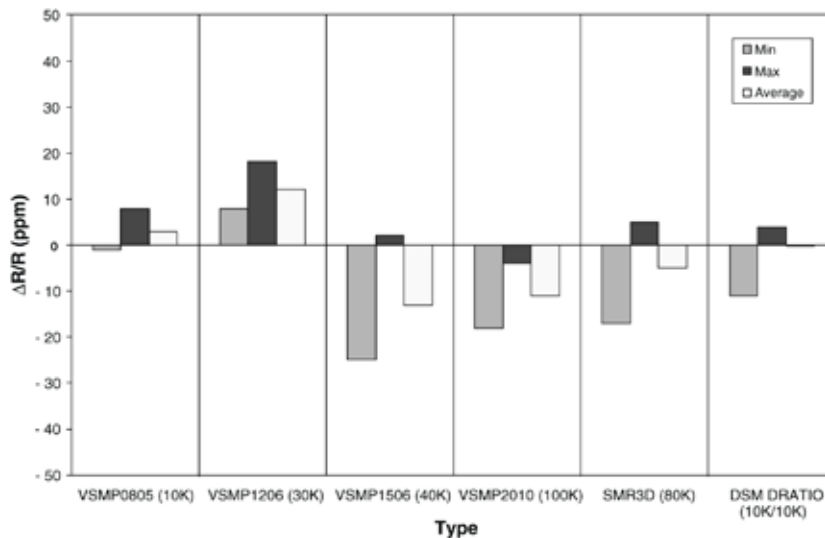


Figure 3. Resistance Deviation after Short Time Overload of x 6.25 Rated power for 5 seconds  
VSMP - 10 units tested, SMR3D - 80 units tested, DSM - 20 units tested.

## Designing with Foil Resistors in Hermetic Packages (The ultimate in resistor network performance)

When relative performance along with absolute performance is a resistance requirement, the preferred solution is a network of resistors. The combining of resistors in a common package reduces the temperature variation by sharing the heat during non-uniform loading. Table 1 shows the expected performance from resistor networks made in various ways, including thick film, thin film, and Bulk Metal® foil. The following discussion elaborates on the expected performance improvements when moving up the technology ladder to the foil network in a hermetic enclosure.

**TABLE 1 - NETWORK PERFORMANCE**

NETWORK TECHNOLOGY	THICK FILM	THIN FILM	HERMETIC FOIL
Absolute tolerance	1 %	0.10 %	0.005 %
Ratio tolerance available	1 %	0.10 %	0.005 %
Temperature coefficient	300 ppm/°C	25 ppm/°C	5 ppm/°C
TCR tracking	100 ppm/°C	10 ppm/°C	0.5 ppm/°C
Tracking change with load life	500 ppm	250 ppm	20 ppm
Δratio with moisture	1000 ppm	5000 ppm	10 ppm
Rise time	50 ns	10 ns	1 ns without ringing
Resistance to soldering heat	0.25 % - 3 %	0.10 %	0.01 %

### The Underlying Technologies

**Foil Resistors** are made by rolling a nickel/chromium alloy down to a 100 μin thickness and bonding it to a ceramic substrate. A selection of masks permits value determination followed by binning and subsequent calibration. There are normally no NRE charges because the parts are individually drawn from an established inventory of chips. Further improvement is possible by having two or more values sharing the same substrate and by applying post-manufacturing operations.

**Thin Film Resistors** are made by depositing a resistive alloy onto a ceramic surface. The deposition layer is about 250 Å thick and requires careful masking to create the network image for subsequent calibration. This masking is also subject to an NRE charge for any values which are not part of the standard production line, and can result in long lead times.

**Thick Film Resistors** are made by screening a layer of resistive glaze onto a ceramic substrate and firing at a temperature above the melting point of the glass frit. Resistance range is controlled by the amount of metal in the glaze and subsequent calibration. A network can be made this way by silk screening the ink (or glaze) in a defined pattern. The cost of the screen preparation is subject to (NRE) charges.



## Designing with Foil Resistors in Hermetic Packages

Vishay hermetic resistor networks are based on fabrication from a standing inventory of packages and resistor chips. This permits quick delivery of prototypes since there are no masks to design or trial processings to be made. Further, it allows any combination of values, tolerances and circuits. There are normally no engineering or setup charges, and no minimum quantities are required. Delivery can be in two weeks from Vishay's Network Express Prototype Service.

The sequence of fabrication includes selection of chips, die attachment, wirebonding, value trimming, dry nitrogen back-fill, and hermetic sealing. The finished product provides the stability associated with Bulk Metal foil resistors in a hermetically sealed package. Vishay offers a variety of packaging options, as outlined in Table 2 below.

### The Available Packages

<b>TABLE 2 - PACKAGES</b>	
<b>DIP, PLUG-IN, LEADLESS CARRIER, AND FLATPACKS</b>	
<b>Ceramic package:</b>	94 % alumina (AL <sub>2</sub> O <sub>3</sub> )
<b>Lid:</b>	Gold plated Kovar
<b>Attachment:</b>	Solder - tin/gold eutetic
<b>Leads:</b>	Alloy 42 (iron nickel) with 100 μ" gold plating, MIL-STD-1276, type G-21-A
<b>TO packages:</b>	
<b>Metal cover:</b>	Grade A nickel
<b>Header:</b>	Gold plated Kovar
<b>Attachment:</b>	Welded
<b>Leads:</b>	Kovar with 100 μ" gold plating, MIL-STD-1276, type K-21-A
<b>HERMETICITY</b>	
<b>Gross leak:</b>	No bubbles, MIL-STD-202, method 112, test condition D
<b>Fine leak:</b>	< 5 x 10 <sup>-7</sup> cc/s MIL-STD-202, method 112, test condition C, procedure 111A

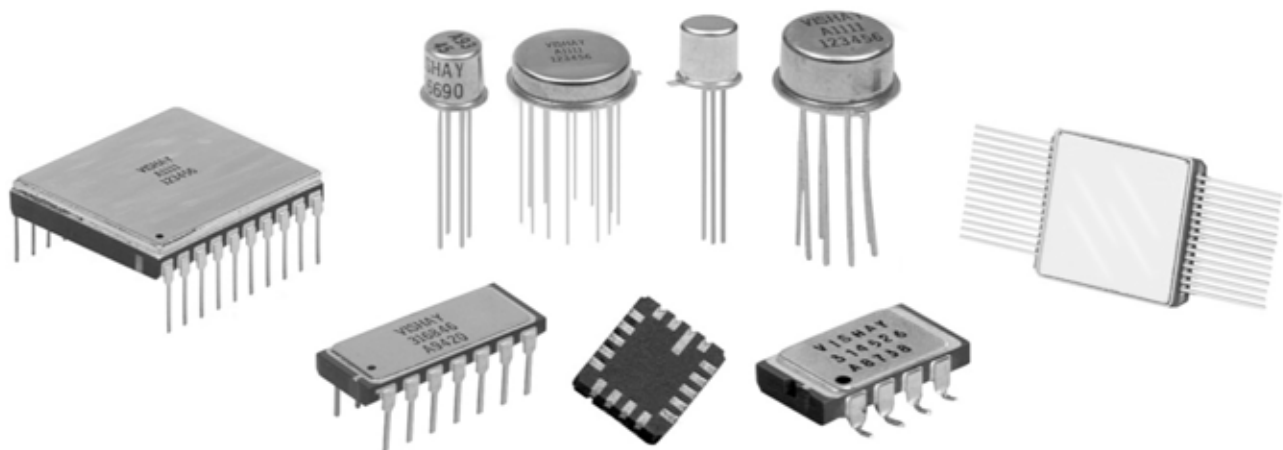


Figure 1. A montage of the packages

### Standard and Custom Packages

- The photo on page 2 shows a broad spectrum of standard network packages available. Selection from one of these standard packages ensures prompt delivery of prototypes.
- Glass-to-metal seal headers offer good thermal dissipation and sharing of temperatures between resistors.
- Ceramic dual-in-line packages offer more pin availability and more chip capacity.
- Ceramic flatpacks offer the lowest profile, but take more board space.
- Ceramic leadless carriers are also available. However, when tight tolerances or low values are considerations, fixturing and associated contact resistance must be taken into account.
- Vishay can develop custom packages for specific applications. Contact our Applications Engineering Department for assistance.

### Qualified Producers List

Vishay Models 1445Q and 1446Q networks are qualified to MIL-PRF-83401, Characteristic C, Schematic A. Actual performance exceeds all the requirements of MIL-PRF-83401 characteristics "C".

Model 1445Q contains 7 resistors and 1446Q contains 8 resistors. Qualified resistance range is 100  $\Omega$  through 10 k $\Omega$ . Other values are available non-QPL. Power rating is 0.1 W per resistor.

### Available Circuits

The enclosure method employed by Vishay for DIP, LCC and Flatpack packages utilizes a ceramic package and a gold plated Kovar lid tin/gold solder-sealed to the ceramic. TO packages, have a glass to metal seal header and a metal can or cover is welded to the header. Contact Applications Engineering if special requirements are applicable. See the individual data sheets for package dimensions and chip layout. Table 3 below summarizes the standard packages available.

Hermetic sealing of Vishay's networks enhances their already inherently stable environmental performance. The result is improved load life stability and better performance during high temperature and moisture exposure. Table 1 in "7 Technical Reasons to Specify Bulk Metal Foil Resistor Networks" compares these networks to the requirements of other military types of networks.

**TABLE 3 - PACKAGES AND THEIR POTENTIAL CIRCUITS**

VISHAY MODEL #	GENERIC PACKAGE	NUMBER OF PINS	CHIP V5x5 CAPACITY	CHIP V15x5 CAPACITY	PACKAGE POWER	EXAMPLES OF CIRCUITS
1401	TO18	3	2	1	0.15 W	Divider, center-tap grounded
1403	TO18	4	5	1	0.15 W	Divider, case grounded
1413	TO5	8	9	3	0.4 W	Divider, case isolated
1417	TO5	8	12	3	0.4 W	Three dividers
1419	TO5	10	12	3	0.4 W	Shift-down weighted ladder
1421	TO8	12	49	16	0.6 W	Four dividers
1422	TO8	16	49	15	0.6 W	7-bit ladder
1442 <sup>(1)</sup>	DIP	8	12	4	0.4 W	Four feed-through Rs
1445 <sup>(1)</sup>	DIP	14	30	10	1.2 W	Two decades of BCD ladder
1446 <sup>(1)</sup>	DIP	16	36	12	1.4 W	11-resistor string with taps
1457	DIP	18	80	25	1.8 W	7-bit R2R ladder
1460	DIP	20	221	73	2.4 W	12-bit R2R ladder
VSM85	LCC	16	12	4	0.4 W	Four dividers
VSM86	LCC	20	16	4	0.6 W	Five dividers
VSM87	LCC	24	16	5	0.6 W	Six dividers
VSM88	LCC	28	25	10	1.0 W	Seven dividers
VSM89	LCC	32	35	14	1.4 W	Eight dividers
1476	Flatpack	30	225	75	2.4 W	12-bit R2R ladder

**Note**

<sup>(1)</sup> Available in Gull-Wing Lead-Form package





Network performance is established during the engineering design phase and is dependent on the materials of construction. Most characteristics are inherent in the Bulk Metal foil technology and provide the high order of performance displayed throughout this catalog. Stability and drift levels can be improved beyond those shown in the catalog. Applications Engineering is available to recommend screen testing beyond the standard outgoing inspection when catalog limits are insufficient. The chart below shows the standard outgoing testing and the additional user specified screen tests that may be appropriate for a particular application.

### Testing of Commercial Product - VISHAY Networks

Our standard outgoing testing consists of:

1. DC resistance test 100 %
  - 1.1 Conformity to value
  - 1.2 Conformity to tolerance
2. Visual and mechanical 100 %
  - 2.1 Conformity to physical size
  - 2.2 Cleanliness of leads
  - 2.3 Conformity of printing
3. Hermeticity test 100 %
  - 3.1 Fine leak test
  - 3.2 Gross lead test
4. Shipping inspection (sample plan)
  - 4.1 Conformity of packaging
  - 4.2 Conformity of count

### Additional Testing to MIL Spec

Group A testing to MIL-PRF-83401 imposes the following:

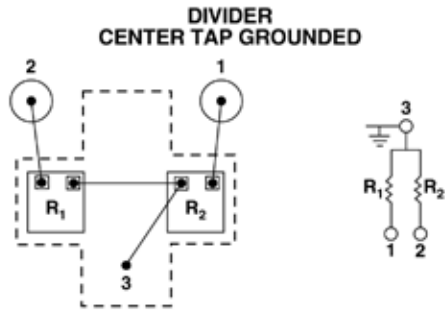
1. Thermal shock 100 %
  - 5X from - 65 to + 125 °C
2. Power conditioning 100 %
  - 2.1 100 h at 25 °C, 1.5 x rated power
  - 2.2  $\Delta R$  and  $\Delta$ ratio calculation
3. Visual and mechanical inspection after the above tests (sample plan)
  - 3.1 Conformity to physical size
  - 3.2 Workmanship
  - 3.3 Damage due to the above tests
4. PDA - 10 % allowed (or one piece, whichever is greater)
5. Solderability (sample plan)

Group B sample testing to MIL-PRF-83401 imposes the following:

1. Temperature coefficient of resistance (sample plan)
2. Resistance to solvents (sample plan)

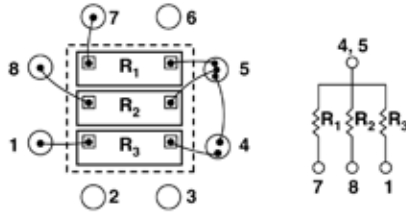
### Circuit and Package Examples

Divider in 1401 package:

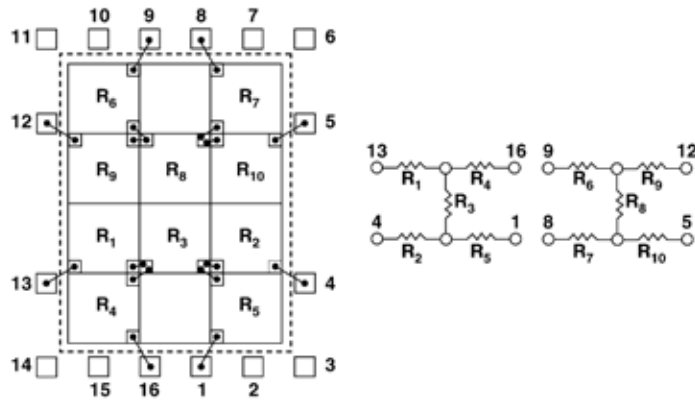


3-resistor array in 1413 package:

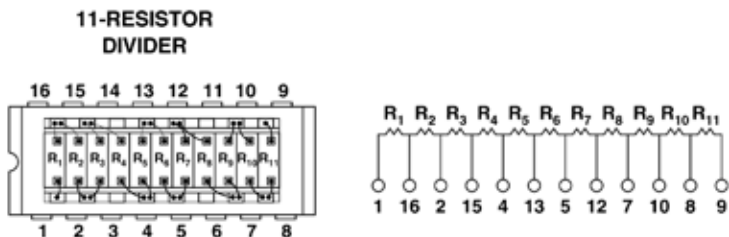
**3-RESISTOR ARRAY, CASE ISOLATED**



4 voltage dividers in VSM86 package:



11-resistor divider in 1446 package:



## Resistance Trimmers

### Introduction

Resistance trimmers are required when the value of resistance or voltage division in a circuit must be adjusted to compensate for environmental influences, when the desired circuit performance cannot be procured and retained through manufacturing, or it is unknown what precision is required. This applies to precision applications, among others, but in this paper, the selection and use of the trimmer focuses on available performance.

### Description

Trimmers are mechanically driven, variable resistors. A wiper is moved across the resistance element, picking off an intermediate voltage in the potentiometer mode, or adding resistance in the rheostat mode. Some models employ a lead screw, while others drive a gear. All models have a clutch at either end of travel to avoid mechanical damage. These mechanical aspects have caused some users to avoid designing with trimmers and are of special concern when selecting trimmers for precision applications. This paper will describe the various types of trimmers available, and how the selection of foil-based trimmers compensates for the deficiencies of other types.

### Selection

Trimmers are made with elements comprised of different materials, each with its own set of characteristics.

**Wirewound** - Trimmers made of wirewound elements are the original trimmers. They have a relatively good end-to-end temperature coefficient of resistance, but are limited in resistance range and display a step function output that is particularly objectionable in the lower values.

**Cermet** - Trimmers made of screened and fired inks extend the range of values over wirewounds, and have introduced the claim of infinite resolution. However, users have learned that the curve trace is not a smooth and unidirectional change of resistance, and the end-to-end TCR is 100 to 300 ppm/°C.

**Other** - Several other elements have been tried, but each has its own disadvantages. For example, thin film provides a relatively good TCR, but poor rotational life. Carbon impregnated plastic provides a good rotational life, but high TCR and poor tolerance.

In all the above cases, the TCR through the wiper is not specified (yet extremely important) because it is very high and inconsistent.

**Bulk Metal® Foil** - With the foil technology, there is a smooth and unidirectional, infinite resolution adjustment for lower ohmic values, and somewhat lesser resolution for values 5 kΩ and above. The foil also achieves a very low TCR end-to-end, and the TCR though the wiper can be specified (and is also relatively low). Further, the contact resistance variation is now reduced through the use of a multi-fingered wiper on a planer surface. Finally, the unique element resistive pattern design minimizes the capacitive and inductive reactance levels. All in all, this has become the trimmer of choice for precise adjustment.

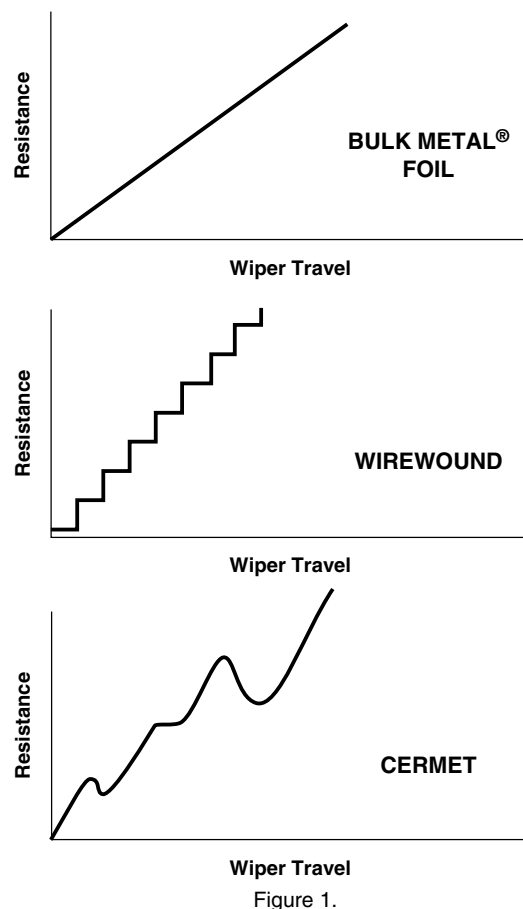


Figure 1.

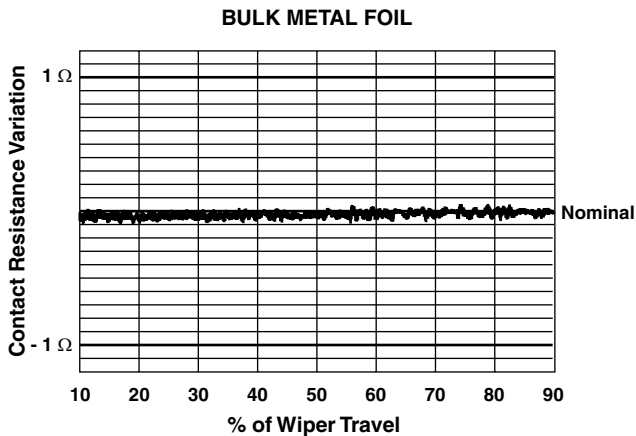


Figure 3.

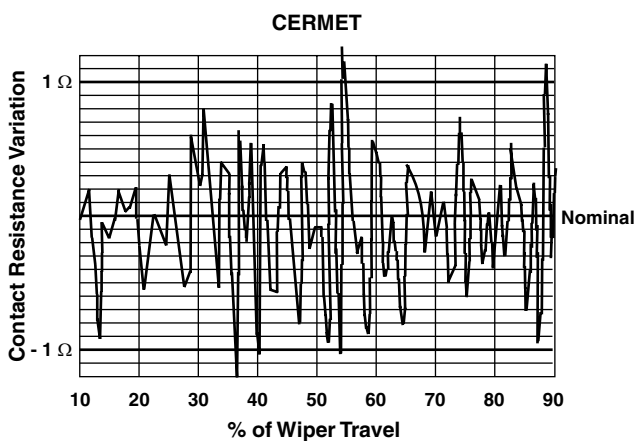


Figure 4.

### Low Reactance - No Signal Retardation From Inductance or Capacitance

Like all foil-based resistance elements, the resistive pattern is flat and etched into the foil to produce different values of resistance end-to-end. This affords the opportunity to lay the pattern out in opposing transverse directions, so that the inductance from one line is opposed by the adjacent line (unlike a wirewound element that has current in adjacent turns, creating a field of mutual inductance). Also, the current paths represent capacitors in series, so the lumped capacitance is very low.

### Moisture Sealed

All trimmers are hollow and subject to pressure increases when heated and pressure decreases when cooled. As a

consequence, the hot liquids in which the board is washed may be drawn into the product when the board is removed into cooler air. Vishay foil based trimmers are equipped with an O-ring that retards this ingress and egress of contaminants, making them safe for board washing.

### Summary of Attributes

Collectively, the foil-based trimmer is superior to any other type, and Table 1 shows the comparison in each model range.

### Value Range - Lower Values are Preferred

Some users are accustomed to improving the output linearity by paralleling the trimmer with another resistor (Figure 5). The cost of the two additional resistors (or one additional depending on the case) by themselves are not much, but the installation cost and the loss of board space can be a factor. Taking advantage of the foil technology, a low-valued foil trimmer in series with a higher-valued fixed resistor (preferably a foil resistor) is the best tradeoff of cost to performance (Figure 6). Viewed this way, the selection of a high-valued cermet trimmer can be a source of noise, instability, and high TCR changes. The cost advantage is not worth the performance risk in most precision applications.

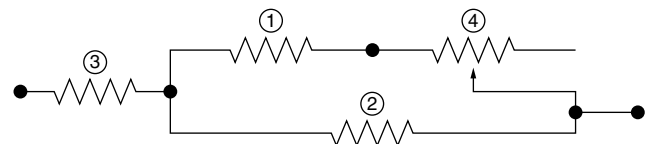


Figure 5. - Conventional Circuit

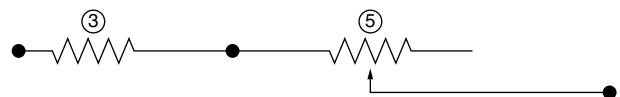


Figure 6. - Circuit with VISHAY Bulk Metal Foil Trimmer

### Conclusions

1. Foil trimmers are preferred for precise adjustment.
2. Foil trimmers are preferred when the adjustment must be stable with mechanical vibration and temperature excursion.
3. Foil trimmers introduce the least noise.
4. An O-ring seal is the surest protection against contaminants.



**TABLE 1 - SPEC COMPARISON OF VISHAY BULK METAL FOIL TRIMMERS TO COMPETITIONORS**

CHARACTERISTIC	VISHAY 1202	ALTERNATIVE INDUSTRY WIREWOUND TRIMMER	ALTERNATIVE INDUSTRY CERMET TRIMMER	VISHAY 1240	ALTERNATIVE INDUSTRY WIREWOUND TRIMMER	ALTERNATIVE INDUSTRY CERMET TRIMMER
Size	1 1/4"			1/4" Square		
MIL style	RJ12	RT12	RJ12	RJ26	RT26	RJ26
Element	foil	wirewound	cermet	foil	wirewound	cermet
Resistance range	2 Ω to 20 kΩ	10 Ω to 50 kΩ	10 Ω to 2 MΩ	5 Ω to 10 kΩ	10 Ω to 25 kΩ	10 Ω to 1 MΩ
TCR end to end	10 ppm	50 ppm	100 ppm	20 ppm	70 ppm	100 ppm
TCR through the wiper	25 ppm	not specified	not specified	50 ppm	not specified	not specified
Setability, 10K value	0.05 %	0.34 %	0.05 %	0.05 %	0.29 %	0.05 %
Contact resistance variation, 10K value	3 Ω	100 Ω	100 Ω	3 Ω	100 Ω	300 Ω
Load life stability	0.001	0.02	0.03	0.005	0.02	0.03
Linearity	infinite	steps	dither	infinite	steps	dither
Power rating	0.5 W	1.0 W	1.0 W	0.25 W	0.25 W	0.25 W
Adjustment turns	25	22	22	21	11	12
"O" Ring sealed <sup>1)</sup>	Yes	No	No	Yes	No	No

CHARACTERISTIC	VISHAY 1260	ALTERNATIVE INDUSTRY WIREWOUND TRIMMER	ALTERNATIVE INDUSTRY CERMET TRIMMER	VISHAY 1280G	ALTERNATIVE INDUSTRY WIREWOUND TRIMMER	ALTERNATIVE INDUSTRY CERMET TRIMMER
Size	3/8" Square			3/4"		
MIL style	RJ24	RT24	RJ24			
Element	foil	wirewound	cermet	foil	wirewound	cermet
Resistance range	5 Ω to 10 kΩ	10 Ω to 50 kΩ	10 Ω to 2 MΩ	10 Ω to 20 kΩ	10 Ω to 50 kΩ	10 Ω to 2 MΩ
TCR end to end	10 ppm	50 ppm	100 ppm	15 ppm	50 ppm	100 ppm
TCR through the wiper	25 ppm	not specified	not specified	50 ppm	not specified	not specified
Setability, 10K value	0.05 %	0.17 %	0.05 %	0.05 %	0.30 %	0.05 %
Contact resistance variation, 10K value	3 Ω	100 Ω	100 Ω	3 Ω	100 Ω	100 Ω
Load life stability	0.001	0.02	0.03	0.005	0.03	0.04
Linearity	infinite	steps	dither	infinite	steps	dither
Power rating	0.25 W	1.0 W	0.5 W	0.75 W	1.0 W	0.75 W
Adjustment turns	21	25	25	26	20	15
"O" Ring sealed <sup>1)</sup>	Yes	No	No	No	No	No

**Notes**

- Potentiometers are hollow and an "O" ring prevents the ingress of fluids during any board cleaning operation
- Foil's multifingered wiper has a very high natural frequency allowing the pot to retain its setting under vibration much better than other devices



## Ultra-High Precision Vishay Bulk Metal® Foil Resistors in Extreme Environments

Over the past few years, there has been considerable growth in the demand for precise, stable, and reliable systems that can operate in harsh environments and at high temperatures.

Many analog circuits for industrial, military, aerospace, medical, down-hole oil exploration, and automotive applications require passive components such as resistors to have a minimal drift from their initial values when operating above + 125 °C and in humid environments.

Vishay's ultra-high-precision Bulk Metal® foil technology includes many types of resistors with a variety of standard configurations that can withstand unconventional environmental conditions above and below the surface.

The high-performance capabilities of Bulk Metal foil resistors are due to the Bulk Metal foil alloy and ceramic substrate combination, which results in a resistor with characteristics unrivaled by any other resistor technology.

Compared to foil, thin film resistor elements are not a controllable material. Heat or mechanical stresses on the thin film element cause the particles forming the film to expand. However, after these stresses are alleviated, the particles in the film matrix do not return to the exact same original position.

A variety of foil resistor configurations and chip packages from the 0805 size and up are used to provide an array of power ratings, sizes, resistance values, and other operating specifications to meet stability and reliability needs in extreme applications.

The stability of a resistor depends primarily on its temperature, which is affected by:

1. Changes in the ambient temperature and heat from adjacent components (defined by the Temperature Coefficient of Resistance, or TCR).
2. Self-heating as a result of load (defined by the power coefficient of resistance, or PCR; which is  $\Delta R$  due to self-heating).

In very high-precision resistors, the difference between the two effects must be taken into account to achieve high stability with changes in load (Joule Effect) and ambient temperature. The foil resistor balances the coefficient of thermal expansion of the Bulk Metal alloy and the substrate, providing great stability and low TCR with significant variations in temperature. Vishay's Z-foil technology

provides a tremendous reduction in the foil element's sensitivity to temperature changes - both external and internal. This technology provides a TCR of  $\pm 0.05$  ppm/°C typical (0 °C to + 60 °C),  $\pm 0.2$  ppm/°C typical (- 55 °C to + 125 °C, + 25 °C ref.), and a PCR of 5 ppm typical at rated power.

Although standard ratings go to + 125 °C, Vishay's customer experience with down-hole applications indicate operating temperatures of + 200 °C for several hours, with much higher temperature excursions. In high temperature environments, even with the use of high-temperature solder, the solder on the resistor leads could reflow. The unique design of the foil S102C resistor prevents damage to the part due to possible solder reflow. The internal lead connection to the resistor element is at the opposite end of the resistor from where the leads enter the package. Additionally, the lead connection to the resistor is a welded connection, no solder is used. (See Figure 1)

Tests conducted by Vishay show acceptable usage up to temperatures of + 250 °C for a period of 24 h, with minimal resistance drift.

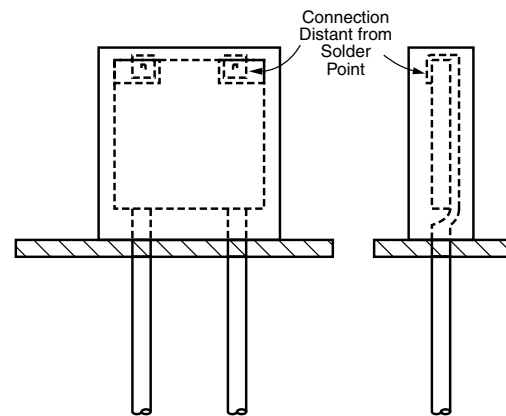


Figure 1.

Electrostatic discharge (ESD) damage to electronic devices can occur at any point in the device's life cycle, from manufacturing to field service. A resistor that is exposed to an ESD event may fail immediately, or may experience a latent defect. In this case, premature failure can occur after the resistor is already functioning in the finished product for a period of time. Vishay's foil resistors are capable of withstanding electrostatic discharges above 25 000 V without degradation.





Foil technology allows us to produce customer-oriented products designed to satisfy unique and specific technical requirements. Our standard production flow includes several 100 % screening tests, such as:

- **Thermal shock:** A major temperature change with a specified temperature gradient is imposed on the device. The test is applied in order to screen out internal connections and grid (foil) defects.
- **CLT (Component Linearity Test):** An effective in-line test to detect and eliminate potential infant mortality failures. This method is very useful in detecting abnormal foil resistor behaviors as the result of imperfections, such as resistive line continuity breakage (micro cracks or mechanically damaged grid lines), short circuits caused by metal particles adjacent to resistive lines, contact instability, etc. In addition, identifying resistors with a potential of excess parametric changes is possible through CLT.
- **Short-Time Overload:** High power for a short period of time - a load life stability simulation. The results of this test are influenced by temperature, time, and power.

The purposes of these tests are:

1. To detect and remove consequent construction defects.
2. To simulate unexpected stresses that may be applied during service.

The above-mentioned 100 % combined screening ensures the high reliability and unique long-term stability of Bulk Metal foil resistors.

In addition to these tests, we offer additional specially oriented post-manufacturing operations for sensitive applications requiring an even higher degree of reliability and stability.

Our Applications Engineering department is always available to assist in any special requirements you might have. If you are not sure which resistor best suits your needs, please do not hesitate to contact them.

## New Ultra-High-Precision Bulk Metal® Z-Foil Resistors with Zero TCR of $\pm 0.2$ ppm/°C and Low Power Coefficient of $0 \pm 5$ ppm at Rated Power

### INTRODUCTION

There is more to resistor precision than meets the eye. The three basic types of resistors: Bulk Metal® Foil, Thin Film and Thick Film are alike on the surface and may often have similar purchased specifications. However, beneath the surface, all three are made differently. Inherent design and processing will strongly influence electrical performances, so that all three behave differently after mounting. These differences will become apparent and vital as the external and internal temperature changes; also the effects of long-term stability, moisture and other environmental conditions take their additional toll with time. This should be taken into account particularly when the circuit requirements become stricter for Signal-to-Noise ratio (SNR) and pulse response. Thus, some so-called precision resistors turn out to be not quite as precise as you might expect after being used in the circuit. To produce a resistor with high precision and high stability characteristics, it is important to be able to control the influence of temperature and environmental conditions on the device's resistance. In precision resistors which require high stability for a long-term use, it is essential to have a fundamentally low Temperature Coefficient of Resistance (TCR).

In precision resistors with low TCR, the self heating (Joule effect) causes the resistor not to perform strictly to its TCR specifications. This inaccuracy will result in an error at the end in the resistance value under applied power. VISHAY Bulk Metal® Foil division introduced a new concept of Power Coefficient of Resistance (PCR) along with a new Z-Foil technology which leads to reduction of the sensitivity of precision resistor to ambient temperature variations and changes of applied power.

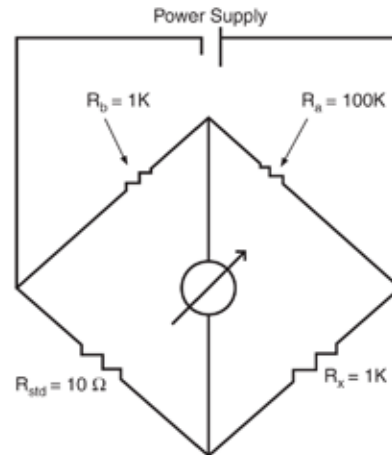
Before selecting an appropriate precision resistor, take a hard look at how the three different types of precision resistors are made and test them to see how these will perform in service.

### EXAMPLE OF POWER COEFFICIENT TEST ON SURFACE MOUNT CHIP RESISTORS

In the test, we used three surface-mount chip resistors of the same size (1206) and same resistance value (1 K). The TCR was measured in each of the resistors (MIL range: - 55 °C to + 125 °C, + 25 °C Ref).

**The VSMP1206 (Foil) chip was randomly selected; and in contrast, we intentionally selected the Thin Film and Thick Film chips with screening to obtain the best TCR.**

During the PCR test, we applied power to the resistors from 100 mW to 500 mW and measured the resistance change during the entire test run.



- $R_a = 100K$
- $R_b = 1K$
- $R_{std} = 10 \Omega$
- $R_x = 1K$

We used a basic Wheatstone Bridge Circuit. The resistance values of the arms of the bridge were selected to place a high wattage on the test resistor ( $R_x$ ), while ensuring a very low wattage on the three remaining legs. When the wattage is increased, any deflection in the circuit is attributed to the self heating of  $R_x$ .

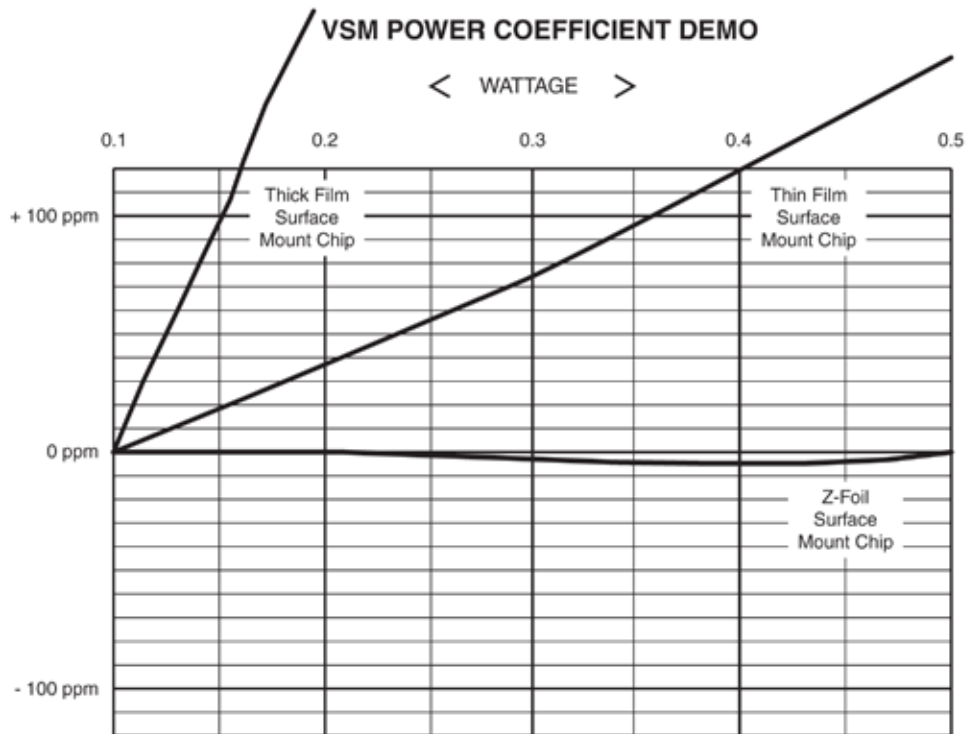
Formula:

$$R_b \cdot R_x = R_{std} \cdot R_a$$

$$1K \cdot 1K = 10 \Omega \cdot 100K$$

RESISTOR TECHNOLOGY	MAXIMUM MEASURED TCR	MAXIMUM PCR at 500 mW
Foil (Z-technology) randomly selected	+ 1.29 ppm/°C	$0 \pm 5$ ppm
Thin Film*	+ 4.18 ppm/°C	> 170 ppm
Thick Film*	+ 31.33 ppm/°C	> 1000 ppm

\* Chips with tight Absolute TCR were deliberately selected.



Y-axis: Resistance change,  $\frac{\Delta R}{R}$  (ppm)

X-axis: Applied power, 100 to 500 (mW)

### CONCLUSIONS

High precision Z-Foil resistors provide the best available stability during changes in resistor temperature due to two factors:

- Change in ambient temperature and heat from surrounding components (TCR)
- Internal heating due to load changes (PCR)

It is necessary to take into account the differences in the resistor behavior for each of the above mentioned temperature factors. Even a small difference in TCR such as 3 ppm/°C (see table on page 1) results in a very high shift of resistance due to applied power.

## Advanced Medical Applications, Treatment Solutions, and Biotechnology

### INTRODUCTION

Bulk Metal<sup>®</sup> foil resistors were invented some 40 years ago by Dr. Felix Zandman. Until today, they remain the performance leader among all resistor types, categories, and brands. Their unique construction, featuring a special resistive alloy, results in a resistor element with characteristics that no other technology can match. These include the industry's lowest temperature coefficient of resistance (TCR), and power coefficient (PCR).

All of these performance characteristics are particularly desirable in medical instrumentation and equipment, where Bulk Metal foil resistors deliver proven reliability and stable performance, even when exposed to unstable levels of temperature and humidity or other harsh environmental conditions. Their long track record of success in medical applications and Vishay's long-term commitment to the medical market have made Bulk Metal Foil the preferred resistor for medical applications including non-invasive equipment, imaging equipment and systems, and biological implants.

As a leading supplier to the worldwide medical market, Vishay has produced a steady stream of breakthroughs in component technology, including new Z-Foil resistors that provide a temperature coefficient of  $\pm 0.2$  ppm/ $^{\circ}$ C and a power coefficient of 5 ppm at rated power: a ten-fold improvement over standard foil resistors.

Many medical applications require custom or semi-custom component solutions. Vishay's Application Engineering department is available to advise customers and to make recommendations regarding non-standard technical requirements and special applications.

Please contact us at [Foil@vishay.com](mailto:Foil@vishay.com).

### KEY FEATURES OF VISHAY BULK METAL FOIL RESISTORS:




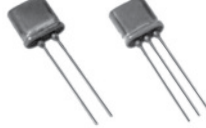



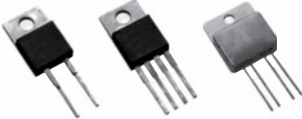
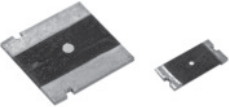
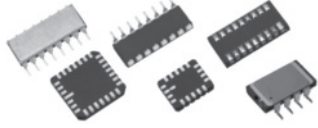

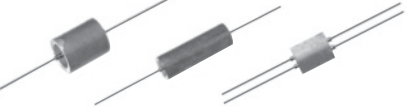
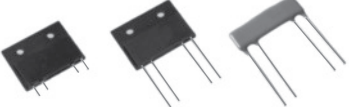
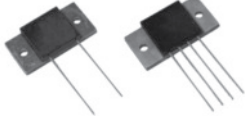
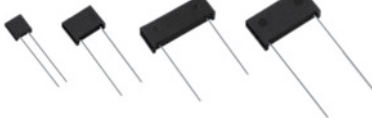

- "Zero TCR":  $\pm 0.2$  ppm/ $^{\circ}$ C (MIL range) with Z-Foil technology
- TCR tracking: to 0.1 ppm/ $^{\circ}$ C
- PCR (power coefficient): 5 ppm typical at rated power for Z-Foil resistors
- Load-life stability under applied power:
  - 0.005 % (50 ppm) over 2000 hours at 70  $^{\circ}$ C
- Resistance range: any value from 2 m $\Omega$  to 3.3 M $\Omega$  (for higher and lower values, please contact us)
- Tolerance: absolute and match for voltage dividers and networks: to  $\pm 0.001$  %
- 4-terminal connections for low values
- Low current noise: - 40 dB
- Thermal EMF: 0.05  $\mu$ V/ $^{\circ}$ C
- Voltage coefficient: < 0.1 ppm/V
- Non-inductive: < 0.08  $\mu$ H
- Rise time: 1 ns without ringing
- Lead (Pb)-free and RoHS compliant available upon request

### THE FOLLOWING DEVICE TYPES ARE AVAILABLE AS PART OF VISHAY FOIL RESISTOR PRODUCT PORTFOLIO:

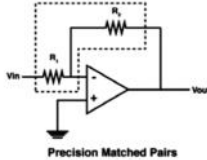
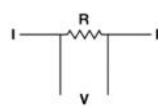
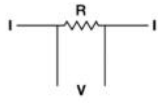
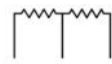

- Surface-mount chips, molded resistors, and networks
- Through-hole (leaded) resistors and networks
- Hermetically sealed and molded networks
- Power current-sensing resistors
- Hybrid chips
- Voltage dividers
- Military-established-reliability resistors
- Trimming potentiometers

### APPLICATIONS:

- Medicine and health care
- Medical R & D projects
- Non-invasive equipment
- Disease detection
- Automated imaging and scanning systems for analysis
- Biological implants
- Biotechnology
- Body navigation solutions (real-time)
- 3D cardiac mapping and navigation
- Electrophysiology

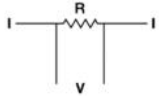
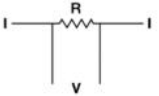
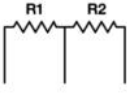
PRODUCTS	
VSMP Series 	SMRxD Series 
VFCE Series 	VH Series 
Z201 	VHP Series 
VC1625Z 	VPR Series 
CSM Series 	PRND 
DSM / SMN 	VHA Series 
VCS Series 	VFP Series 
S Series 	300144 



SURFACE MOUNT			
	SERIES/PART NUMBER	FEATURES	BENEFITS
Wraparound	VSMP Series (Z-Foil) VSM Series (Sizes: 0805, 1206, 1506, 2010, 2512)	<ul style="list-style-type: none"> <li>Nearly zero TCR: "Z-Foil" <math>\pm 0.2</math> ppm/<math>^{\circ}</math>C typical</li> <li>Long-term stability under applied power <math>\pm 0.01</math> % or <math>\pm 0.005</math> % (reduced power) over 2000 hours at <math>+70</math> <math>^{\circ}</math>C</li> <li>Low PCR (power coefficient) 5 ppm typical at rated power for Z-Foil resistors</li> <li>Resistance range: 10 <math>\Omega</math> to 150 k<math>\Omega</math></li> <li>Tolerance: <math>\pm 0.01</math> %</li> <li>Low current noise: - 40 dB</li> </ul>	 <ul style="list-style-type: none"> <li>Precision-matched pairs of Z-Foil VSMP series with absolute TCR of <math>\pm 0.2</math> ppm/<math>^{\circ}</math>C typical and TCR tracking of 0.4 ppm/<math>^{\circ}</math>C typical</li> <li>Protective top coat</li> <li>Excellent stability under different environmental conditions</li> <li>Small size saves circuit board area</li> </ul>
Flip Chip	VFCP Series (Z-Foil) (Sizes: 0805, 1206, 1506, 2010, 2512)		
Molded	SMR1D SMR3D	<ul style="list-style-type: none"> <li>Resistance range: 5 <math>\Omega</math> to 80 k<math>\Omega</math></li> <li>Long-term stability under 0.1 Watt: <math>\pm 0.005</math> % over 2000 hours at <math>+70</math> <math>^{\circ}</math>C</li> <li>Thermal shock: 0.005 % typical</li> <li>Shelf life stability: 25 ppm</li> <li>Moisture resistance: 0.01 %</li> <li>Resistance to soldering heat <math>\pm 0.01</math> % typical</li> </ul>	<ul style="list-style-type: none"> <li>Shielded construction</li> <li>Proven reliability and advanced level of stability</li> <li>Small size</li> <li>Excellent stability under different environmental conditions</li> </ul>
Power Current Sensing	CSM2512 CSM3637	 <ul style="list-style-type: none"> <li>Resistance range: 2 m<math>\Omega</math> to 200 m<math>\Omega</math></li> <li>TCR: <math>0 \pm 15</math> ppm/<math>^{\circ}</math>C</li> <li>Tolerance: <math>\pm 0.1</math> %</li> <li>Rated power: to 3 Watt</li> <li>4-terminal (Kelvin) connections</li> </ul>	<ul style="list-style-type: none"> <li>4-terminal connections reduce terminal resistance effect</li> <li>Small size</li> <li>Tight tolerance</li> </ul>
	VCS1625Z (Foil) VCS1625	 <ul style="list-style-type: none"> <li>Low TCR of <math>\pm 0.2</math> ppm/<math>^{\circ}</math>C (MIL range) typical</li> <li>PCR (power coefficient): 5 ppm/<math>^{\circ}</math>C typical at rated power for Z-Foil resistors</li> <li>Load-life stability under 1 Watt: 0.05 % over 2000 hours at <math>+70</math> <math>^{\circ}</math>C</li> <li>Resistance range: 0.01 <math>\Omega</math> to 10 <math>\Omega</math></li> <li>Tolerance: to <math>\pm 0.1</math> %</li> </ul>	<ul style="list-style-type: none"> <li>High-precision, low-ohmic-value resistors with 4-terminal connections</li> <li>Z-Foil provides a very low TCR and PCR over wide temperature range</li> <li>4-terminal connections reduce terminal resistance effect</li> </ul>
Voltage Dividers & Networks	VFCD1505 (Z-Foil) DSM SMN	<ul style="list-style-type: none"> <li>Any ratio of values between 100 <math>\Omega</math> to 20 k<math>\Omega</math></li> <li>TCR of <math>\pm 0.2</math> ppm/<math>^{\circ}</math>C (MIL range) typical for Z-Foil resistors</li> <li>TCR tracking: 0.1 ppm/<math>^{\circ}</math>C typical</li> <li>Ratio tolerance: 0.01 %</li> <li>Integrated construction - real estate saving</li> </ul>	<ul style="list-style-type: none"> <li>Small size</li> <li>Nearly zero TCR tracking</li> </ul> <p>DSM / VFCD: </p> <p>SMN: </p>
Hermetic Networks (PRND)	VSM40, 42, 45, 46 VSM85-89	<ul style="list-style-type: none"> <li>TCR tracking: 0.5 ppm/<math>^{\circ}</math>C</li> <li>Shelf life stability: 2 ppm typical</li> <li>Load-life stability over 1000 hours: <math>\Delta R = 0.01</math> % <math>\Delta</math>Ratio = 0.005 %</li> <li>Ratio tolerance: 0.005 %</li> <li>Moisture resistance: <math>\Delta R = 0.003</math> % <math>\Delta</math>Ratio = 0.003 % typical</li> <li>No set-up charges</li> </ul>	<ul style="list-style-type: none"> <li>Proven reliability and advanced level of long-term stability</li> <li>Small package for multiple resistors</li> <li>Provides superior environmental protection and moisture resistance</li> </ul>



### THROUGH-HOLE

		SERIES/PART NUMBER	FEATURES	BENEFITS
Molded		Z201 (Z-Foil) S Series S102 IPT (Improved Performance Testing)	<ul style="list-style-type: none"> <li>Nearly zero TCR of <math>\pm 0.2</math> ppm/<math>^{\circ}</math>C (MIL range) typical</li> <li>PCR (power coefficient): 5 ppm typical at rated power</li> <li>Load-life stability under power: 0.005 % after 2000 hours at + 125 <math>^{\circ}</math>C 0.015 % after 10000 hours at + 125 <math>^{\circ}</math>C</li> </ul>	<ul style="list-style-type: none"> <li>Excellent stability and reliability under broad range of environmental conditions</li> <li>Tight tolerance to <math>\pm 0.005</math> %</li> </ul>
Power Current Sensing	Molded	VFP4Z, VCS332Z, VPR221Z, VPR220Z, VCS232Z* (Z-Foil)	<ul style="list-style-type: none"> <li>Resistance range: 0.25 <math>\Omega</math> to 10 k<math>\Omega</math></li> <li>Tolerance: <math>\pm 0.01</math> %</li> <li>TCR: <math>\pm 0.2</math> ppm/<math>^{\circ}</math>C (MIL range) typical</li> <li>PCR: 4 ppm/Watt typical</li> <li>4-terminal connections</li> <li>Power rating: up to 10 Watt on heat sink</li> </ul>	<ul style="list-style-type: none"> <li>High stability and high reliability under harsh environment conditions</li> </ul> 
	Hermetic	VPR247Z, VHP4Z, VHP3Z (Z-Foil)		
	Molded	VFP3, VFP4, VPR220 VPR221, VCS3XX, VCS2XX*	<ul style="list-style-type: none"> <li>Resistance range: 0.25 <math>\Omega</math> to 80 k<math>\Omega</math></li> <li>Tolerance: <math>\pm 0.01</math> %</li> <li>TCR: <math>\pm 2</math> ppm/<math>^{\circ}</math>C (MIL range) typical</li> <li>4-terminal connections</li> <li>Power rating: up to 10 Watt on heat sink</li> </ul>	<ul style="list-style-type: none"> <li>Low ohmic values</li> <li>High power ratings</li> </ul> 
	Hermetic	VPR247, VHP3, VHP4		
Voltage Divider	Molded	300144 300145	<ul style="list-style-type: none"> <li>Any ratio of values between 100 <math>\Omega</math> to 20 k<math>\Omega</math></li> <li>TCR tracking: 0.5 ppm/<math>^{\circ}</math>C</li> <li>Ratio tolerance: 0.005 %</li> <li>Load life stability under 0.05 Watt over 2000 hours at + 25 <math>^{\circ}</math>C <math>\Delta R = 0.002</math> % <math>\Delta</math>Ratio = 0.001 % typical</li> </ul>	<ul style="list-style-type: none"> <li>Nearly zero TCR tracking</li> <li>Provides superior environmental protection and moisture resistance (hermetic packages)</li> </ul> 
	Hermetic	VHD200 VHD144	<ul style="list-style-type: none"> <li>Any ratio of values between 100 <math>\Omega</math> to 20 k<math>\Omega</math></li> <li>Shelf life stability ratio: 2 ppm typical</li> <li>Ratio tolerance: 0.001 %</li> <li>TCR tracking: 0.1 ppm/<math>^{\circ}</math>C typical</li> <li>Load life stability ratio under 0.1 Watt over 2000 hours at 80 <math>^{\circ}</math>C: 0.001 %</li> </ul>	
Hermetic Sealed Networks		1442, 1445, 1446, 1457, 1460	<ul style="list-style-type: none"> <li>TCR tracking: 0.5 ppm/<math>^{\circ}</math>C</li> <li>Ratio tolerance: 0.005 %</li> <li>Shelf life stability: 2 ppm typical</li> <li>Moisture resistance: <math>\Delta R = 0.003</math> % <math>\Delta</math>Ratio = 0.003 % typical</li> </ul>	<ul style="list-style-type: none"> <li>Mechanically robust</li> <li>Excellent stability</li> <li>Custom designs</li> </ul>
		VHAXXX VHP202 H-Series, Oil-Filled Hermetically Sealed Ultra Precision	<ul style="list-style-type: none"> <li>Resistance range: 5 <math>\Omega</math> to 1M84</li> <li>Tolerance: to <math>\pm 0.001</math> %</li> <li>TCR: <math>\pm 2</math> ppm/<math>^{\circ}</math>C (MIL range) typical</li> <li>Shelf life stability: 2 ppm typical</li> </ul>	<ul style="list-style-type: none"> <li>Very tight tolerance</li> <li>Wide ohmic value ranges</li> <li>Available in 4 terminal connections</li> </ul>
Hermetic Ultra-Precision Resistor with Almost Zero TCR		VHP100, 101, 102, 103	<ul style="list-style-type: none"> <li>Resistance range: 100 <math>\Omega</math> to 150 K<math>\Omega</math></li> <li>Tolerance: 0.005 %</li> <li>TCR of <math>\pm 0.3</math> ppm/<math>^{\circ}</math>C (15 <math>^{\circ}</math>C to 45 <math>^{\circ}</math>C, 25 <math>^{\circ}</math>C Ref) <math>\pm 0.6</math> ppm/<math>^{\circ}</math>C (- 55 <math>^{\circ}</math>C to + 125 <math>^{\circ}</math>C, + 25 <math>^{\circ}</math>C Ref)</li> <li>Shelf life stability: 2 ppm typical</li> </ul>	<ul style="list-style-type: none"> <li>No humidity effect, hermetically sealed against moisture</li> </ul>

\* Conformally coated.

## EXAMPLE 1. END PRODUCT: CARDIAC MAPPING SYSTEM REAL TIME DISPLAY OF HEART ELECTRICAL ACTIVITY

### Customer Schematic / Specifications:

- Ohmic value: 10K each
- Absolute tolerance: 0.005 %
- Ratio tolerance: 0.005 % between R1 to R4, and R5 to R8
- Absolute TCR (Temperature Coefficient of Resistance): 2 ppm/°C typical
- TCR tracking: 0.5 ppm/°C between R1 to R4, and R5 to R8

### Customer Requirements:

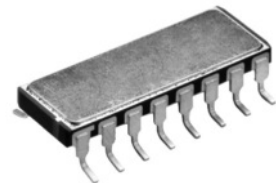
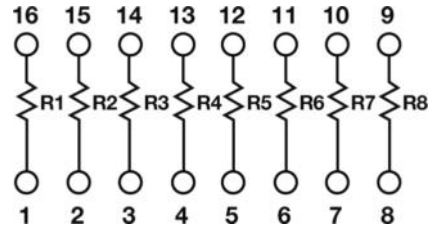
- High ratio stability under working conditions
- Surface mount device

### Foil Solution: VSM46

- Hermetically sealed high precision network – 16 terminals gull wing configuration.

### The Solution:

- Offers the best combination of tracking under power temperature during time of service life. The common behaviour of all resistors mounted into the same hermetic package contributes to maintain the excellent load life and ratio stability.
- Saves mounting time and real estate on PCB instead of using discrete resistors.



## EXAMPLE 2. END PRODUCT: TOMOGRAPHY CONTROL OF MAGNETIC FIELD ACTIVITY

### Customer Schematic / Specifications:

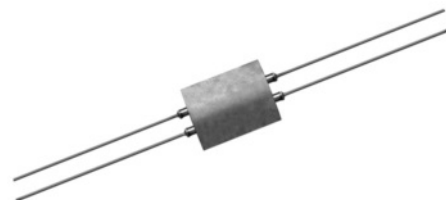
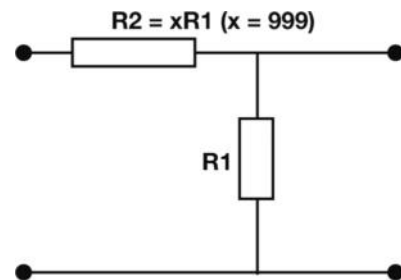
- Ultra precision attenuator with very high ohmic value ratio: 1:1000
- $R1 < 25 \Omega$
- $R2: 999 \times R1$
- Ratio definition:  $R1$  to  $(R1 + R2)$
- Initial attenuation accuracy: 0.003 %
- Total attenuation of ratio: (TCR + Shift Under Load): 0.005 % after 2000 hrs

### Foil Solution: VHA512 style – 4 terminals using Z foil technology

- Hermetically sealed oil filled network – custom design

### The Solution:

- High ratio stability: 0.005 % under working conditions and ambient temperature variations
- Extremely low absolute TCR of 0.2 ppm/°C
- Non-measurable shelf life drifts



**EXAMPLE 3. END PRODUCT: MINIATURE SENSORS  
WITH 3D MEDICAL IMAGING FOR A PRECISE DIAGNOSTICS AND SURGERY****Customer Schematic / Specifications:**

- Ultra precision current sensor
- Ohmic value: 0R2
- Absolute tolerance: 0.1 %
- Absolute TCR: 4 ppm/°C within +30 °C to +50 °C
- Working power: 0.05 W

**Customer Requirements:**

- Extremely tight TCR
- Very low PCR (Power Coefficient of Resistance)
- Low total error budget
- Tight absolute tolerance
- Surface mount device

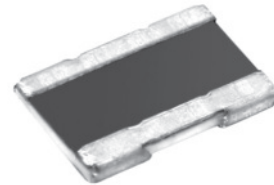
**Foil Solution: VCS1625Z**

- Ultra precision surface mount current sensing chip resistor,  
4 terminals

**The Solution:**

A small surface mount device with:

- Extremely low TCR: 0.2 ppm/°C - typical
- Very low PCR: 5 ppm at rated power
- Tight tolerance: 0.1 %



## Audio Noise Reduction Through the Use of Bulk Metal® Foil Resistors – “Hear the Difference”

### Introduction

As sound reproduction requirements become more demanding, the selection of circuit components becomes more exacting and the resistors in the signal path are critical. Amplifiers and pre-amplifiers, as well as volume controls, are likely sources for noise and signal distortion if the correct resistor selection is not made.

This paper describes the noise generation within the various available resistor types and quantifies the noise insertion to expect from each type.

### Noise

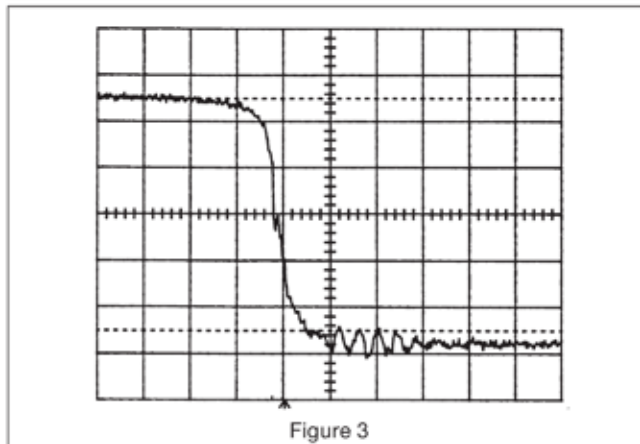
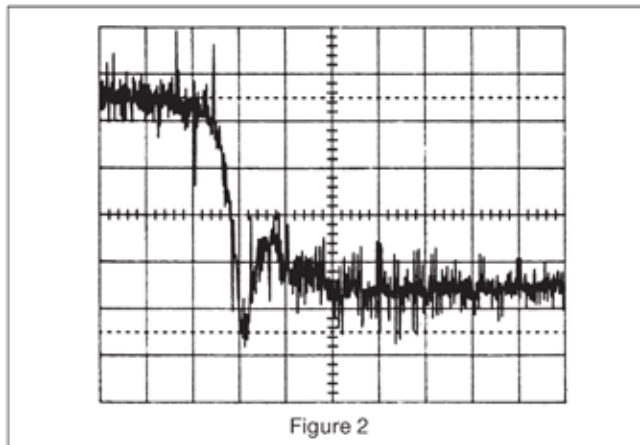
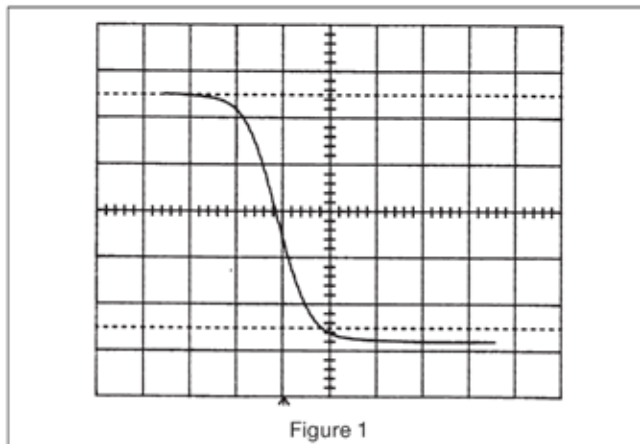
Noise is an unwanted AC signal that may be superimposed upon any fundamental signal including DC. In audio work the noise destroys the fidelity of sound reproduction and in the worst case can be totally unacceptable even to the untrained ear. Figure 1 shows a simple waveform segment. In Figure 2 a compliment of commercial parts yields a discernible amount of noise, while in Figure 3 the noise has been “cleaned up” by replacing the commercial parts with noise free components.

Resistors are noise sources to various degrees depending upon how they are made (resistor technology). As the systems become more and more sophisticated, better resistors are required. The hi-fidelity end of the sound reproduction industry is the primary target for noise free resistors. This is where component selection and circuit layout are done with purity of signal in mind and where designers can “hear the difference.”

There are two types of noise to consider. Thermal noise is due to the random motion of electrons within the resistive conductor. The voltage developed by thermal agitation sets a limit on the smallest voltage that can be amplified without being lost in a background of noise. The equation for thermal noise is:

$$E^2 = 4KTR (f_2 - f_1)$$

Where: K = BOLTSMAN'S constant  
 T = Absolute temperature (Kelvin)  
 R = Resistance of the conductor  
 (f<sub>2</sub> - f<sub>1</sub>) = Band width





The other type of noise is current noise, which is the bunching and releasing of electrons associated with current flow, and is present in resistors to varying degrees depending upon technology employed. Resistances composed of metal or metal alloys display the lowest combined noise level.

Current noise is measurable and is expressed as a function of the input voltage. The magnitude is micro volts per volt applied. A noise index is expressed in decibels and the equation converting  $\mu\text{V/V}$  to dB is:

$$\text{dB} = 20 \times \log (\text{noise voltage} / \text{DC voltage})$$

Table one equates the two:

Table 1	
dB	micro volts/volt
15	5.6
10	3.2
5	1.8
0	1.0
- 5	0.56
- 10	0.32
- 15	0.18
- 20	0.10
- 25	0.056
- 30	0.032
- 35	0.018
- 40	0.010

**Resistor Selection**

Persons interested in the quality of sound reproduction usually have a “trained ear” sufficiently perceptive to detect the insertion of noise and/or distortion of the original signal caused by the resistors in the preamp, audio amplifier, and/or volume control of a sound reproduction system. Audio engineers (who were not already using foil resistors) were sampled and asked to replace their previous resistor selection with foil resistors and “hear the difference.” In this high-end market there are no instruments to measure the fidelity of reproduction, so the “trained ear” is relied upon. All audio engineers sampled heard the difference. Below are comments from audio

engineers who are now using Vishay foil resistors:

*“I am (now) a user of Vishay resistors... They are the best in the industry... most notably for their sonic performance.”*

Emanuel Go, First Sound, Inc.

*“...Of all the different things I tried [to reduce noise], these [Vishay] resistors made a bigger difference compared to anything else...”*

Guy Hammel, Placete Engineering

*“We did a demonstration comparing foil to thin film and there was a hands down difference with the foil providing better sound, better resolution, and quieter outputs... Changing one resistor in the preamp feedback was enough for us to tell that it was a superior part.”*

Victor Tiscareno, AudioPrism

### **Bulk Metal® Foil Technology: - 40 dB**

Resistors made of metal alloys are resistive as a result of the intergranular boundaries between conductive metallic crystals in the alloy. These boundaries are quite long and therefore mask any local site distortions. The signal-to-noise ratio with these resistors is the best available.

Foil resistors are a pattern etched in metal. This planar geometry and the two axis design permits the current paths to be laid out in parallel producing self canceling of inductance. Also, path-to-path capacitance is in series resulting in a minimum of lumped internal capacitance. These low inductance/capacitance resistors cause the least amount of peak-to-peak distortion with no measurable noise insertion. Foil resistors are the first choice for noise-free operation.

### **Wirewound Technology: - 38 dB**

Wirewound resistors are made of alloys similar to foils, so the only noise insertion comes from the tabs used to connect the fine wire to the coarse external leads. The major objection to wirewounds, however, is the inductance that chops the peaks and fails to replicate the higher frequencies of the second and third harmonics.

### **Metal Film Technology: - 32 dB to - 16 dB**

Metal films are made by evaporating or sputtering a layer of nickel chromium onto a ceramic substrate. The thickness of the layer is value dependent and may be from 10 Angstrom to 500 Angstrom thick. The thicker it is



## Audio Noise Reduction Through the Use of Bulk Metal® Foil Resistors — “Hear the Difference”

(lower the value), the less noise insertion. Higher values are noisier because the occlusions, surface imperfections, and non-uniform depositions are more significant to the production of noise when the layer is thin.

Unlike foil resistors where the lines are generated by precise photo etching, here the spiral of resistance is generated by either grinding (which leaves a ragged edge) or laser adjusting (which leaves a curl edge with eddy-current paths), both of which are a source of noise.

### **Thick Film: - 18 dB to - 10 dB**

Thick film networks, discrete resistors, and chip resistors made of thick film can have unacceptable noise levels. The resistive path in this product is an “ink” of glass frit with ruthenium oxide added and screened onto a ceramic substrate. The conduction path is through the oxide particles as they touch one another in the fired glass binder. These “touching sites” are locations for the bunching and releasing of electrons and are the reason these resistors are noisy.

### **Carbon Composition: - 12 dB to + 6 dB**

These resistors were the backbone of the radio and television industry prior to World War II, but declined in use through

the early sixties as metal films took over. They eventually gave way completely to discrete metal film resistors as prices of metal films came down and the prices of carbon compositions went up. While noise reduction was not necessarily the driving factor, a significant size reduction accompanied this evolutionary step. Carbon composition resistors are made of carbon particles in a diallyl phthalate plastic binder and the conductive path is from particle to particle touching each other along the path. Unlike the glass binder of the thick film resistor, the plastic binder is subject to mechanical movement relative to the carbon due to the forces from voltage strain, moisture ingress, mechanical strain, and thermal strain. These strains cause the conduction sites at the point of contact to vary the resistivity or even open up. The current thus bounces around from one path to another with audible output. “Popcorn noise” as well as the current noise previously discussed is not uncommon.

### **Conclusion**

Signal purity can be a function of the selection of resistor technology for pre-amp and amplifier applications. Vishay Bulk Metal® Foil resistors offer the best performance for low noise audio applications.



## Guide for Choosing Resistors that are Exposed to Different Stresses

This document provides engineers with guidelines for choosing resistors that will best suit their application needs.

### INTRODUCTION

There is more to resistor precision than meets the eye. Resistors from different technologies may seem alike on the surface, and may often have similar published specifications; however, beneath the surface each is made differently. Inherent design and processing variations strongly influence electrical performances, leading to different behaviors after mounting.

Vishay Foil Resistors has established a new demonstration kit that illustrates the differences between foil, thin film, and thick film resistor technologies in real time. The purpose of the presentation is to give a perceptible explanation of the primary factors that influence resistor stability.

1. Temperature Coefficient of Resistance (TCR)
2. Power Coefficient of Resistance (PCR) or "ΔR due to self-heating"
3. Electrostatic Discharge (ESD)
4. Short Time Overload
5. Thermal EMF
6. Humidity Resistance

Temperature Coefficient of Resistance (TCR) is the best-known parameter used to specify a resistor's stability, and is used to depict the resistive element's sensitivity to temperature change due to ambient temperature variations.

Power Coefficient of Resistance (PCR) is a lesser-known, but still extremely important parameter. This parameter quantifies the resistance change due to self-heating when power is applied.

Electrostatic Discharge (ESD) damage to electronic devices can occur at any point in the component's life cycle, from manufacturing to field service. Generally, ESD damage is classified as either a catastrophic failure or latent defect. A catastrophic failure can be detected when the resistor is tested prior to shipment; but in the case of a latent defect, the damage will go undetected until the device fails in operation. A latent defect is more difficult to identify because a resistor that is exposed to an ESD event may be partially degraded, yet continue to perform its intended function. Premature

failure can occur after the resistor is already functioning in the finished product for a period of time.

Short Time Overload (STO) occurs when a circuit is subjected at one point in time to a temporary, unexpected high pulse (or overload) that can result in device failure.

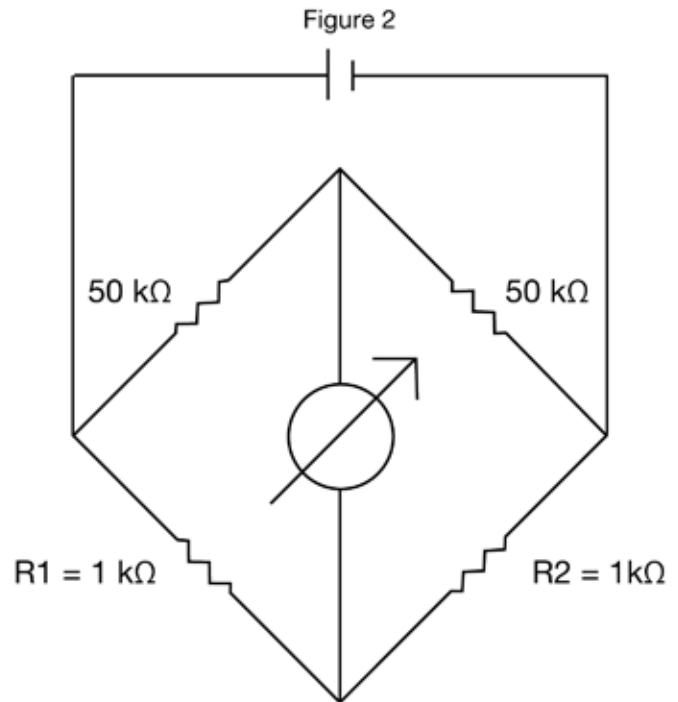
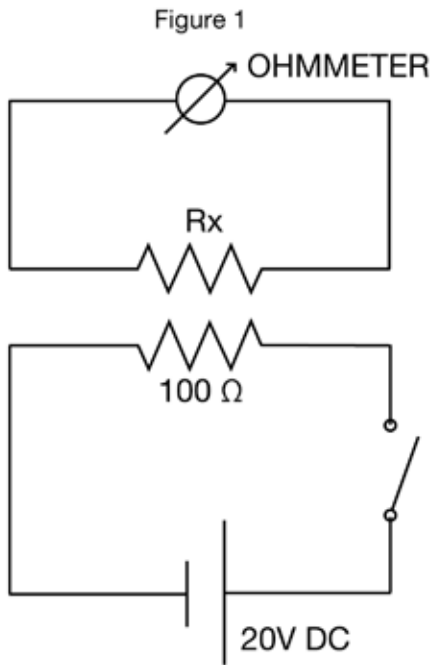
Thermal EMF, which is negligible in ordinary resistors, may become a significant noise source of drift or instability in high-precision resistors, and is considered a parasitic effect interfering with pure resistance. It is often caused by the dissimilarity of the materials used in the resistor construction, especially at the junction of the element and the lead materials. The thermal EMF performance of a resistor can be degraded by external temperature difference between the two junctions, dissymmetry of power distribution within the element, and the dissimilarity of the molecular activity of the metals involved.

Humidity from the environment can penetrate all resin coatings to varying degrees over time, and eventually reaches the resistive surface. When this occurs, damage can result when voltage applied to the resistor causes an electrolytic conversion of the resistive alloy into compounds at the inter-granular boundaries, causing the resistance to increase until failure.

Vishay Foil Resistors' demonstrations show the importance of taking TCR, PCR, ESD, STO, thermal EMF, and humidity resistance into consideration when striving to achieve high stability.

### TEMPERATURE COEFFICIENT OF RESISTANCE (TCR)

The TCR test consists of two electrically isolated circuits (see Figure 1). The test resistor (Rx) is connected to a precision ohmmeter on one circuit. The second circuit has a 100-Ω power resistor physically mounted to a substrate. A current is passed through the power resistor for a predetermined period of time. The temperature rise of the power resistor, and to Rx as a result, are predetermined time functions. After the heat rise of the resistor, the current flow through the power resistor is stopped, and Rx is monitored periodically as it cools down. The temperature coefficient is then calculated according to the resistance change of Rx relative to the temperature drop.



The temperature coefficient of Vishay Bulk Metal<sup>®</sup> foil resistors is the result of matching the variation in resistance of the alloy with temperature, and the variation of the resistance of the alloy with stress. These two effects occur simultaneously with changes in temperature. The result is an unusually low and predictable TCR.

Owing to the Bulk Metal foil resistor design, this TCR characteristic is accomplished automatically, without selection, and regardless of the resistance value or the date of manufacture — even if years apart!

## POWER COEFFICIENT OF RESISTANCE AND PCR TRACKING DEMONSTRATIONS

The power coefficient of resistance (PCR) demonstration operates as a basic bridge circuit (see Figure 2). The resistor under test is  $R_1$ . The other three legs of the bridge consist of high-Watt, low-TCR foil resistors designed and selected to ensure zero drift when voltage is applied across the bridge. For the PCR tracking demonstration,  $R_1$  and  $R_2$  represent the two resistors being tested. The other two legs of the bridge are high-value resistors, and therefore undergo an insignificant load.

The PCR test measures and graphs the stability of  $R_1$  relative to the other three legs of the bridge as it is subjected to continuous and increasing power. The graphic display shows the change in resistance of  $R_1$  from the nominal reading, measured in PPM. The nominal reading is taken at 0.1 W. Readings are then taken in 1/10-W increments up to 1 W for leaded parts, and 0.5 W for surface-mount units. The demonstration measures the PCR ( $\Delta R$  due to self-heating). The test results can indirectly indicate the TCR of the part.

The PCR tracking test measures and graphs the stability of  $R_1$  compared to  $R_2$  as they are subjected to continuous and increasing power. The graphic display shows the tracking stability between  $R_1$  and  $R_2$ , measured in PPM, under increasing loads. At 25 mW, the value of the target voltage divider,  $R_1$  and  $R_2$ , is read. The difference between  $R_1$  and  $R_2$  is set to zero, as shown graphically on the display. As subsequent readings are taken, the graph shows the change from the original  $R_1/R_2$  reading, measured in parts per million (ppm). The readings are taken in 25 mW increments up to 250 mW.

This demonstration measures the stability of the  $R_1/R_2$  ratio under increasing load within a voltage divider ( $\Delta R_1/R_2/\Delta P$ , measured as ppm/W). The change in ratio occurs as a result of the absolute TCR of the target resistors. Both resistors are simultaneously loaded with the same amount of power, but they don't heat up at the same rate, due to small differences in their thermal resistance. Therefore, the resistance of each resistor changes differently as a result of the TCR. If the two

resistors have nearly identical low TCR, they will exhibit very good tracking stability under applied power. However, if the resistors do not have a similarly low TCR, they will exhibit poor tracking under applied power.

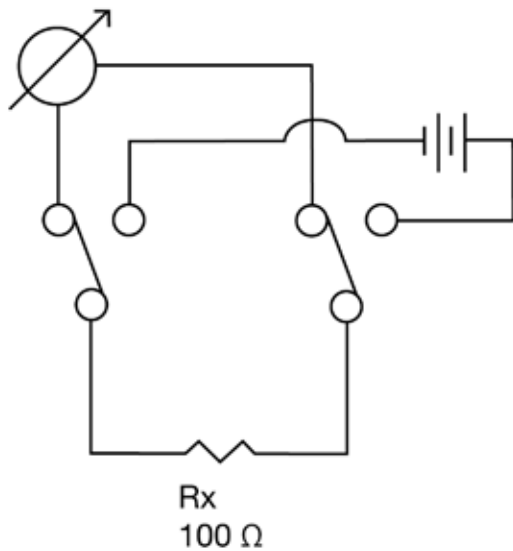
### SHORT-TIME OVERLOAD DEMONSTRATION

The tested resistor ( $R_x$ ) is connected to a 6.5 digit precision digital multi-meter (DMM), which takes the initial resistance reading (see Figure 3). After the reading is taken, the resistor is switched over to a power supply that applies an overload voltage for 5 seconds. After a sufficient cool-down time, the subject resistor is then switched back to the DMM, and the resistance is read again. The  $\Delta R$  is displayed.

The test measures the change in resistance of the subject resistor due to the applied overload. The screen displays the  $\Delta R$ , which is the difference in the resistance readings taken before and after the overload.

This demonstration measures the  $\Delta R$  (measured in PPM) of a 100-R resistor subjected to an overload of 7 W for 5 seconds. This overload exceeds the power ratings of each device under test, specifically by a factor of 11 for the Vishay VFCP2512, a factor of 9 for the Vishay VSMP2512 resistor, and a factor of 7.5 for the thin film resistors.

Figure 3



Foil resistors are about 100 times thicker than thin film. The high heat capacity of the foil resistor results in a low temperature rise of the resistor element under a 5 second pulse. The thin film resistors lack the pure mass (heat capacity) to handle the heat generated, and will typically burn up and fail.

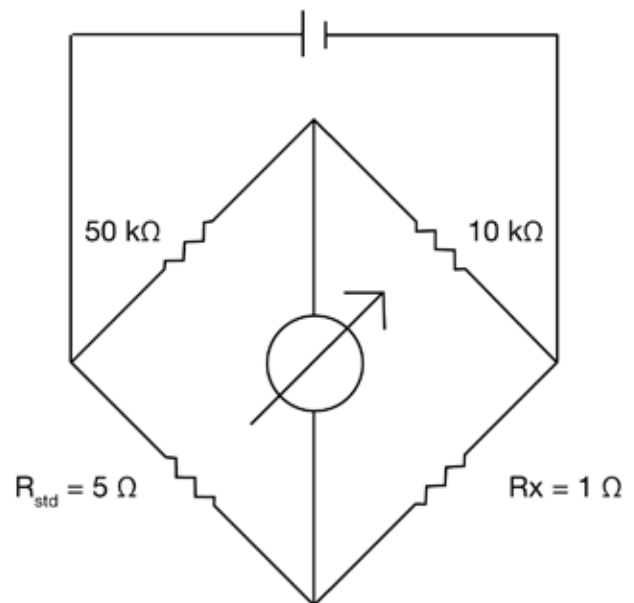
### CURRENT SENSE DEMONSTRATION

The current sense demonstration is a simple bridge circuit (see Figure 4). The tested resistor is  $R_x$ .  $R_{std}$  is a massive, high-power, low-TCR heat-sinked resistor capable of handling very high current while exhibiting zero drift. The other two legs of the bridge are comprised of high-Wattage, low-TCR foil resistors designed and selected to ensure zero drift when voltage is applied across the bridge.

The test measures and graphs the stability of  $R_x$  relative to  $R_{std}$  as it is subjected to continuous and increasing current (and voltage). The graphic display shows the change in resistance of  $R_x$  from the nominal reading, measured in ppm. The nominal reading is taken at 0.1 A. Readings are taken in 0.1-A increments up to 1 A.

This demonstration indirectly measures the power coefficient of resistance (PCR). The graphic display shows the change in resistance with increasing current ( $\Delta R/R$ )/ $\Delta I$ , measured as ppm/A. The test results indirectly indicate the PCR as a

Figure 4





function of Ohm's law. The subject resistor under test needs to have a resistance value of 1 ohm. The power can be calculated from Ohm's law using the ohmic value (1 ohm) and the current applied (in amps).

### ESD SENSITIVITY DEMONSTRATION

By using a 500-pF capacitor charged up to 4500 V, this demonstration shows that Vishay Bulk Metal foil resistors are not sensitive to electrostatic discharge (ESD) damage. The test, performed on a 10-kΩ resistor, begins with an initial 0.5-μs pulse at 2500 V. The unit is allowed time to cool down, after which the resistance measurement is taken and displayed in ppm deviation from the initial reading. Readings are then taken in 500-V increments up to 4500 V.\*

(\*) Tests up to 25 kV have been performed in Vishay-approved laboratories and have produced the same results.

### THERMAL EMF DEMONSTRATION

The test resistor (Rx) is electrically isolated from the second circuit and connected to a precision DC voltmeter, which measures in microvolts (Figure 6). In the second circuit, two power resistors are physically mounted very close to the terminations of Rx. Power can be directed separately to each of the resistors, heating each of Rx's terminations differently, causing a thermal difference between them. The thermal EMF created by this temperature difference generates a voltage. This voltage is then measured with the precision voltmeter.

A key feature of Vishay Bulk Metal foil resistors is their low thermal EMF design. The flattened paddle leads make intimate contact with the chip, thereby maximizing heat transfer and minimizing temperature variations. The resistor element is designed to uniformly dissipate power without creating hot spots, and the lead material is compatible with the element material. These design factors result in a very low-thermal-EMF resistor.

Figure 5

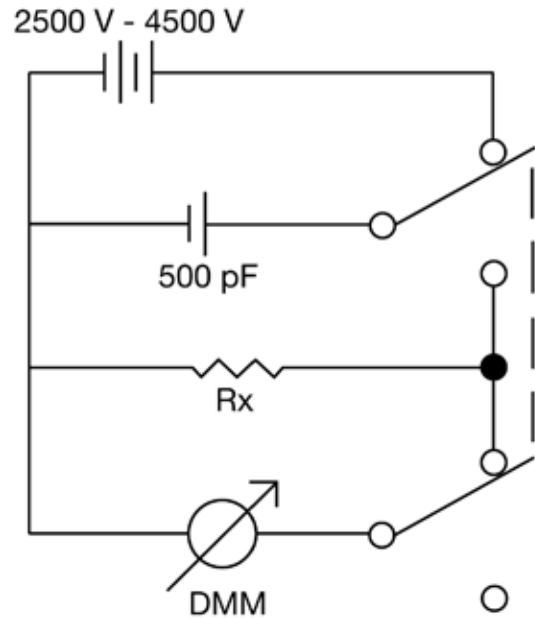
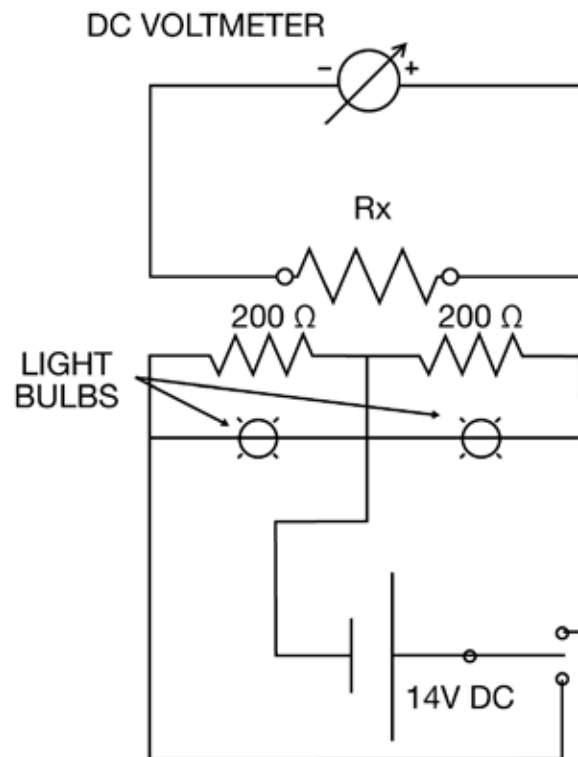


Figure 6



## Prototype Fastlane Service

Through our Prototype Fastlane Service (PFS), Vishay Bulk Metal® Foil precision resistors can be trimmed to any value within the resistance range for a given device and provided as a standard value (eg. 123.45  $\Omega$ ). Normally turnaround time for devices in stock is just 48 hours. Turnaround time for special-order devices is as fast as five business days.

At Vishay, we're dedicated to promoting successful relationships with all of our customers. One of the ways we help speed your time to market is by making prototype devices available quickly. The parts delivered by Vishay's Prototype Fastlane Service are the same parts as produced in our standard production, so they have all of the features and benefits of Foil Technology:

- Temperature Coefficient of Resistance (TCR)
  - Absolute:  $\pm 0.05$  ppm/ $^{\circ}\text{C}$  (0  $^{\circ}\text{C}$  to +60  $^{\circ}\text{C}$ ) typical
  - Tracking: 0.1 ppm/ $^{\circ}\text{C}$  typical
- Tolerance - Absolute:  $\pm 0.001$  % Match: 0.001 %
- Power Coefficient of Resistance (PCR) "ΔR due to self heating": 5 ppm typical at rated power with Z-Foil Technology
- Load Life Stability: to 0.005 % at 70  $^{\circ}\text{C}$ , 2000 hours at rated power
- Electrostatic Discharge (ESD) above 25 kV
- Any value at any tolerance within resistance range
- Matched sets available upon request

We can provide small quantities of prototype samples—at any required value—in a very short time frame and at a surprisingly low cost. In fact, some prototype samples can be provided free of charge. To learn more, please contact us at [foil@vishay.com](mailto:foil@vishay.com), or contact your regional FAE or Precision Center as listed in the Contacts section.

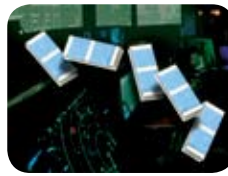


VSMP Series  
0805, 1206, 1506, 2010, 2512



- TCR  $\pm 0.05$  ppm/ $^{\circ}\text{C}^*$
- PCR: 5 ppm at rated power
- Tolerance:  $\pm 0.01$  %
- Range: 10  $\Omega$  to 150 k $\Omega$
- Power rating: 750 mW at 70  $^{\circ}\text{C}$

VFCD 1505  
Surface-Mount Divider



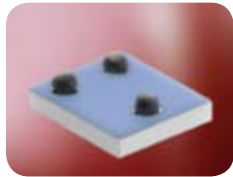
- TCR Tracking: 0.1 ppm/ $^{\circ}\text{C}$
- Absolute TCR:  $\pm 0.05$  ppm/ $^{\circ}\text{C}^*$
- PCR Tracking: 5 ppm at rated power
- Tolerance Match: 0.01 %
- Power rating: 100 mW at 70  $^{\circ}\text{C}$

DSMZ Molded  
Surface-Mount Divider



- TCR Tracking: 0.1 ppm/ $^{\circ}\text{C}$
- Absolute TCR:  $\pm 0.05$  ppm/ $^{\circ}\text{C}^*$
- PCR Tracking: 5 ppm at rated power
- Tolerance Match: 0.01 %
- Power rating: 100 mW for entire package

VFB1012D BGA  
Surface-Mount Divider



- TCR Tracking: 0.1 ppm/ $^{\circ}\text{C}$
- Absolute TCR:  $\pm 0.05$  ppm/ $^{\circ}\text{C}^*$
- PCR Tracking: 5 ppm at rated power
- Tolerance Match: 0.01 %
- Ball Grid Array

SMRDZ Molded  
Surface-Mount Resistor



- TCR:  $\pm 0.05$  ppm/ $^{\circ}\text{C}^*$
- PCR: 5 ppm at rated power
- Range: 5  $\Omega$  to 80 k $\Omega$
- Flexible terminations
- Non-inductive, non-capacitive design

SMNZ Molded 4 Resistor  
Surface-Mount Network



- TCR Tracking: 0.1 ppm/ $^{\circ}\text{C}$
- Absolute TCR:  $\pm 0.05$  ppm/ $^{\circ}\text{C}^*$
- PCR Tracking: 5 ppm at rated power
- Tolerance Match: 0.01 %
- Power rating: 100 mW per chip

CSM2512 and CSM3637 Metal Strip Element



- TCR:  $\pm 15$  ppm/ $^{\circ}\text{C}$  maximum
- Tolerance:  $\pm 0.1$  %
- Range: 2 m $\Omega$  to 200 m $\Omega$
- Power rating: up to 3 W at 70  $^{\circ}\text{C}$
- Maximum current: 38 A
- Thermal EMF < 3 $\mu\text{V}/^{\circ}\text{C}$

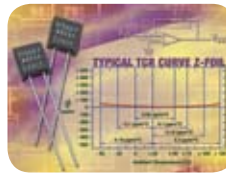


VCS1625Z, VCS1625  
current Sensor



- TCR  $\pm 0.05 \text{ ppm}/^\circ\text{C}^*$
- PCR: 5 ppm at rated power
- Range:  $0.01 \Omega$  to  $2 \Omega$
- 4-terminal (Kelvin) connection
- Thermal EMF  $< 0.1 \mu\text{V}/^\circ\text{C}$

Z201 Ultra-High-Precision  
Z-Foil Resistor



- TCR:  $\pm 0.05 \text{ ppm}/^\circ\text{C}^*$
- Tolerance:  $\pm 0.005 \%$
- PCR: 5 ppm at rated power
- Range:  $10 \Omega$  to  $100 \text{ k}\Omega$
- Drop-in replacement for S102C

VHP100 Ultra-High Precision,  
Zero-TCR Resistor



- Essentially zero TCR (Window)
- Tolerance:  $\pm 0.005 \%$  ppm
- Load life Stability:  $\pm 20$  ppm
- Shelf life Stability:  $\pm 2$  ppm
- Hermetically sealed, oil filled

Ultra-High-Precision  
Resistor for Metrology



- TCR:  $\pm 0.05 \text{ ppm}/^\circ\text{C}^*$
- Tolerance - Absolute and Match:  $\pm 0.001 \%$
- PCR: 5 ppm at rated power
- Range:  $5 \Omega$  to  $3.3 \text{ M}\Omega$
- Hermetically sealed, oil filled
- Shelf life stability: 2 ppm after at least 10 years

Custom Networks



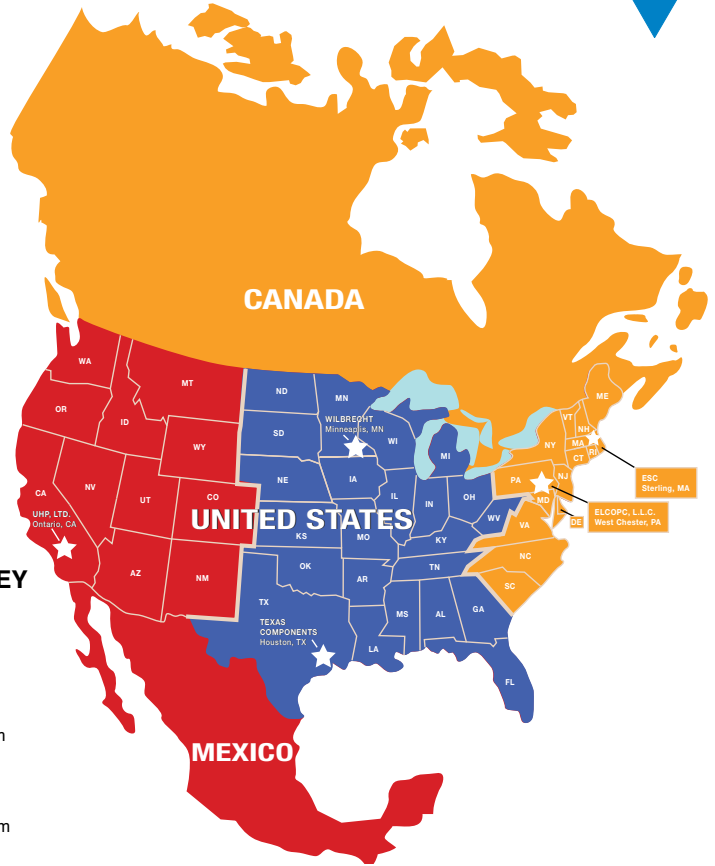
- TCR:  $\pm 2 \text{ ppm}/^\circ\text{C}$
- High flexibility of design schematics
- Tolerance - Absolute and Match:  $\pm 0.005 \%$
- Any combination of resistance values from  $5 \Omega$  to  $80 \text{ k}\Omega$
- No NRE charges

Trimmers



- TCR:  $\pm 25 \text{ ppm}/^\circ\text{C}$  Through the Wiper
- Settability:  $\pm 0.005 \%$
- Setting stability: to  $\pm 0.1 \%$
- Improved CRV
- "O" Ring seal

## North America



### FAE TERRITORY KEY

**Kip Reiner**

eMail: [kip.reiner@vishay.com](mailto:kip.reiner@vishay.com)  
tel: +1 (949) 349-0604

**Aaron Ram**

eMail: [aaron.ram@vishay.com](mailto:aaron.ram@vishay.com)  
tel: +1 (610) 407-4891

**Bill Demers**

eMail: [bill.demers@vishay.com](mailto:bill.demers@vishay.com)  
tel: +1 (603) 329-0149

## Europe

### TERRITORY KEY

**Rod Myall**

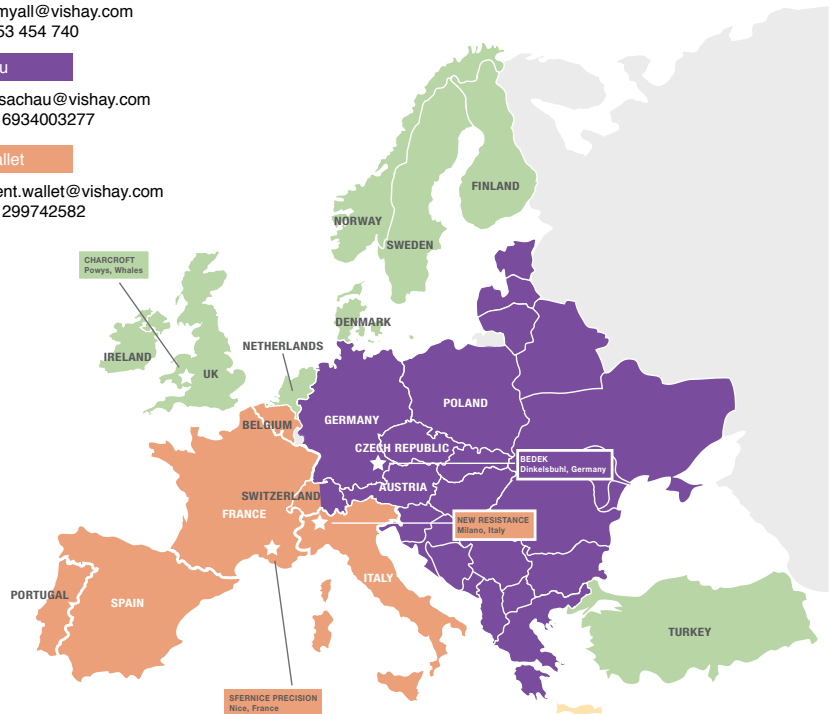
eMail: [rod.myall@vishay.com](mailto:rod.myall@vishay.com)  
tel: +44 1953 454 740

**Dirk Sachau**

eMail: [dirk.sachau@vishay.com](mailto:dirk.sachau@vishay.com)  
tel: +49 (0) 6934003277

**Laurent Wallet**

eMail: [laurent.wallet@vishay.com](mailto:laurent.wallet@vishay.com)  
tel: +33 (0) 299742582



South America



Kip Reiner

eMail: kip.reiner@vishay.com  
tel: +1 (949) 349-0604

Asia and Israel



Aaron Ram

eMail: aaron.ram@vishay.com  
tel: +1 (610) 407-4891

Hero Faienstein

eMail: hero.faienstein@vishay.com  
tel: +972 557 0834  
m: +972 54 3000 063

## SEMICONDUCTORS:

Rectifiers • High-Power Diodes and Thyristors • Small-Signal Diodes • Zener and Suppressor Diodes  
• FETs • RF Transistors • Optoelectronics • ICs • Modules

## PASSIVE COMPONENTS:

Resistive Products • Magnetics • Capacitors • Strain Gage Transducers and Stress Analysis Systems



One of the World's Largest Manufacturers of  
**Discrete Semiconductors and Passive Components**

## WORLDWIDE SALES CONTACTS

### THE AMERICAS

#### UNITED STATES

VISHAY AMERICAS  
ONE GREENWICH PLACE  
SHELTON, CT 06484  
UNITED STATES  
PH: +1-402-563-6866  
FAX: +1-402-563-6296

### ASIA

#### SINGAPORE

VISHAY INTERTECHNOLOGY ASIA PTE LTD.  
25 TAMPINES STREET 92  
KEPPEL BUILDING #02-00  
SINGAPORE 528877  
PH: +65-6788-6668  
FAX: +65-6788-0988

#### P.R. CHINA

VISHAY TRADING (SHANGHAI) CO., LTD.  
15D, SUN TONG INFOPORT PLAZA  
55 HUAI HAI WEST ROAD  
SHANGHAI 200030  
P.R. CHINA  
PH: +86-21-5258 5000  
FAX: +86-21-5258 7979

#### JAPAN

VISHAY JAPAN CO., LTD.  
MG IKENOHATA BLDG. 4F  
1-2-18, IKENOHATA  
TAITO-KU  
TOKYO 110-0008  
JAPAN  
PH: +81-3-5832-6210  
FAX: +81-3-5832-6260

### EUROPE

#### GERMANY

VISHAY EUROPE SALES GMBH  
GEHEIMRAT-ROSENTHAL-STR. 100  
95100 SELB  
GERMANY  
PH: +49-9287-71-0  
FAX: +49-9287-70435

#### FRANCE

VISHAY S.A.  
199, BLVD DE LA MADELEINE  
06003 NICE, CEDEX 1  
FRANCE  
PH: +33-4-9337-2920  
FAX: +33-4-9337-2997

#### UNITED KINGDOM

VISHAY LTD.  
PALLION INDUSTRIAL ESTATE  
SUNDERLAND SR4 6SU  
UNITED KINGDOM  
PH: +44-191-514-4155  
FAX: +44-191-567-8262