

STANDARD DIODES

SUPER MAGN-A-pak™ Power Modules

Features

- High current capability
- 3000 V_{RMS} isolating voltage with non-toxic substrate
- High surge capability
- High voltage ratings up to 2000V
- Industrial standard package
- UL E78996 approved 
- RoHS Compliant

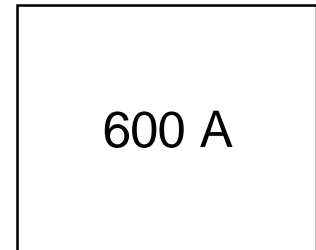

Typical Applications

- Rectifying bridge for large motor drives
- Rectifying bridge for large UPS

Major Ratings and Characteristics

Parameters	IRKD600..	Units
I _{F(AV)}	600	A
	@ T _C	100 °C
I _{F(RMS)}	942	A
	@ T _C	100 °C
I _{FSM}	@ 50Hz	19.0 KA
	@ 60Hz	20.1 KA
I ² t	@ 50Hz	1805 KA ² s
	@ 60Hz	1683 KA ² s
I ² /t	18050	KA ² /s
V _{RRM} range	800 to 2000	V
T _{STG} range	-40 to 150	°C
T _J range	-40 to 150	°C

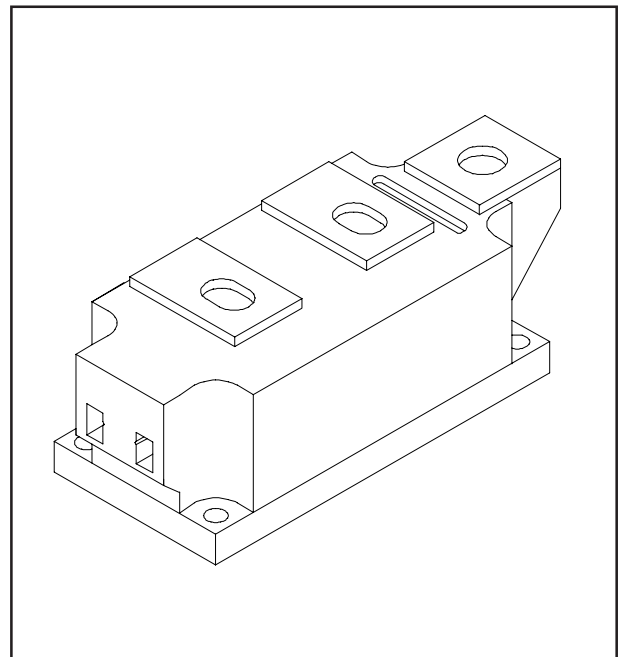

ELECTRICAL SPECIFICATIONS

Voltage Ratings

Type number	Voltage Code	V_{RRM} , maximum repetitive peak reverse voltage V	V_{RSM} , maximum non-repetitive peak rev. voltage V	I_{RRM} max. @ T_J max. mA
IRKD600..	08	800	900	50
	12	1200	1300	
	16	1600	1700	
	20	2000	2100	

Forward Conduction

Parameter	IRKD600..	Units	Conditions
$I_{F(AV)}$ Maximum average forward current @ Case temperature	600	A	180° conduction, half sine wave
	100	°C	
$I_{F(RMS)}$ Maximum RMS forward current	942	A	180° conduction, half sine wave @ $T_C = 100^\circ\text{C}$
I_{FSM} Maximum peak, one-cycle forward, non-repetitive surge current	19.0	KA	t = 10ms No voltage
	20.1		t = 8.3ms reapplied
	16.2		t = 10ms 100% V_{RRM}
	17.2		t = 8.3ms reapplied
I^2t Maximum I^2t for fusing	1805	KA ² s	t = 10ms No voltage
	1683		t = 8.3ms reapplied
	1319		t = 10ms 100% V_{RRM}
	1230		t = 8.3ms reapplied
$I^2\sqrt{t}$ Maximum $I^2\sqrt{t}$ for fusing	18050	KA ² √s	t = 0.1 to 10ms, no voltage reapplied
$V_{F(TO)1}$ Low level value of threshold voltage	0.70	V	$(16.7\% \times \pi \times I_{F(AV)} < I < \pi \times I_{F(AV)})$, $T_J = T_J$ max.
$V_{F(TO)2}$ High level value of threshold voltage	0.77		$(I > \pi \times I_{F(AV)})$, $T_J = T_J$ max.
r_{f1} Low level value of forward slope resistance	0.28	mΩ	$(16.7\% \times \pi \times I_{F(AV)} < I < \pi \times I_{F(AV)})$, $T_J = T_J$ max.
r_{f2} High level value of forward slope resistance	0.25		$(I > \pi \times I_{F(AV)})$, $T_J = T_J$ max.
V_{FM} Maximum forward voltage drop	1.24	V	$I_{pk} = 1800\text{A}$, $T_J = 25^\circ\text{C}$, $t_p = 10\text{ms}$ sine pulse

Blocking

Parameter	IRKD600..	Units	Conditions
V_{INS} RMS isolation voltage	3000	V	t = 1 s
I_{RRM} Maximum peak reverse and off-state leakage current	50	mA	$T_J = T_J$ max., rated V_{RRM} applied

Thermal and Mechanical Specifications

Parameter	IRKD600..	Units	Conditions
T _J Max. junction operating temperature range	- 40 to 150	°C	
T _{stg} Max. storage temperature range	- 40 to 150		
R _{thJC} Max. thermal resistance, junction to case	0.065	K/W	Per junction, DC operation
R _{thC-hs} Max. thermal resistance, case to heatsink	0.02	K/W	
T Mounting torque ± 10%SMAP to heatsink busbar to SMAP	6 - 8 12 - 15	Nm	A mounting compound is recommended and the torque should be rechecked after a period of 3 hours to allow for the spread of the compound
wt Approximate weight	1500		
Case style	SUPERMAGN-A-pak		See outline table

ΔR_{thJC} Conduction

(The following table shows the increment of thermal resistance R_{thJC} when devices operate at different conduction angles than DC)

Conduction angle	Sinusoidal conduction	Rectangular conduction	Units	Conditions
180°	0.009	0.006	0.015 0.022 0.037	K/W T _J = T _J max.
120°	0.011	0.011		
90°	0.014	0.014		
60°	0.021	0.021		
30°			0.037	0.038

Ordering Information Table

Device Code

IRK	D	600	-	20
①	②	③		④

- 1 - Module type
- 2 - Circuit configuration D = 2 diodes in series
- 3 - Current rating
- 4 - Voltage code: Code x 100 = V_{RRM} (See Voltage Ratings Table)

Outline Table

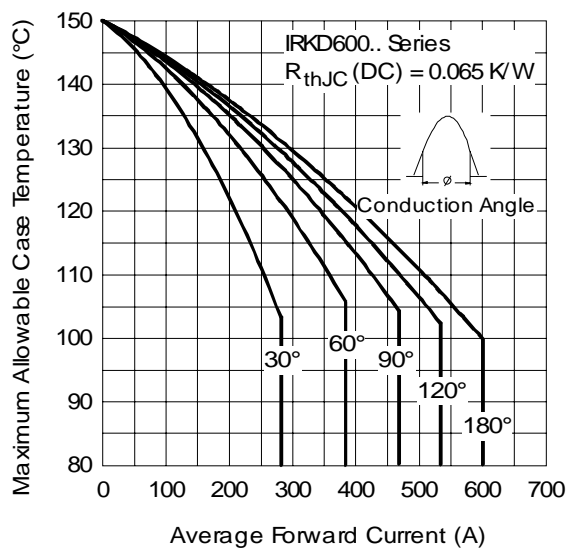
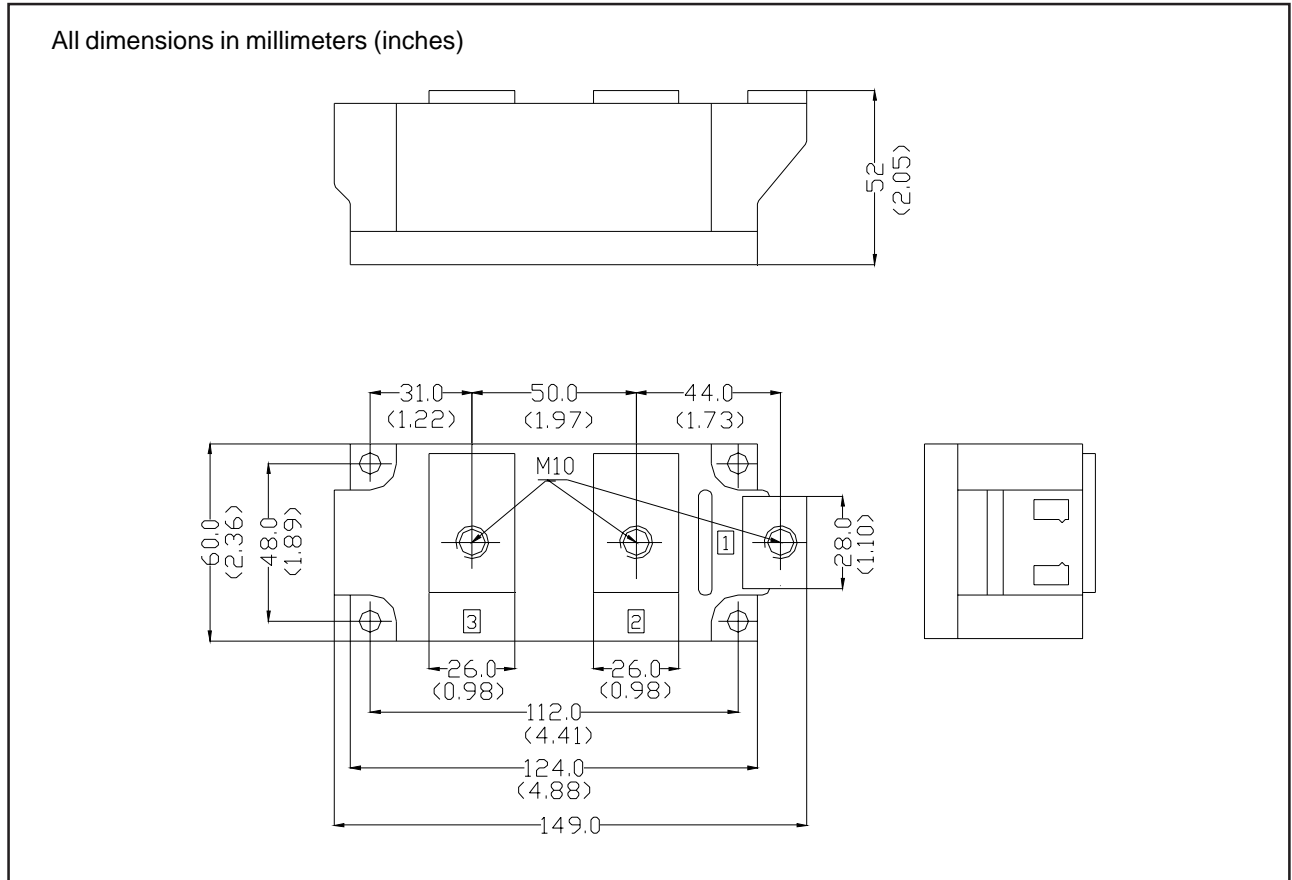

Fig. 1 - Current Ratings Characteristics

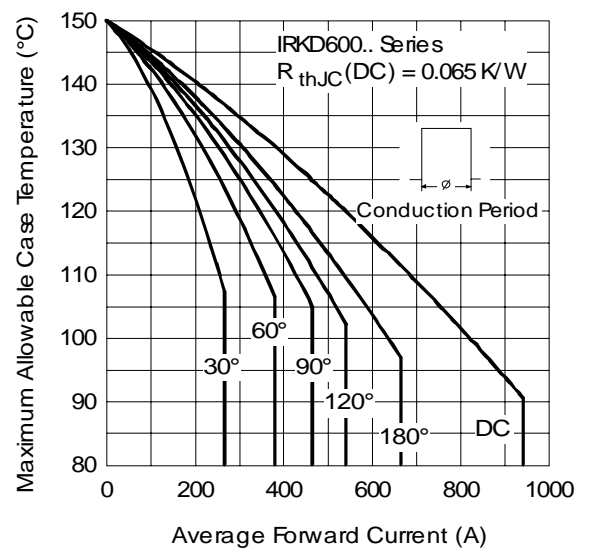

Fig. 2 - Current Ratings Characteristics

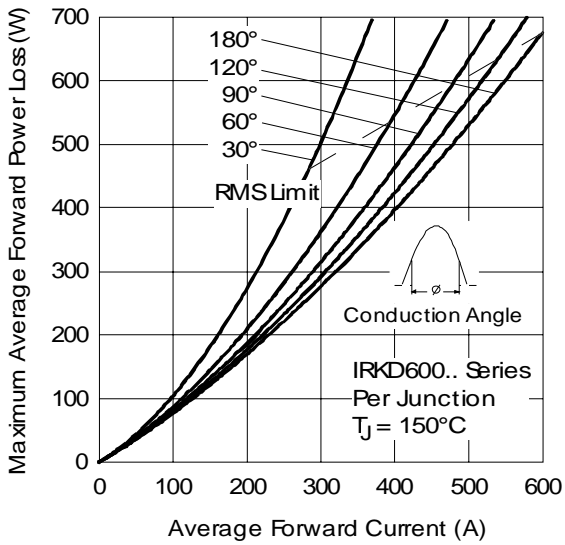

Fig. 3 - Forward Power Loss Characteristics

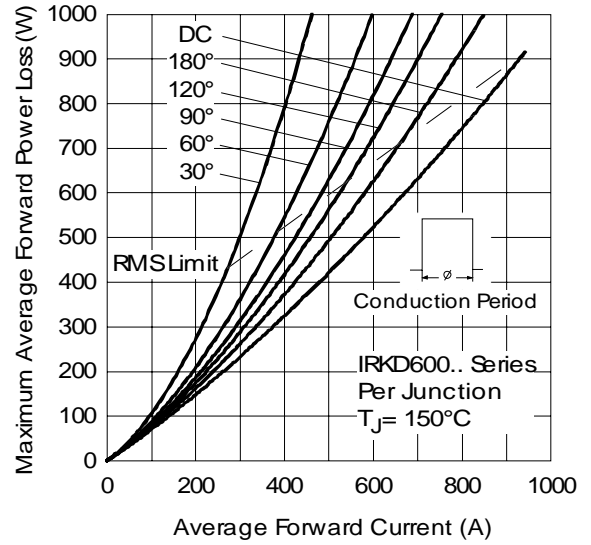

Fig. 4 - Forward Power Loss Characteristics

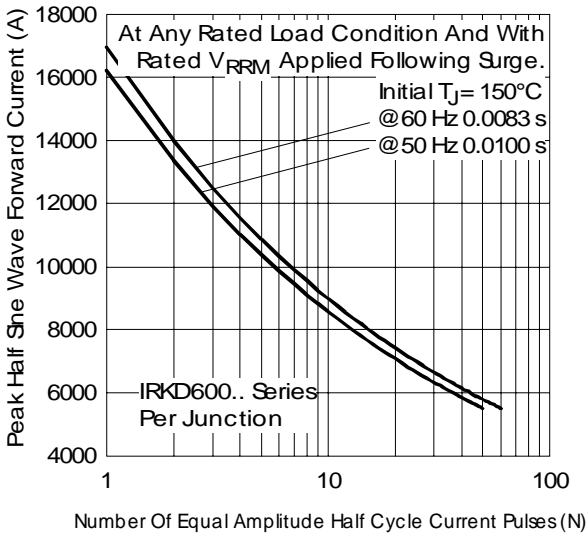

Fig. 5 - Maximum Non-Repetitive Surge Current

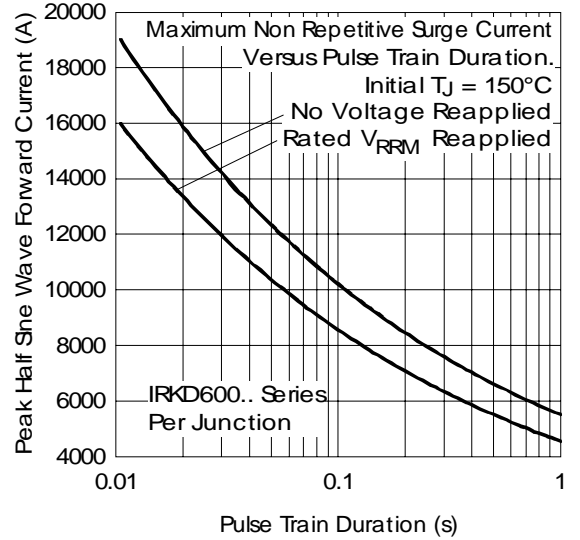

Fig. 6 - Maximum Non-Repetitive Surge Current

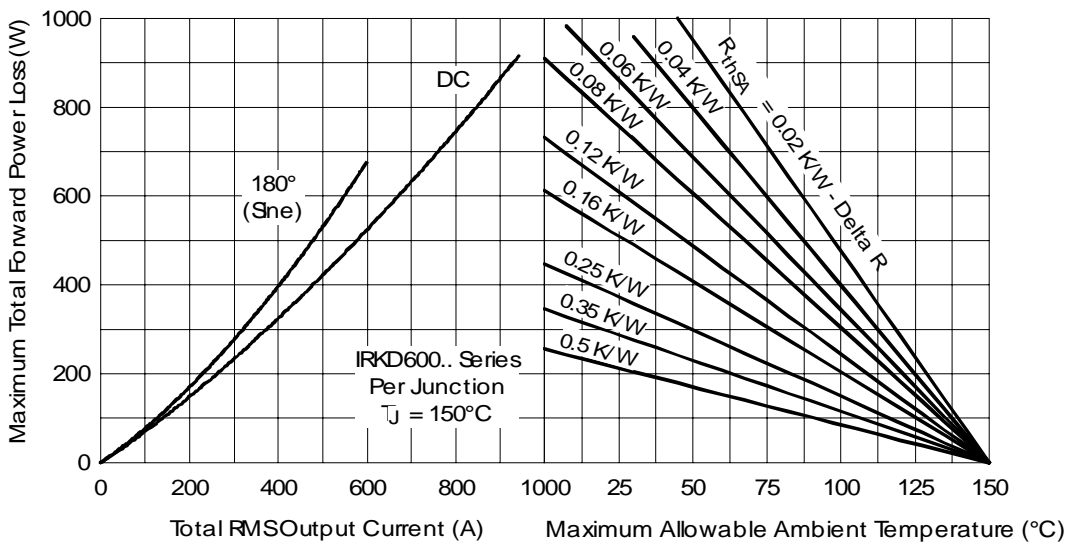

Fig. 7 - Forward Power Loss Characteristics

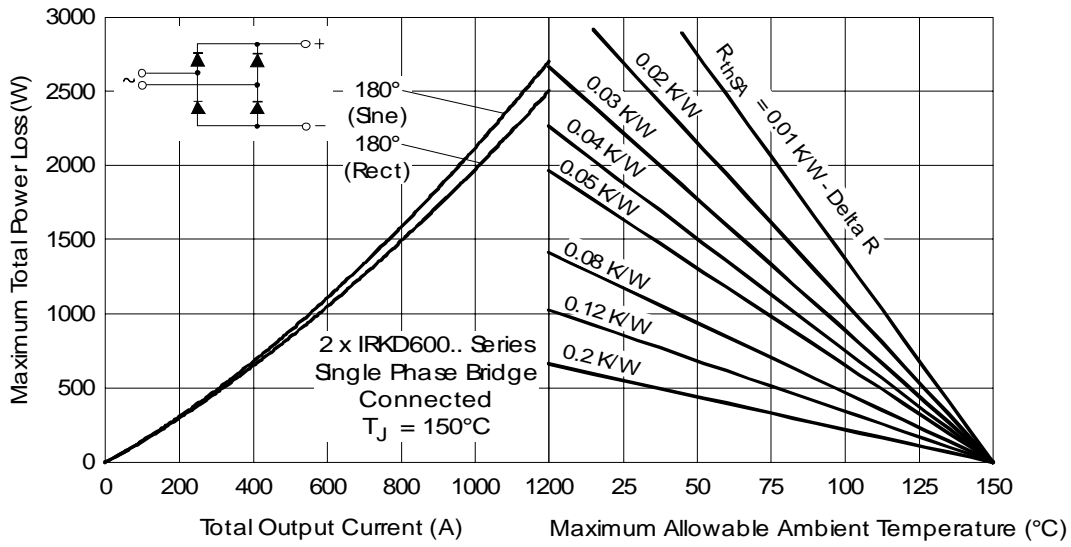

Fig. 8 - Forward Power Loss Characteristics

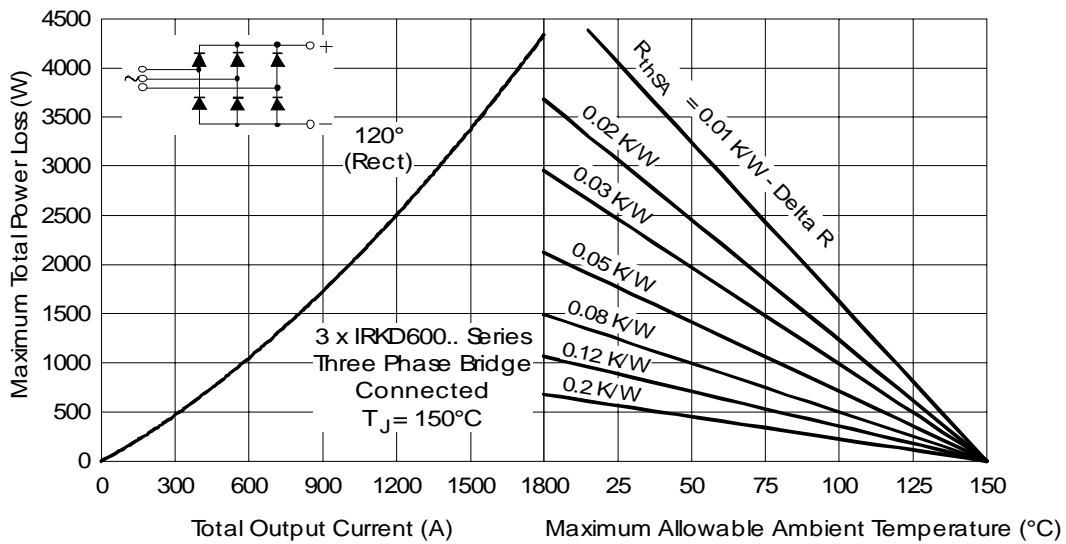

Fig. 9 - Forward Power Loss Characteristics

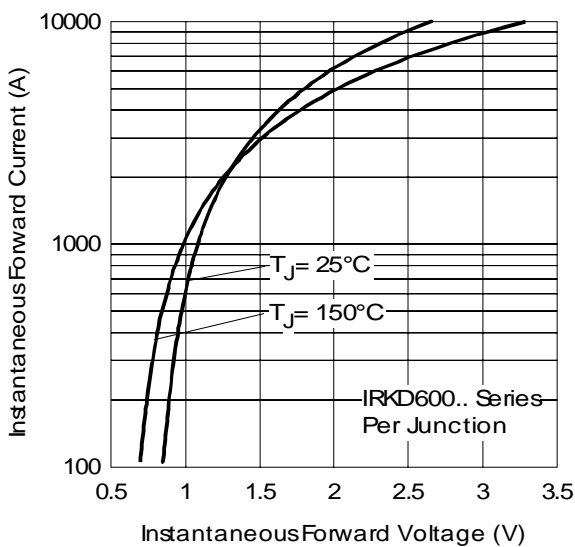

Fig. 10 - Forward Voltage Drop Characteristics

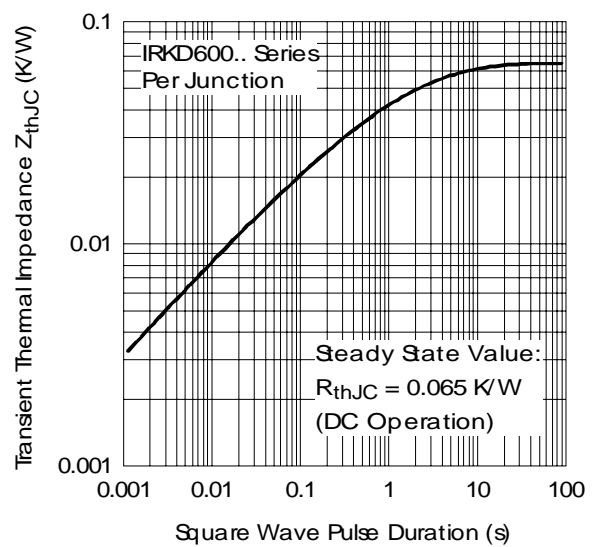

Fig. 11 - Thermal Impedance Z_{thJC} Characteristic

Data and specifications subject to change without notice.
This product has been designed and qualified for Industrial Level.
Qualification Standards can be found on IR's Web site.

International
IOR Rectifier

IR WORLD HEADQUARTERS: 233 Kansas St., El Segundo, California 90245, USA Tel: (310) 252-7105
TAC Fax: (310) 252-7309
09/06



Notice

The products described herein were acquired by Vishay Intertechnology, Inc., as part of its acquisition of International Rectifier's Power Control Systems (PCS) business, which closed in April 2007. Specifications of the products displayed herein are pending review by Vishay and are subject to the terms and conditions shown below.

Specifications of the products displayed herein are subject to change without notice. Vishay Intertechnology, Inc., or anyone on its behalf, assumes no responsibility or liability for any errors or inaccuracies.

Information contained herein is intended to provide a product description only. No license, express or implied, by estoppel or otherwise, to any intellectual property rights is granted by this document. Except as provided in Vishay's terms and conditions of sale for such products, Vishay assumes no liability whatsoever, and disclaims any express or implied warranty, relating to sale and/or use of Vishay products including liability or warranties relating to fitness for a particular purpose, merchantability, or infringement of any patent, copyright, or other intellectual property right.

The products shown herein are not designed for use in medical, life-saving, or life-sustaining applications. Customers using or selling these products for use in such applications do so at their own risk and agree to fully indemnify Vishay for any damages resulting from such improper use or sale.

International Rectifier®, IR®, the IR logo, HEXFET®, HEXSense®, HEXDIP®, DOL®, INTERO®, and POWIRTRAIN® are registered trademarks of International Rectifier Corporation in the U.S. and other countries. All other product names noted herein may be trademarks of their respective owners.