

PART NUMBER: VSCP-1K5 series

DESCRIPTION: switching power supply

features

- current sharing capability
- 0.98 typical power factor
- programmable output voltage
- universal AC input
- short circuit, overload, over voltage, over temperature protected
- forced air cooling by built-in DC fan
- power failure signal
- built-in remote sense
- built-in remote inhibit
- 2 year warranty



model	output ¹	output current		max. power	regulation	ripple & noise ³		efficiency
		minimum	maximum ²			(Vpp)		
VSCP-1K5-09	9 V	0 A	88/166 A	1500 W	<1%	1%	83%	
VSCP-1K5-12	12 V	0 A	66/125 A	1500 W	<1%	1%	84%	
VSCP-1K5-15	15 V	0 A	53/100 A	1500 W	<1%	1%	85%	
VSCP-1K5-18	18 V	0 A	44/83.3 A	1500 W	<1%	1%	85%	
VSCP-1K5-24	24 V	0 A	33/62 A	1500 W	<1%	1%	88%	
VSCP-1K5-36	36 V	0 A	22/41.6 A	1500 W	<1%	1%	88%	
VSCP-1K5-48	48 V	0 A	16/31 A	1500 W	<1%	1%	89%	
VSCP-1K5-60	60 V	0 A	13/25 A	1500 W	<1%	1%	90%	

notes:

- 1 output voltage is measured at output power connector.
- 2 maximum current is measured at 100-120V input / 200-240V input
- 3 ripple and noise is measured from 10 KHz to 20 MHz at output terminals with 0.1 μ F ceramic capacitor and a 22 μ F electrolytic capacitor in parallel.

INPUT

parameter	conditions/description	min	nom	max	units
input frequency		47		63	Hz
input voltage	100~120 / 200~240 VAC (see derating curve) (130~185 / 260~370) (VDC see derating curve)	100		240	VAC
input current		9.0		230	A
inrush current	peak measured at 230 VAC, cold start			120	A

PART NUMBER: VSCP-1K5 series

DESCRIPTION: switching power supply

OUTPUT

parameter	conditions/description	min	nom	max	units
hold-up time	full load at 230 VAC			12	mS
programming	output voltage programmable through external 0~5V control voltage on VCI. control voltage can also be obtained from VCO via a 470 KOhm pot. see application diagrams.	25		100	%
voltage adjustability	typical adjustment by potentiometer 25%-100% adjustment by 1-5Vdc external control	-7.5		+7.5	%
temp. coefficient			±0.04		%/°C

PROTECTION CIRCUIT

parameter	conditions/description	min	nom	max	units
overload	current limiting 3 times (1.5", 3.0", 5.0"), then intelligent auto recovery before shutdown				
overvoltage		110		135	%

GENERAL AND SAFETY

parameter	conditions/description	min	nom	max	units
operating temp.		0		50	°C
operating humid.		20%		90%	RH
storage temp.		-20		85	°C
storage humid.		10		95%	RH
vibration	period of 60 min. for each axis	10		200	Hz
EMC	EN55022, EN610000-4-2,3,4,5,6,8,11, EN61000-3-2-3 ENV50204				
safety regulation	approved to UL/cUL 1950, TUV EN60950				
leakage current	at 240 VAC			<7.0	mA
cooling	power rating and temperature controlled fan				

MECHANICAL

parameter	conditions/description	min	nom	max	units
weight			4.5		Kg
enclosure	290(L) x 120(W) x 132.5(H)				mm

LOGIC CONNECTOR

parameter	conditions/description
pin assignments:	1. INH - remote on-off / remote inhibit 2. GND - return / output ground 3. PAR - current sharing / parallel function 4. FAL - AC fail detect (must use 2KΩ pull up resistor) 5. VCO - reference output voltage (5-10 VDC) to be used for output programming 6. VCI - command input voltage for output programming 7. VS(-) - remote sense (-) 8. VS(+) - remote sense (+)

PART NUMBER: VSCP-1K5 series

DESCRIPTION: switching power supply

LOGIC CONNECTIONS

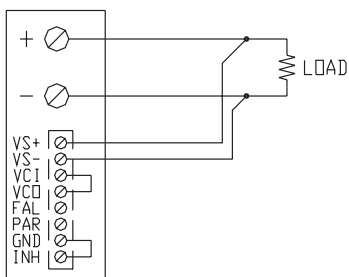

REMOTE SENSING

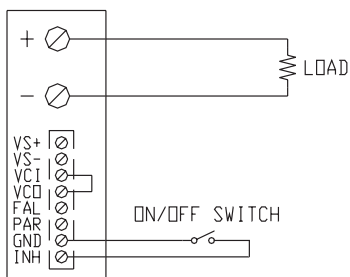

ON/OFF CONTROL BY SWITCH

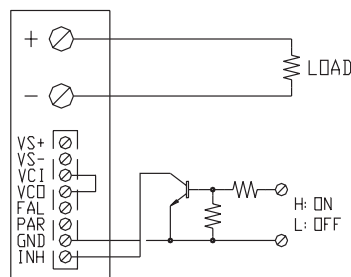

ON/OFF CONTROL BY TRANSISTOR

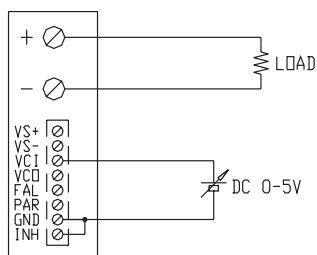

OUTPUT VOLTAGE ADJUST WITH DC 0-5V

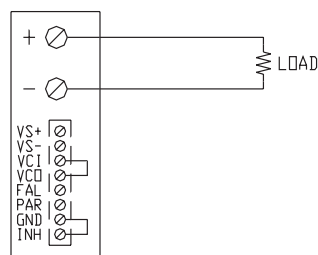

USING INTERNAL VOLTAGE CONTROL

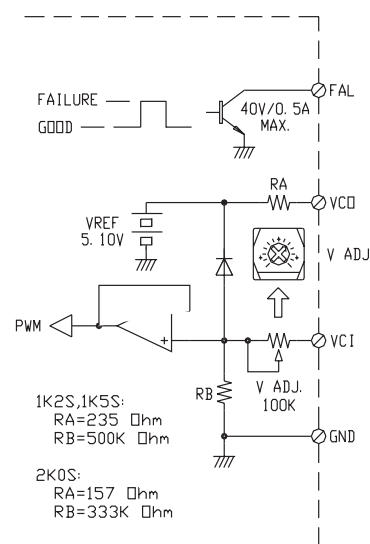

VCI AND VCO SIGNAL

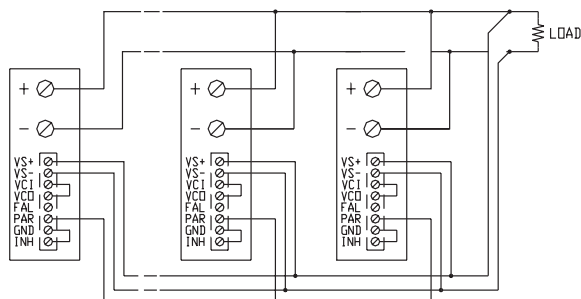

PARALLEL OPERATION WITH REMOTE SENSING

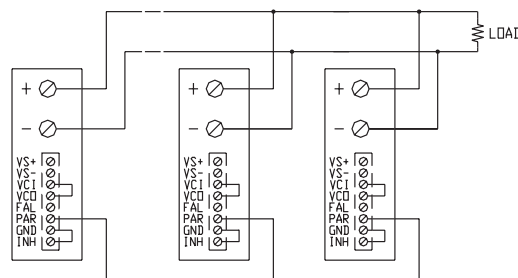

PARALLEL OPERATION WITHOUT REMOTE SENSING

PART NUMBER: VSCP-1K5 series

DESCRIPTION: switching power supply

MECHANICAL DRAWING

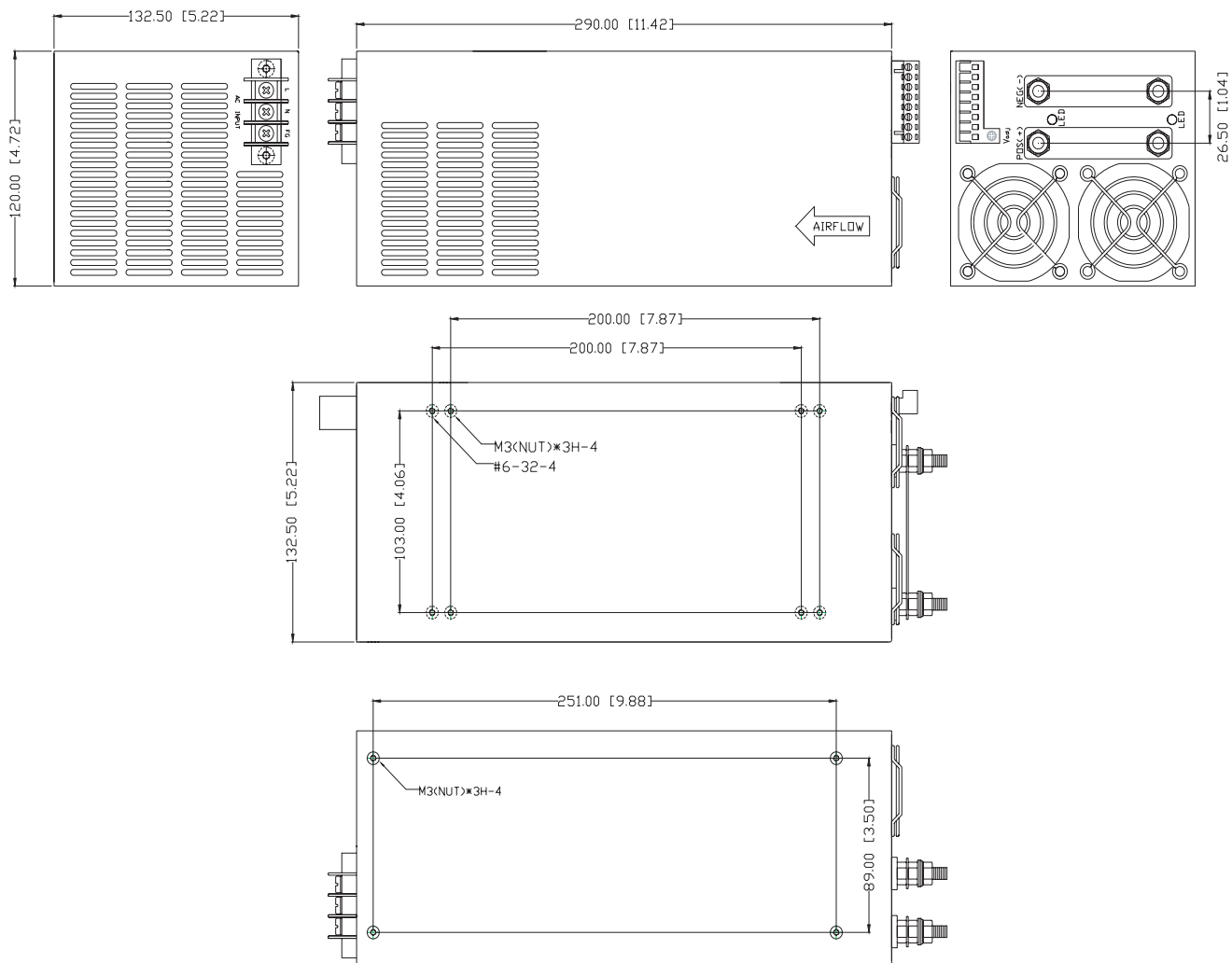

CONTROL PIN ASSIGMENT

VS+	Output Voltage Remote Sense+
VS -	Output Voltage Remote Sense -
VCI	Command input voltage for output programming
VCO	5-10 VDC reference for output programming
FAL	Power Failure detect
PG	Power Good Signal
PAR	Current Sharing / Parallel function
GND	Return / Output Ground
INH	Inhibit / Remote On-Off

PART NUMBER: VSCP-1K5 series

DESCRIPTION: switching power supply

DERATING CURVES

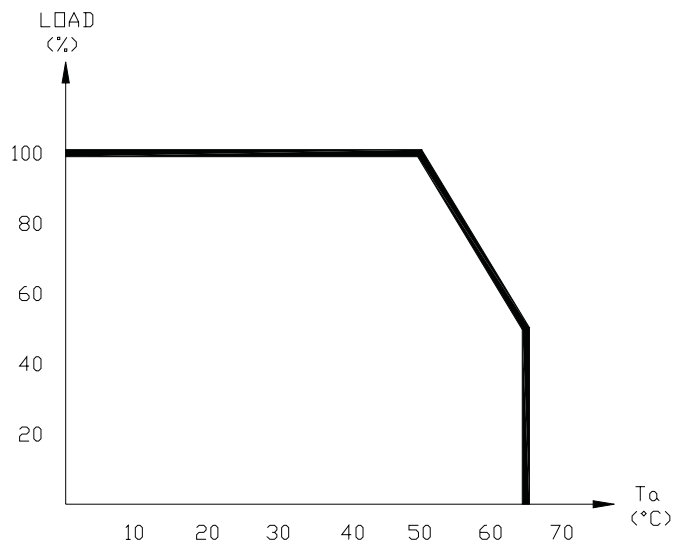

load derating curve

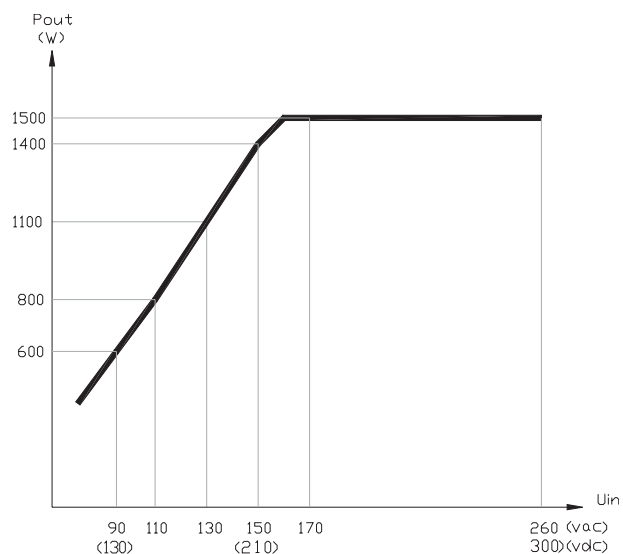

output power vs. input voltage derating curve