

Zener diode

VDZ8.2B

●Application

Voltage regulation

●Features

- 1) Ultra small mold type (VMD2).
- 2) High reliability.
- 3) By chip-mounter, automatic mounting is possible.

●Construction

Silicon Epitaxial Planer

●External dimensions (Unit : mm)

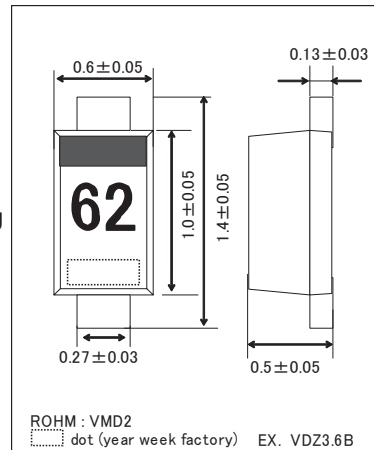

●Land size figure (Unit : mm)

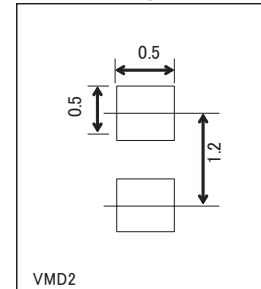

●Structure

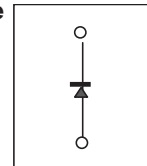

●Taping specification (Unit : mm)

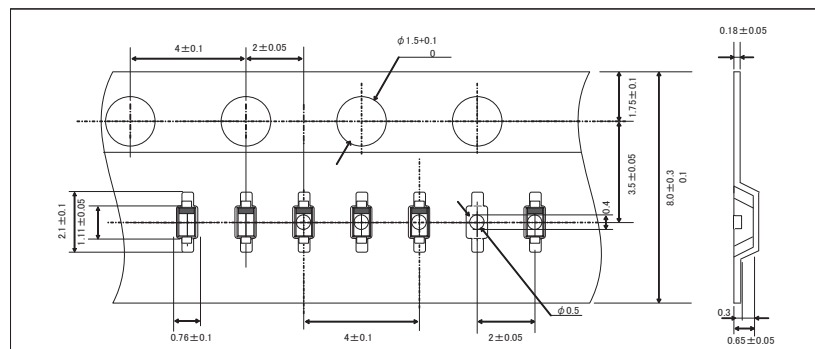

●Absolute maximum ratings (Ta=25°C)

Parameter	Symbol	Limits	Unit
Power dissipation	P	100	mW
Junction temperature	T _j	150	°C
Storage temperature	T _{stg}	-55 to +150	°C
Operating temperature	T _{opr}	-55 to +150	°C

Diodes

●Electrical characteristics (Ta=25°C)

TYP.	Symbol								
	Zener voltage: Vz(V)			Operating resistance: Zz(Ω)		Rising operating resistance: Zz(Ω)		Reverse current: IR(μA)	
	MIN.	MAX.	Iz(mA)	MAX.	Iz(mA)	MAX.	Iz(mA)	MAX.	VR(V)
VDZ 3.6B	3.600	3.845	5.0	100	5.0	1000	1.0	10.0	1.0
VDZ 3.9B	3.890	4.160	5.0	100	5.0	1000	1.0	5.0	1.0
VDZ 4.3B	4.170	4.430	5.0	100	5.0	1000	1.0	5.0	1.0
VDZ 4.7B	4.550	4.750	5.0	100	5.0	800	0.5	2.0	1.0
VDZ 5.1B	4.980	5.200	5.0	80	5.0	500	0.5	2.0	1.5
VDZ 5.6B	5.490	5.730	5.0	60	5.0	200	0.5	1.0	2.5
VDZ 6.2B	6.060	6.330	5.0	60	5.0	100	0.5	1.0	3.0
VDZ 6.8B	6.650	6.930	5.0	40	5.0	60	0.5	0.5	3.5
VDZ 7.5B	7.280	7.600	5.0	30	5.0	60	0.5	0.5	4.0
VDZ 8.2B	8.020	8.360	5.0	30	5.0	60	0.5	0.5	5.0
VDZ 9.1B	8.850	9.230	5.0	30	5.0	60	0.5	0.5	6.0
VDZ 10B	9.770	10.210	5.0	30	5.0	60	0.5	0.1	7.0
VDZ 11B	10.760	11.220	5.0	30	5.0	60	0.5	0.1	8.0
VDZ 12B	11.740	12.240	5.0	30	5.0	80	0.5	0.1	9.0
VDZ 13B	12.910	13.490	5.0	37	5.0	80	0.5	0.1	10.0
VDZ 15B	14.340	14.980	5.0	42	5.0	80	0.5	0.1	11.0
VDZ 16B	15.850	16.510	5.0	50	5.0	80	0.5	0.1	12.0
VDZ 18B	17.560	18.350	2.0	65	2.0	80	0.5	0.1	13.0
VDZ 20B	19.520	20.390	2.0	85	2.0	100	0.5	0.1	15.0
VDZ 22B	21.540	22.470	2.0	100	2.0	100	0.5	0.1	17.0
VDZ 24B	23.720	24.780	2.0	120	2.0	120	0.5	0.1	19.0
VDZ 27B	26.190	27.530	2.0	150	2.0	150	0.5	0.1	21.0
VDZ 30B	29.190	30.690	2.0	200	2.0	200	0.5	0.1	23.0
VDZ 33B	32.150	33.790	2.0	250	2.0	250	0.5	0.1	25.0
VDZ 36B	35.070	36.870	2.0	300	2.0	300	0.5	0.1	27.0

(1) The zener voltage(Vz) is measured 40ms after power is supplied.

(2) The operating resistances(Zz,Zzk) are measured by superimposing a minute alternating current on the regulated current(Iz)

●Type No.

TYPE	TYPE NO.	TYPE	TYPE NO.
VDZ 3.6B	62	VDZ 12B	25
VDZ 3.9B	72	VDZ 13B	35
VDZ 4.3B	82	VDZ 15B	45
VDZ 4.7B	92	VDZ 16B	55
VDZ 5.1B	A2	VDZ 18B	65
VDZ 5.6B	C2	VDZ 20B	75
VDZ 6.2B	E2	VDZ 22B	85
VDZ 6.8B	F2	VDZ 24B	95
VDZ 7.5B	H2	VDZ 27B	A5
VDZ 8.2B	J2	VDZ 30B	C5
VDZ 9.1B	L2	VDZ 33B	E5
VDZ 10B	05	VDZ 36B	F5
VDZ 11B	15		

Diodes

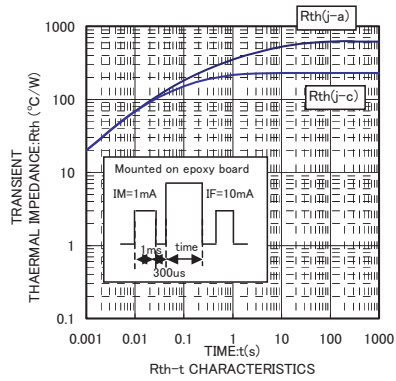
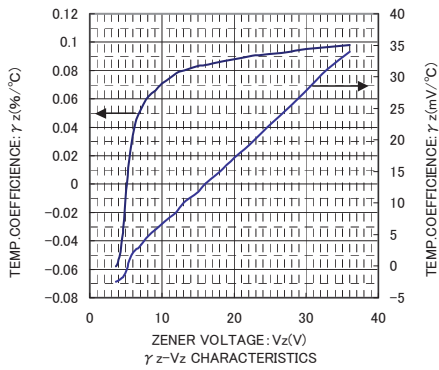
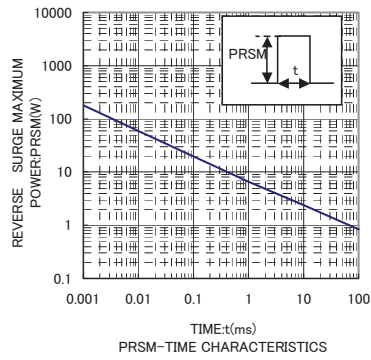
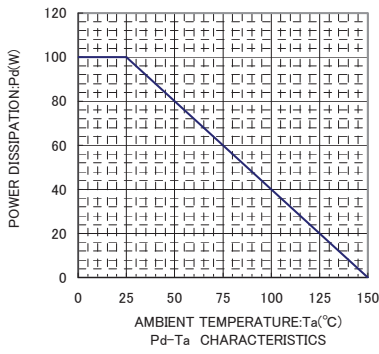
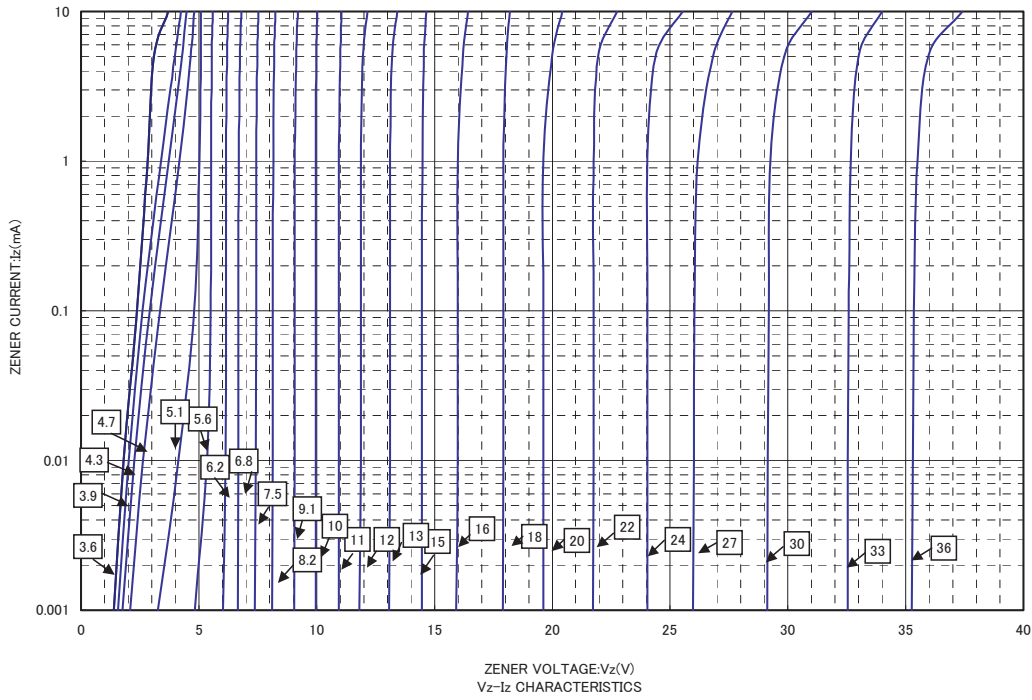

Diodes

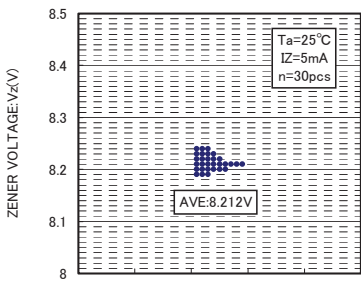
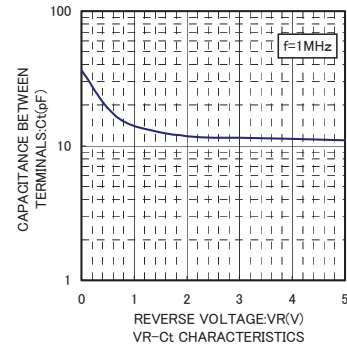
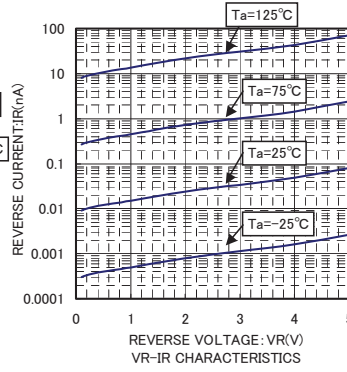
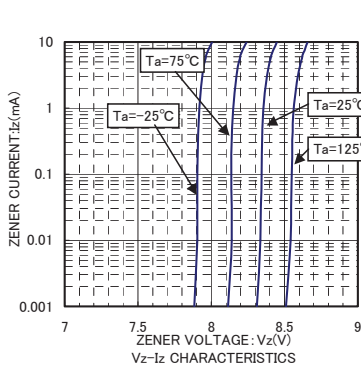

V_Z DISPERSION MAP

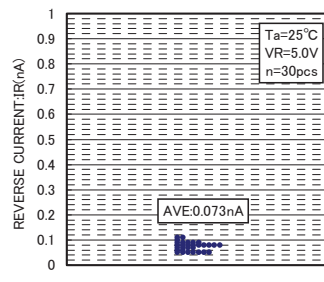

I_R DISPERSION MAP

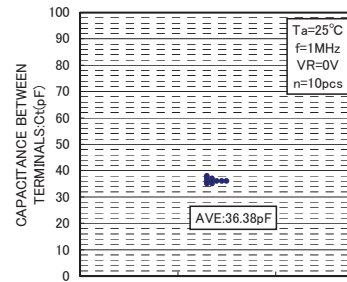

C_t DISPERSION MAP

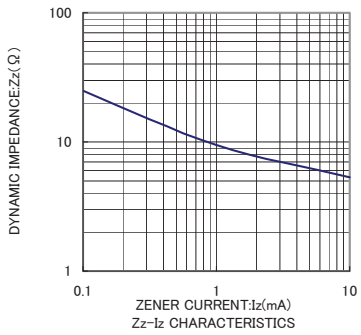

Notes

- No technical content pages of this document may be reproduced in any form or transmitted by any means without prior permission of ROHM CO.,LTD.
- The contents described herein are subject to change without notice. The specifications for the product described in this document are for reference only. Upon actual use, therefore, please request that specifications to be separately delivered.
- Application circuit diagrams and circuit constants contained herein are shown as examples of standard use and operation. Please pay careful attention to the peripheral conditions when designing circuits and deciding upon circuit constants in the set.
- Any data, including, but not limited to application circuit diagrams information, described herein are intended only as illustrations of such devices and not as the specifications for such devices. ROHM CO.,LTD. disclaims any warranty that any use of such devices shall be free from infringement of any third party's intellectual property rights or other proprietary rights, and further, assumes no liability of whatsoever nature in the event of any such infringement, or arising from or connected with or related to the use of such devices.
- Upon the sale of any such devices, other than for buyer's right to use such devices itself, resell or otherwise dispose of the same, no express or implied right or license to practice or commercially exploit any intellectual property rights or other proprietary rights owned or controlled by
- ROHM CO., LTD. is granted to any such buyer.
- Products listed in this document are no antiradiation design.

The products listed in this document are designed to be used with ordinary electronic equipment or devices (such as audio visual equipment, office-automation equipment, communications devices, electrical appliances and electronic toys).

Should you intend to use these products with equipment or devices which require an extremely high level of reliability and the malfunction of which would directly endanger human life (such as medical instruments, transportation equipment, aerospace machinery, nuclear-reactor controllers, fuel controllers and other safety devices), please be sure to consult with our sales representative in advance.

It is our top priority to supply products with the utmost quality and reliability. However, there is always a chance of failure due to unexpected factors. Therefore, please take into account the derating characteristics and allow for sufficient safety features, such as extra margin, anti-flammability, and fail-safe measures when designing in order to prevent possible accidents that may result in bodily harm or fire caused by component failure. ROHM cannot be held responsible for any damages arising from the use of the products under conditions out of the range of the specifications or due to non-compliance with the NOTES specified in this catalog.

Thank you for your accessing to ROHM product informations.

More detail product informations and catalogs are available, please contact your nearest sales office.

ROHM Customer Support System

THE AMERICAS / EUROPE / ASIA / JAPAN

www.rohm.com

Contact us : webmaster@rohm.co.jp