



## ULTRA COMPACT CHIP ANTENNAS DATA GUIDE

### DESCRIPTION

The exciting ANT-\*\*\*-CHP family is among the world's smallest high-performance Chip Antennas. They are ideal for embedding in wireless products including Bluetooth, 802.11, Home RF, ZigBee and other popular standards. These tiny antennas use advanced Low Temperature Co-fired Ceramic (LTCC) technology and proprietary elements to achieve superior size and performance characteristics. The entire family is compatible with hand- and reflow-assembly. Excellent electrical specifications, stability, and outstanding cost-effectiveness make CHP Series antennas the logical choice for a wide variety of applications.

### FEATURES

- Incredibly compact SMD package
- Superior LTCC technology
- 50Ω characteristic impedance
- Low loss
- Wide bandwidth
- Favorable linear polarization
- > Unity gain
- No external matching required
- Highly stable over temperature & time
- Hand- and reflow-assembly compatible
- RoHS compliant
- Cost-effective

### APPLICATIONS

- Bluetooth
- 802.11
- ZigBee
- Wireless PCMCIA Cards
- Telemetry
- Data Collection
- Industrial Process Monitoring
- Compact Wireless Products
- External Antenna Elimination

### PHYSICAL DIMENSIONS

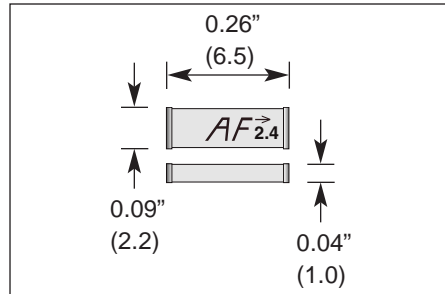

2.45GHz Version

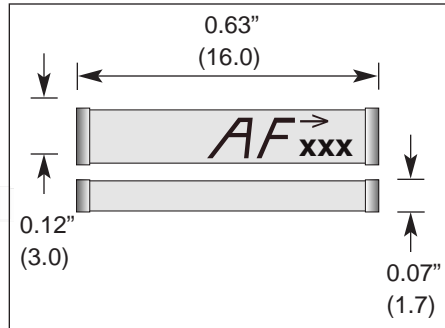

868 / 916MHz Versions

### ACTUAL SIZE

2.45GHz



### ORDERING INFORMATION

PART #	DESCRIPTION
ANT-868-CHP-x	868MHz Chip Antenna
ANT-916-CHP-x	916MHz Chip Antenna
ANT-2.45-CHP-x	2.45GHz Chip Antenna

x = "T" for Tape/Reel, "B" for Bulk

All parts are RoHS compliant.  
Standard Reel is 3,000 pcs.  
Quantities less than 3,000 pcs. are supplied in bulk.

## SPECIFICATIONS

### PHYSICAL SPECIFICATIONS

	2.45GHz	868MHz	916MHz
Dimensions (mm)	6.5(L) x 2.2(W) x 1.0(H)	16.0(L) x 3.0(W) x 1.7(H)	16.0(L) x 3.0(W) x 1.7(H)
Operating/Storage Temp	-40 ~ +85°C	-40 ~ +85°C	-40 ~ +85°C
Construction	LTCC	LTCC	LTCC

### ELECTRICAL PERFORMANCE

	2.45GHz	868MHz	916MHz
Center Frequency	2.45GHz	868MHz	916MHz
Bandwidth	180MHz	10MHz	10MHz
Wavelength	1/4-wave	1/4-wave	1/4-wave
Pattern	Omni-directional	Omni-directional	Omni-directional
Polarization	Linear	Linear	Linear
VSWR	≤2.0 (Max.)	≤2.0 (Max.)	≤2.0 (Max.)
Maximum Gain	+0.5dBi	+0.5dBi	+0.5dBi
Impedance	50Ω	50Ω	50Ω
Power Handling	3W (Max.)	3W (Max.)	3W (Max.)

### 2.4GHz FOOTPRINT

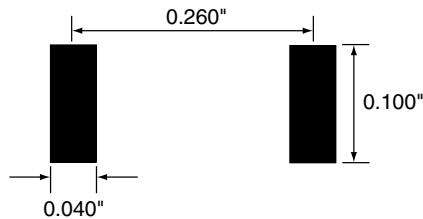

### 868 & 916MHz FOOTPRINT

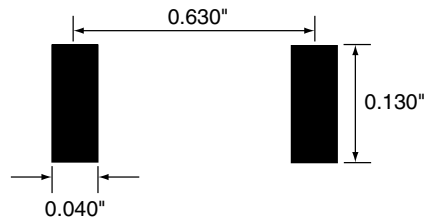

### PIN CONFIGURATION

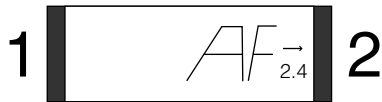

Pin Number	Pin Description
1	Feed Termination This pin connects to the transmitter or receiver
2	Solder Termination This pin is for physical support only. There is no electrical connection

## THEORY OF OPERATION

The CHP Series antennas utilize Low Temperature Cofired Ceramic (LTCC) technology to embed the antenna element into a ceramic substrate. Advances in this technology have resulted in materials that are extremely stable over time and temperature, producing an antenna that is highly reliable across a wide range of applications. The high-frequency characteristics of this technology enable exceptional performance in a very small package. The construction techniques for LTCC devices lends itself well to favorable pricing in high volume.

## LAYOUT CONSIDERATIONS

Proper layout is vital to ensure correct operation and optimum performance. Improper placement of planes, traces, or system components will result in nulls or complete de-tuning. Ideally, the antenna will be mounted on the board in such a way as to allow an unobstructed field of view. The area underneath the antenna must be free of components, traces, and planes. Components may be placed to the rear of the antenna in the ground plane counterpoise area. The feed trace from the RF stage to the antenna must be a microstrip trace or coax transmission line and should be kept as short as practical.

The layout of our reference jigs is illustrated on the following pages. While they demonstrate various aspects of a layout, it is not necessary to replicate them exactly. While your board size and layout may differ, it is important to recognize that the counterpoise plays an important role in resonance and stability since it acts, in essence, as part of the antenna. After your own layout is complete, the performance of the antenna in your specific product should be carefully checked using tools like a network analyzer. In some cases, the size of the product's PCB, proximity of the case, or other factors may make a custom version of the antenna necessary. Contact Antenna Factor for more information.

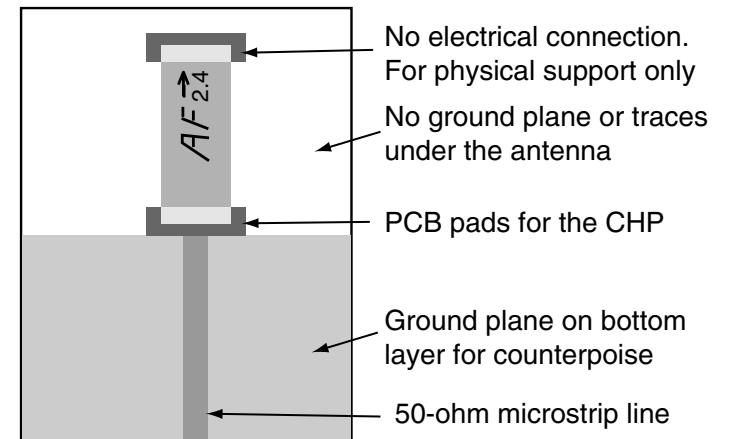

## MICROSTRIP DETAILS

A transmission line is a medium whereby RF energy is transferred from one place to another with minimal loss. This is a critical factor, especially in high-frequency products, because the trace leading to the antenna can effectively contribute to the length of the antenna, changing its resonant bandwidth. In order to minimize loss and detuning, some form of transmission line between the antenna and the RF stage should be used, unless the antenna can be placed very close (<1/8in.) to the RF stage. One common form of transmission line is a coax cable, another is the microstrip. This term refers to a PCB trace running over a ground plane that is designed to serve as a transmission line between the RF stage and the antenna. The width is based on the desired characteristic impedance of the line, the thickness of the PCB, and the dielectric constant of the board material. For standard 0.062in-thick FR-4 board material, the trace width would be 111 mils. The correct trace width can be calculated for other widths and materials using the information below. Handy software for calculating microstrip lines is also available on the Antenna Factor website, [www.antennafactor.com](http://www.antennafactor.com).

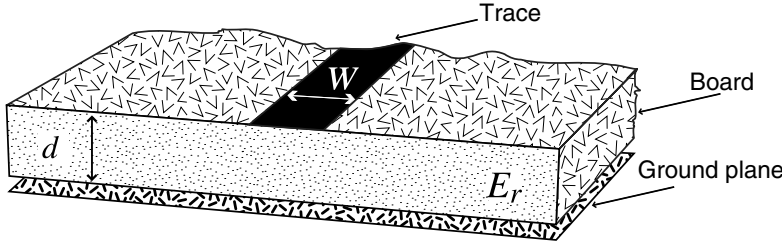

$$E_e = \frac{E_r + 1}{2} + \frac{E_r - 1}{2} \cdot \frac{1}{\sqrt{1 + 12d/W}}$$

$$Z_0 = \begin{cases} \frac{60}{\sqrt{E_e}} \cdot \ln\left(\frac{8d}{W} + \frac{W}{4d}\right) & \text{For } \frac{W}{d} \leq 1 \\ \frac{120\pi}{\sqrt{E_e} \cdot \left(\frac{W}{d} + 1.393 + 0.667 \cdot \ln\left(\frac{W}{d} + 1.444\right)\right)} & \text{For } \frac{W}{d} \geq 1 \end{cases}$$

$E_r$  = Dielectric constant of PCB material

Dielectric Constant	Width/Height (W/d)	Effective Dielectric Constant	Characteristic Impedance
4.80	1.8	3.59	50.0
4.00	2.0	3.07	51.0
2.55	3.0	2.12	48.0

## ASSEMBLY CONSIDERATIONS

The antenna is RoHS Compliant and designed to support hand or automated assembly. To avoid damage to the part, the reflow solder guidelines found below should be carefully followed. The antenna is single ended meaning that one pad is electrically connected while the other is for mechanical support only. The antenna terminals are not interchangeable so polarity must be observed during assembly.

### Hand Soldering

This antenna is designed for high-volume automated assembly, however, it may be successfully attached by hand assembly techniques. A hand-solder temperature of 225° or lower should be used. Do not exceed a 10 sec. heating time.

### Reflow Temperature Profile

The single most critical stage in the automated assembly process is the reflow process. The reflow profile below should be closely followed since excessive temperatures or transport times during reflow will irreparably damage the antennas. Assembly personnel will need to pay careful attention to the oven's profile to ensure that it meets the requirements necessary to successfully reflow all components while still meeting the limits mandated by the antennas themselves.

### MAXIMUM REFLOW SOLDERING PROFILE

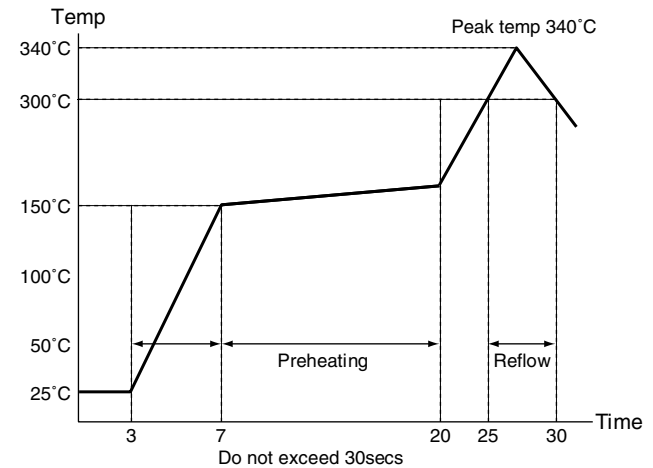

### Absolute Maximum Solder Times

Hand-Solder Temp. TX +225°C for 10 Sec.  
 Hand-Solder Temp. RX +225°C for 10 Sec.  
 Recommended Solder Melting Point +180°C  
 Reflow Oven: +340°C Max. (See adjoining diagram)

## 2.4GHZ TEST BOARD

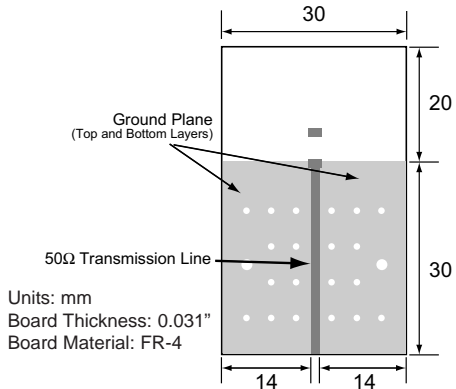

## 2.4GHz TYPICAL VSWR

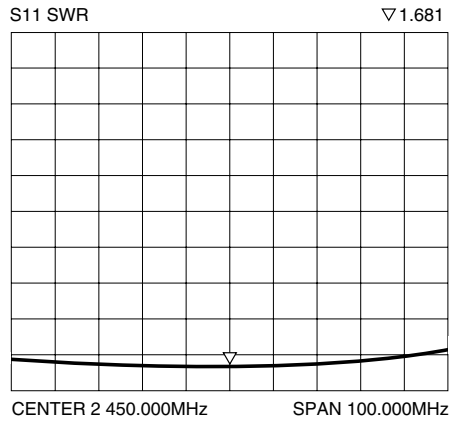

## 2.4GHz PATTERN TEST

### 2.45GHz H-Plane Vertical

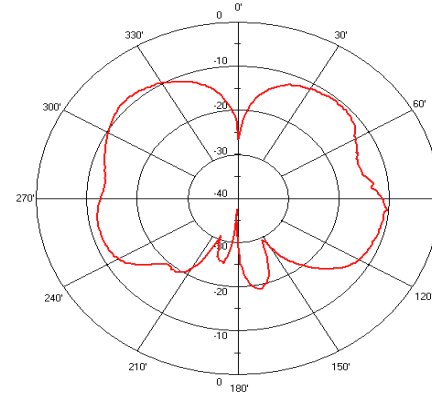

### 2.45GHz H-Plane Horizontal

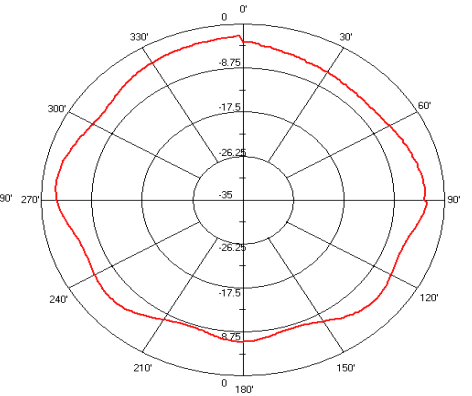

## 868 & 916MHz TEST BOARD

Board Thickness: 0.062"  
Board Material: FR-4

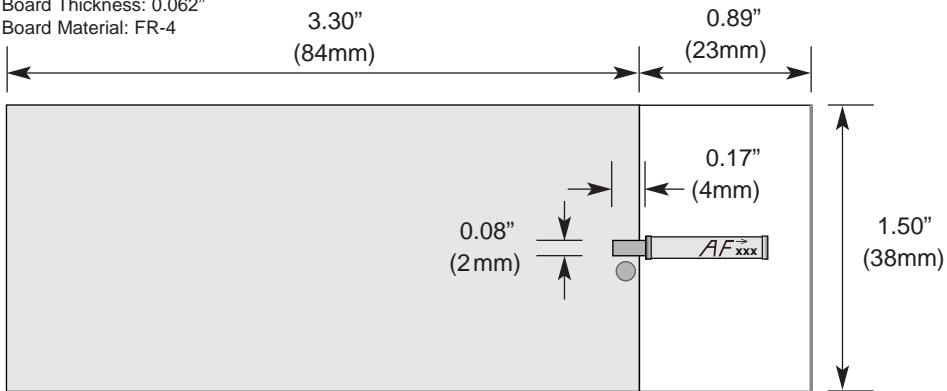

## 868MHz TYPICAL VSWR

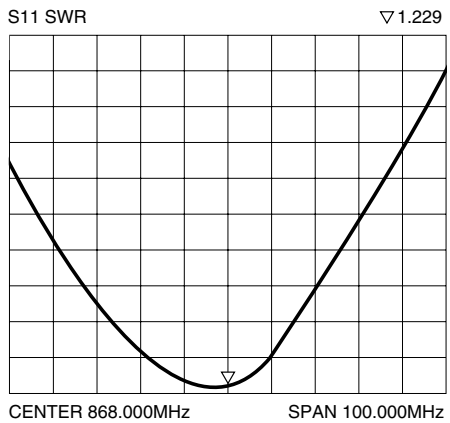

## 916MHz TYPICAL VSWR

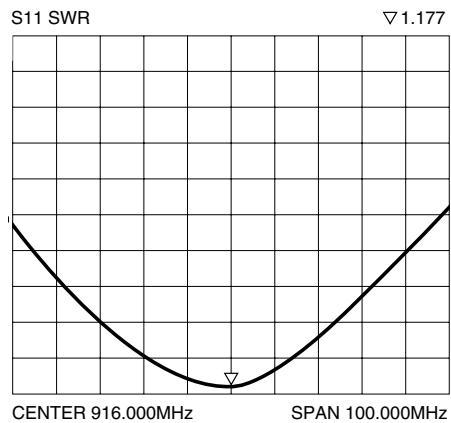

### 2.45GHz E-Plane Vertical

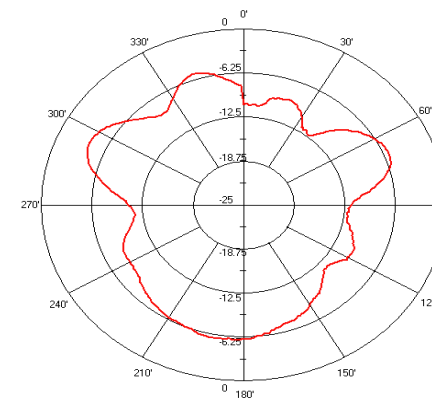

### 2.45GHz E-Plane Horizontal

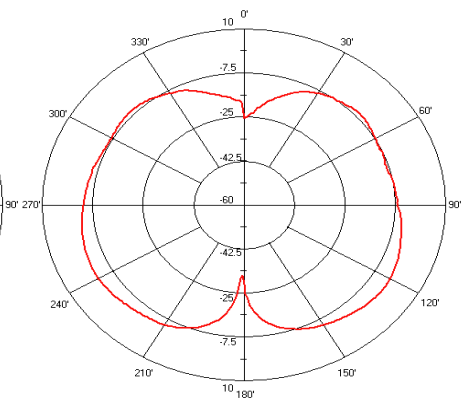

868MHz H-Plane  
Vertical

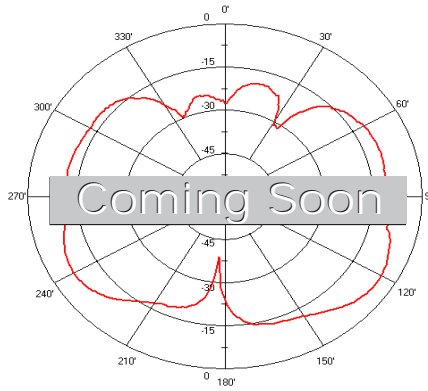

868MHz H-Plane  
Horizontal



868MHz E-Plane  
Vertical

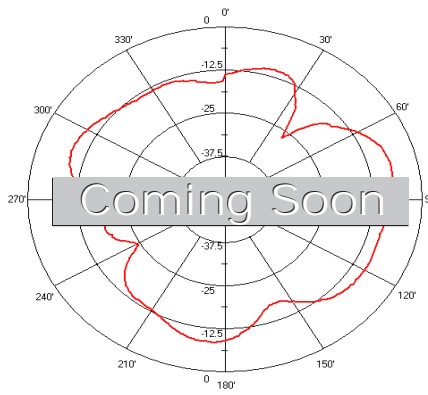

868MHz E-Plane  
Horizontal



916MHz H-Plane  
Vertical

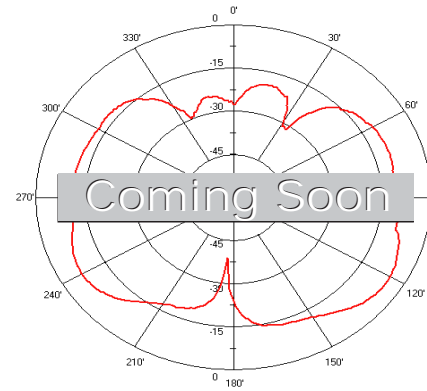

916MHz H-Plane  
Horizontal

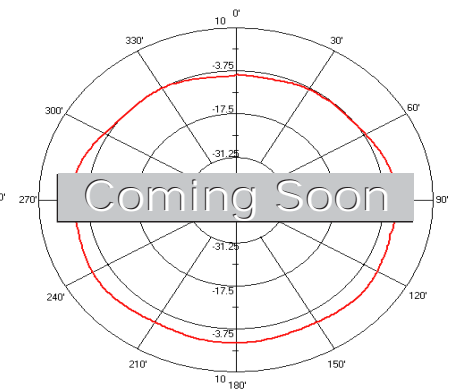

916MHz E-Plane  
Vertical

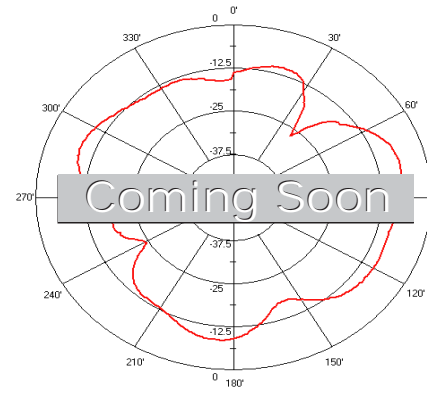

916MHz E-Plane  
Horizontal

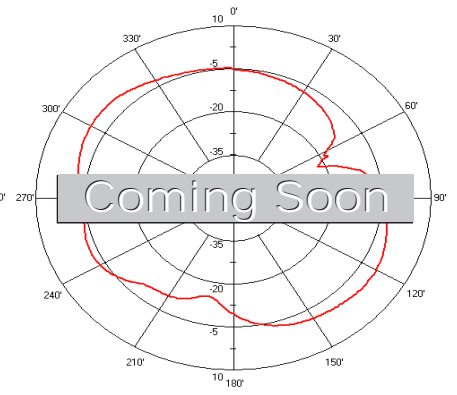

## MISMATCH CONVERSION TABLE

VSWR	Insertion Loss (dB)	Power Transmtd (%)	Power Reflected (%)
17.391	-6.87	20.57%	79.43%
11.610	-5.35	29.21%	70.79%
8.724	-4.33	36.90%	63.10%
6.997	-3.59	43.77%	56.23%
5.848	-3.02	49.88%	50.12%
5.030	-2.57	55.33%	44.67%
4.419	-2.20	60.19%	39.81%
3.946	-1.90	64.52%	35.48%
3.570	-1.65	68.38%	31.62%
3.010	-1.26	74.88%	25.12%
2.615	-0.97	80.05%	19.95%
2.323	-0.75	84.15%	15.85%
2.100	-0.58	87.41%	12.59%
1.925	-0.46	90.00%	10.00%
1.433	-0.14	96.84%	3.16%
1.222	-0.04	99.00%	1.00%
1.119	-0.01	99.68%	0.32%
1.065	0.00	99.90%	0.10%
1.034	0.00	99.97%	0.03%
1.020	0.00	99.99%	0.01%

## ON-LINE RESOURCES



[www.antennafactor.com](http://www.antennafactor.com)

- Latest News
- Data Guides
- Application Notes
- Knowledge Base
- Custom Antennas



The Antenna Factor division of Linx offers a diverse array of antenna styles, many of which are optimized for use with our RF modules. From innovative embeddable antennas to low-cost whips, domes to Yagi's, and even GPS, it is likely that Antenna Factor has an antenna to meet your requirements or can assist you with a custom antenna tailored to your needs. Day or night, our corporate website provides a ready resource for the latest information and support of our many products.



[www.connectorcity.com](http://www.connectorcity.com)

Through its Connector City division, Linx offers a wide selection of high-quality RF connectors, including FCC-compliant types such as RP-SMA that are an ideal match for our modules and antennas. Connector City focuses on high-volume OEM requirements, which allows standard and custom RF connectors to be offered at a remarkably low cost.



[www.linxtechnologies.com](http://www.linxtechnologies.com)

If you have questions regarding any Linx product and have Internet access, make [www.linxtechnologies.com](http://www.linxtechnologies.com) your first stop. Our website is organized in an intuitive format to immediately give you the answers you need.





## U.S. CORPORATE HEADQUARTERS

### ***ANTENNA FACTOR, INC.***

575 SE ASHLEY PLACE  
GRANTS PASS, OR 97526

Phone: (541) 956-0931

Fax: (541) 471-6251

[www.antennafactor.com](http://www.antennafactor.com)

## **Disclaimer**

---

Antenna Factor is continually striving to improve the quality and function of its products; for this reason, we reserve the right to make changes without notice. The information contained in this Data Guide is believed to be accurate as of the time of publication. Specifications are based on representative lot samples. Values may vary from lot to lot and are not guaranteed. Antenna Factor makes no guarantee, warranty, or representation regarding the suitability of any product for use in a specific application. None of these devices is intended for use in applications of a critical nature where the safety of life or property is at risk. The user assumes full liability for the use of product in such applications. Under no conditions will Antenna Factor be responsible for losses arising from the use or failure of the device in any application, other than the repair, replacement, or refund limited to the original product purchase price. Some devices described in this publication are patented. Under no circumstances shall any user be conveyed any license or right to the use or ownership of these patents.

---

© 2006 by Antenna Factor, Inc. The stylized Antenna Factor logo, and Antenna Factor are trademarks of Linx Technologies, Inc.  
Printed in U.S.A.