

## Product Description

Sirenza Microdevices' SZA-3044 is a high linearity class AB Heterojunction Bipolar Transistor (HBT) amplifier housed in a low-cost surface-mountable plastic package. This HBT amplifier is made with InGaP on GaAs device technology and fabricated with MOCVD for an ideal combination of low cost and high reliability. This product is specifically designed as a final or driver stage for 802.16 equipment in the 3.3-3.8 GHz bands. It can run from a 3V to 6V supply. Optimized on-chip impedance matching circuitry provides a 50Ω nominal RF input impedance. The external output match and bias adjustability allows load line optimization for other applications or over narrower bands. It features an output power detector, on/off power control and high RF overdrive robustness. This product is available in a RoHS Compliant and Green package with matte tin finish, designated by the "Z" package suffix.

### Functional Block Diagram

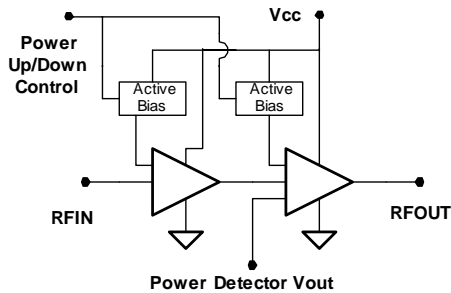

## SZA-3044 SZA-3044Z



2.7-3.8GHz 5V 1W Power Amplifier



4mm x 4mm QFN Package

### Product Features

- P1dB = 31dBm @ 5V
- 802.11a 54Mb/s 2.5% EVM Performance
  - Pout = 24dBm, Vcc=5V, 340mA, PAE 14.5%
  - Pout = 25dBm, Vcc=6V, 365mA, PAE 14.5%
- On-chip Output Power Detector
- Robust - Survives RF Input Power = +15dBm
- On Chip ESD Protection Class 2 (2000V)
- Power up/down control < 1μs
- Pin compatible with SZA-2044 and SZA-5044

### Applications

- 802.16 WiMAX Driver or Output Stage
- Fixed Wireless, WLL

### Key Specifications

Symbol	Parameters: Test Conditions, App circuit page 6 Z <sub>0</sub> = 50Ω, V <sub>CC</sub> = 5.0V, I <sub>q</sub> = 205mA, T <sub>BP</sub> = 30°C	Unit	Min.	Typ.	Max.
f <sub>O</sub>	Frequency of Operation	MHz	2700		3800
P <sub>1dB</sub>	Output Power at 1dB Compression – 3.3GHz	dBm	29.5	31.0	
	Output Power at 1dB Compression – 3.6GHz		28.5	30.0	
S <sub>21</sub>	Small Signal Gain – 3.4GHz	dB	22	24	26
	Small Signal Gain – 3.6GHz		22	24	26
P <sub>out</sub>	Output power at 2.5% EVM 802.11a 54Mb/s - 3.4GHz	dBm		24	
IM3	Third Order Suppression (P <sub>out</sub> =20dBm per tone) - 3.6GHz	dBc		-38.5	-35.5
NF	Noise Figure at 3.6 GHz	dB		5.0	
IRL	Worst Case Input Return Loss 3.3-3.8GHz	dB	12	15	
ORL	Worst Case Output Return Loss 3.3-3.6GHz		7	10	
V <sub>det</sub> Range	Output Voltage Range for P <sub>out</sub> =+15dBm to +30dBm	V		0.9 to 2.1	
I <sub>cq</sub>	Quiescent Current (V <sub>cc</sub> = 5V)	mA	170	205	240
I <sub>VPC</sub>	Power Up Control Current, V <sub>pc</sub> =5V, ( I <sub>VPC1</sub> + I <sub>VPC2</sub> )	mA		2.7	
I <sub>LEAK</sub>	Off Vcc Leakage Current V <sub>pc</sub> =0V	uA		10	100
R <sub>th, j-l</sub>	Thermal Resistance (junction - lead)	°C/W		22	

## Pin Out Description

Pin #	Function	Description
1,2,4,5,7,9,11,13,15,17,19	N/C	These are unused pins and not wired inside the package. They may be grounded or connected to adjacent pins.
6	VPC1	VPC1 is the bias control pin for the stage 1 active bias circuit. An external series resistor is required for proper setting of bias levels. Refer to the evaluation board schematic for resistor value. To prevent potential damage, do not apply voltage to this pin that is +1V greater than voltage applied to pin 20 (Vbias) unless Vpc supply current capability is less than 10 mA.
8	VPC2	VPC2 is the bias control pin for the stage 2 active bias circuit. An external series resistor is required for proper setting of bias levels. Refer to the evaluation board schematic for resistor value. To prevent potential damage, do not apply voltage to this pin that is +1V greater than voltage applied to pin 20 (Vbias) unless Vpc supply current capability is less than 10 mA.
10	Vdet	Output power detector voltage. Load with > 10K ohms for best performance
3	RFIN	RF input pin. This is DC grounded internal to the IC. Do not apply voltage to this pin.
12,14	RFOUT	RF output pin. This is also another connection to the 2nd stage collector.
16	VC2	2nd stage collector bias pin. Apply 3.0 to 5.0V to this pin.
18	VC1	1st stage collector bias pin. Apply 3.0 to 5.0V to this pin.
20	Vbias	Active bias network VCC. Apply 3.0 to 5.0V to this pin.
EPAD	Gnd	Exposed area on the bottom side of the package needs to be soldered to the ground plane of the board for optimum thermal and RF performance. Several vias should be located under the EPAD as shown in the recommended land pattern (page 5).

## Simplified Device Schematic

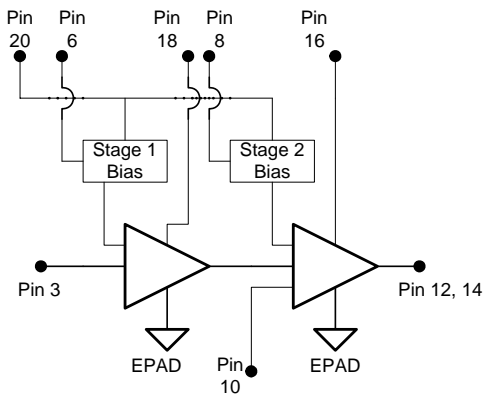

### Caution: ESD Sensitive

Appropriate precaution in handling, packaging and testing devices must be observed.

## Absolute Maximum Ratings

Parameters	Value	Unit
VC2 Collector Bias Current ( $I_{VC2}$ )	600	mA
VC1 Collector Bias Current ( $I_{VC1}$ )	300	mA
Device Voltage ( $V_D$ )	7.0	V
Power Dissipation	3.5	W
Operating Lead Temperature ( $T_L$ )	-40 to +85	°C
Max RF Input Power for 50 ohm output load	15	dBm
Max RF Input Power for 10:1 VSWR RF out load	8	dBm
Storage Temperature Range	-40 to +150	°C
Operating Junction Temperature ( $T_J$ )	+150	°C
ESD Human Body Model	2000	V

Operation of this device beyond any one of these limits may cause permanent damage. For reliable continuous operation the device voltage and current must not exceed the maximum operating values specified in the table on page one.

Bias conditions should also satisfy the following expression:  

$$I_D V_D < (T_J - T_L) / R_{TH} j-I$$

**Typical Performance, 3.2-3.6GHz Application Circuit (Vcc=5V, Icq=220mA, 802.11a 54Mb/s 64QAM)\***

Parameter	Units	3.2GHz	3.3GHz	3.4GHz	3.5GHz	3.6GHz	3.7GHz	
Gain @ Pout=24dBm	dB	25.7	25.6	25.5	25.2	24.3	23.4	-
P1dB	dBm	31.0	31.0	30.5	30.0	30.0	29.5	-
Pout @ 2.5% EVM*	dBm	23.5	24.0	24.0	23.5	23.0	23.0	-
I @ Pout 2.5% EVM*	mA	331	340	339	330	327	325	-

\* See 3.0-3.6GHz Application Circuit, pg. 7.

**Typical Performance, 3.2-3.6GHz 6V Application Circuit (Vcc=6V, Icq=220mA, 802.11a 54Mb/s 64QAM)\***

Parameter	Units		3.3GHz	3.4GHz	3.5GHz	3.6GHz	3.7GHz	
Gain @ Pout=24dBm	dB	-	25.6	25.6	25.1	24.1	23.2	-
P1dB	dBm	-	32.5	32.0	32.0	31.5	31.5	-
Pout @ 2.5% EVM*	dBm	-	25	25	25	24.5	24.5	-
I @ Pout 2.5% EVM*	mA	-	370	365	363	356	355	-

\* Contact Applications Engineering for details about application circuit.

**Typical Performance, 3.4-3.7GHz Application Circuit (Vcc=5V, Icq=360mA, 802.11a 54Mb/s 64QAM)\***

Parameter	Units			3.4GHz	3.5GHz	3.6GHz	3.7GHz	3.8GHz
Gain @ Pout=24dBm	dB	-	-	24.5	24.2	23.6	22.7	21.5
P1dB	dBm	-	-	31.5	31.5	31.0	31.0	30.0
Pout @ 2.5% EVM*	dBm	-	-	23.5	23.5	24.0	23.5	23.0
I @ Pout 2.5% EVM*	mA	-	-	445	450	450	450	433

\* Optimized for maximum Pout @ 2.5% EVM over 3.4-3.7GHz band. Same application circuit from Rev. B datasheet. Contact Applications Engineering for details.

**Typical Performance, 2.7-3.0GHz Application Circuit (Vcc=5V, Icq=360mA, 802.11a 54Mb/s 64QAM)\***

Parameter	Units	2.7GHz	2.8GHz	2.9GHz	3.0GHz			
Gain @ Pout=24dBm	dB	25.3	25.3	25.3	25.2	-	-	-
P1dB	dBm	31	31	31	31	-	-	-
Pout @ 2.5% EVM*	dBm	23	23.5	23.5	23.5	-	-	-
I @ Pout 2.5% EVM*	mA	438	453	450	444	-	-	-

\* Contact Applications Engineering for details about application circuit.

Measured 3.2 - 3.6 GHz Application Circuit Data ( $V_{CC} = V_{PC} = 5.0V$ ,  $I_Q = 220mA$ ,  $T=25C$ )

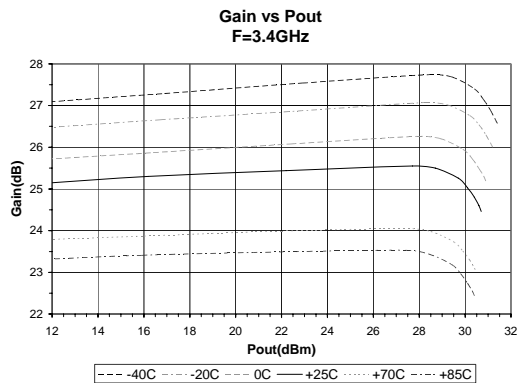
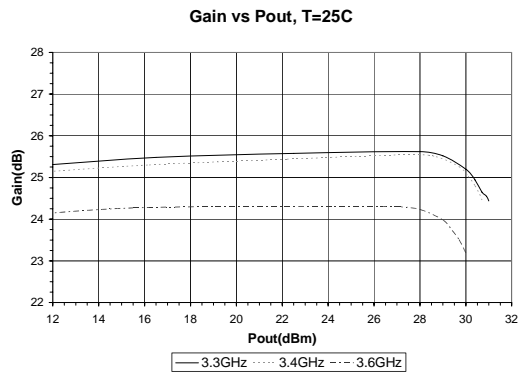
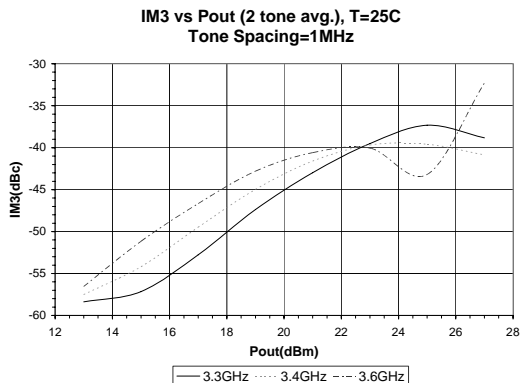
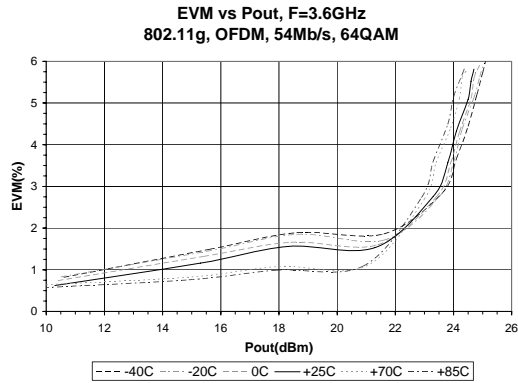
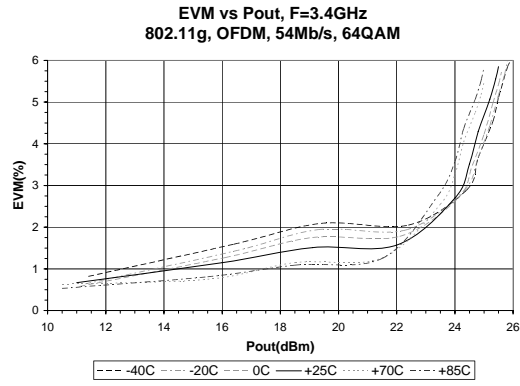
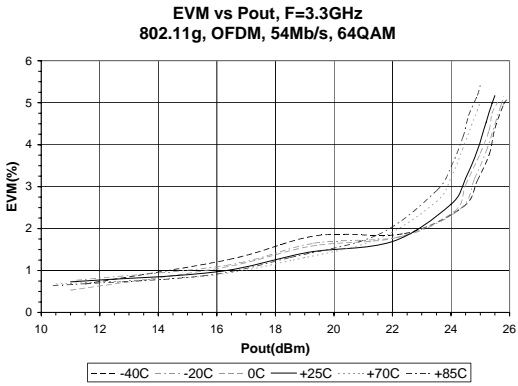

Measured 3.2 - 3.6 GHz Application Circuit Data ( $V_{CC} = V_{PC} = 5.0V$ ,  $I_q = 220mA$ ,  $T=25C$ )

Narrowband S11 - Input Return Loss

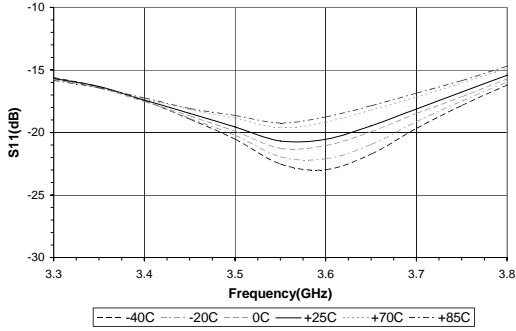

Narrowband S12 - Reverse Isolation

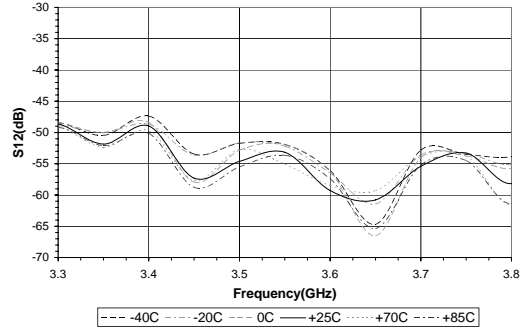

Narrowband S21 - Forward Gain

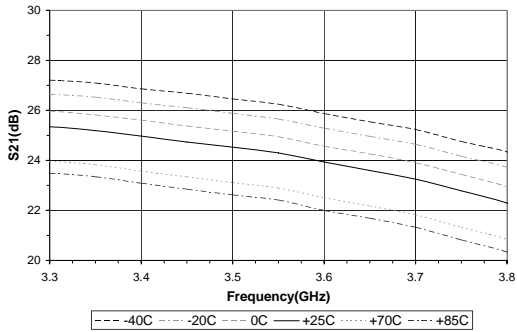

Narrowband S22 - Output Return Loss

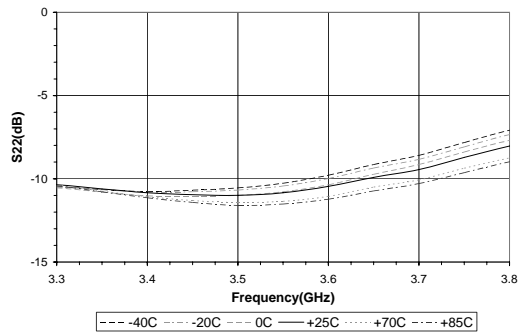

DC Supply Current ( $I_{dc}$ ) vs  $P_{out}$ ,  $T=25C$

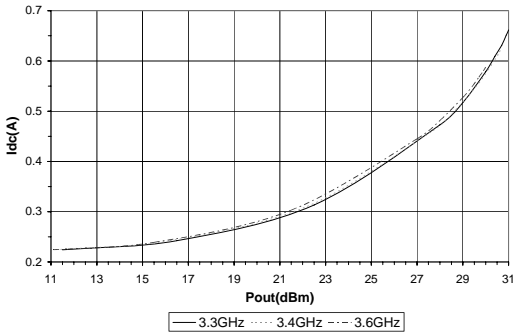

Noise Figure (NF) vs Frequency

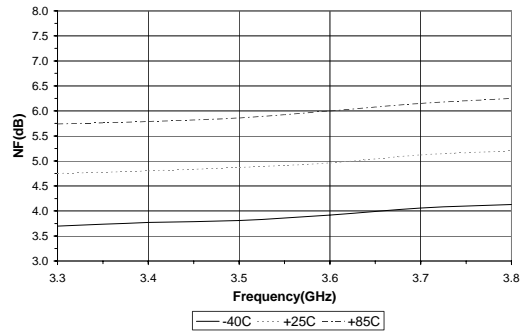

Measured 3.2 - 3.6 GHz Application Circuit Data ( $V_{CC} = V_{PC} = 5.0V$ ,  $I_q = 220mA$ ,  $T=25C$ )

RF Power Detector (Vdet) vs Pout, T=25C

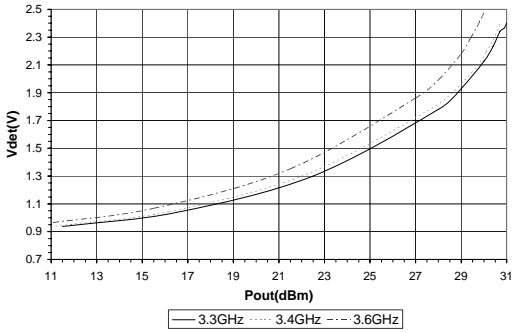

RF Power Detector (Vdet) vs Pout  
F=3.4GHz

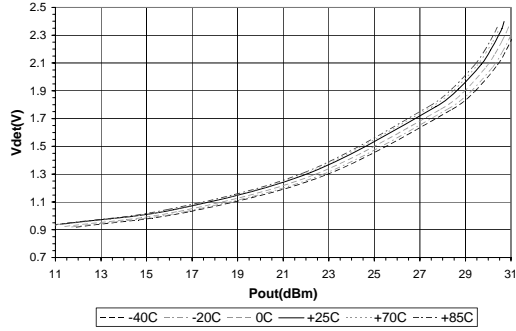

Broadband S11 - Input Return Loss

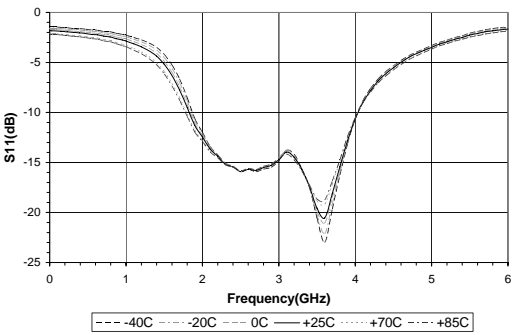

Broadband S12 - Reverse Isolation

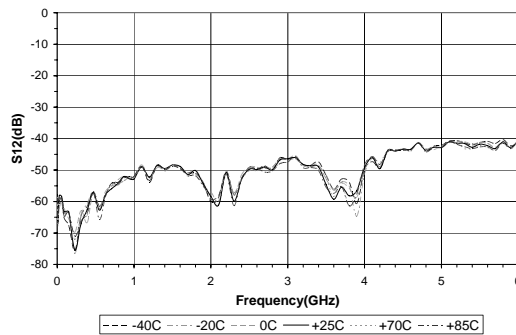

Broadband S21 - Forward Gain

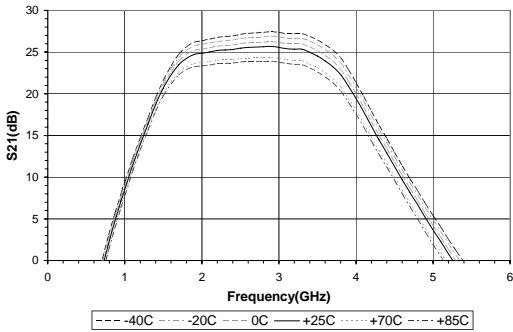

Broadband S22 - Output Return Loss

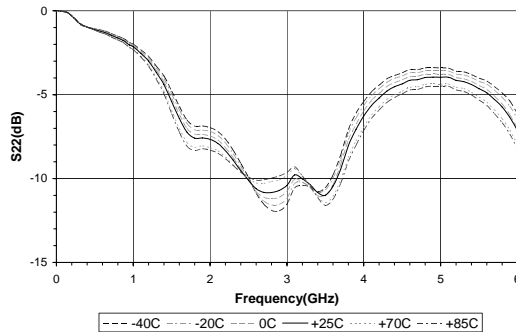

### 3.2-3.6 GHz Application Circuit For Vcc = V+ = Vpc = 5.0V

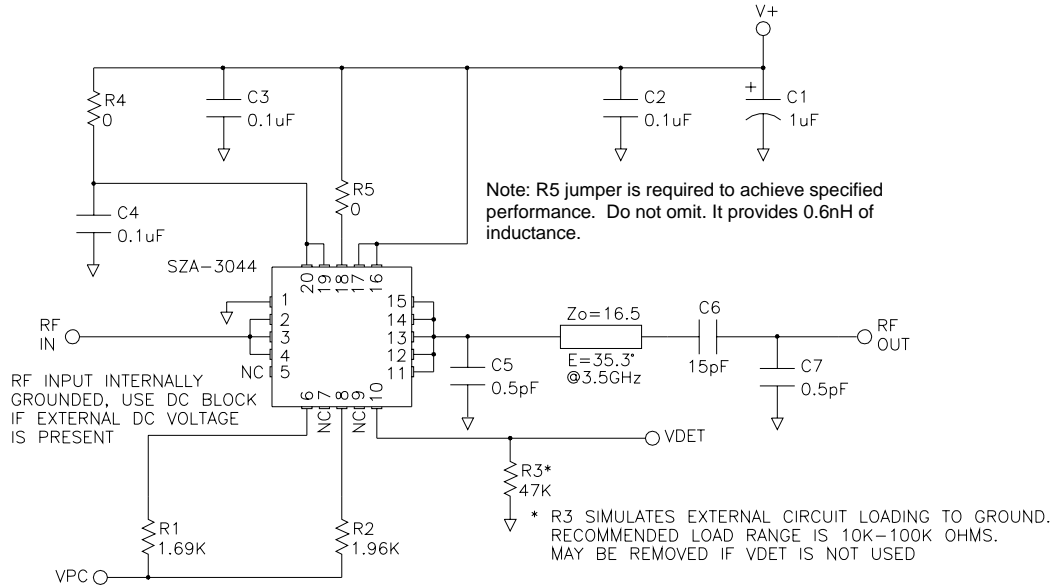

### 3.2-3.6 GHz Evaluation Board Layout For Vcc = V+ = Vpc = 5.0V

Board material GETEK, 10mil thick, Dk=3.9, 2 oz. copper

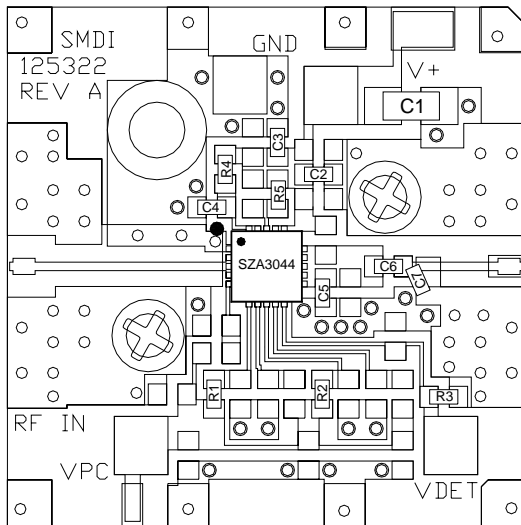

DESG	DESCRIPTION	NOTES
Q1	SZA-3044	4x4 QFN
R1	1.69K OHM, 0603 1%	0402 may be used instead
R2	1.96K OHM, 0603 1%	"
R3	47K OHM, 0603	"
R4,5	0 OHM, 0603	"
C1	1uF 16V CAP	Tantalum ok for EVM performance. Use MLCC type for best IM3 levels.
C2,3,4	0.1uF CAP, 0603	NPO type, 0402 ok ROHM MCH184CN105K or equiv.
C5	0.5pF CAP, 0603	NPO type ROHM MCH185A0R5CK or equiv.
C6	15pF CAP, 0603	NPO type ROHM MCH185A150JK or equiv.
C7	0.5pF CAP, 0603	NPO type ROHM MCH185A0R5CK or equiv.

## SZA-3044 2.7-3.8 GHz 5V Power Amp

### Part Symbolization

The part will be symbolized with an "SZA-3044" for Sn/Pb plating or "SZA-3044Z" for RoHS green compliant product. Marking designator will be on the top surface of the package.

### Part Number Ordering Information

Part Number	Reel Size	Devices/Reel
SZA-3044	13"	3000
SZA-3044Z	13"	3000

Package Outline Drawing (dimensions in mm): Refer to package outline drawing for more detail.

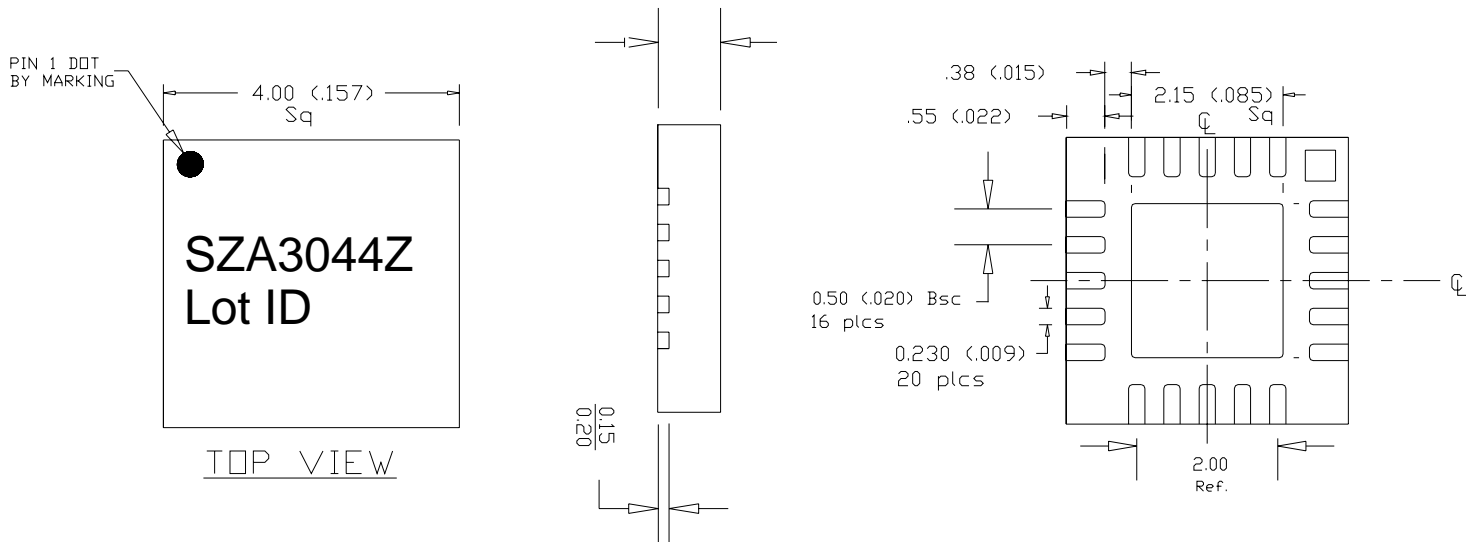

Recommended Land Pattern (dimensions in mm[in]):

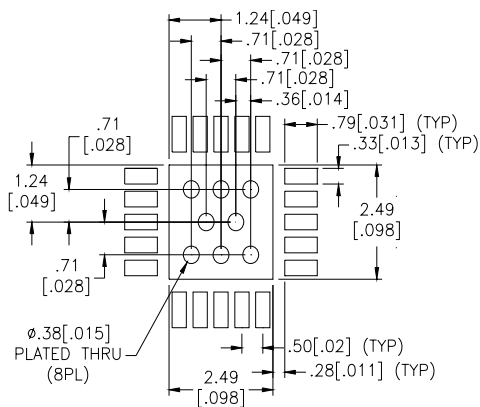

Recommended PCB Soldermask (SMOBC) for landing pattern (dimensions in mm[in]):

