

## 5 A - 1200 V - low drop internally clamped IGBT

### Features

- Low on-voltage drop ( $V_{CE(sat)}$ )
- High current capability
- Off losses include tail current
- High voltage clamping

### Applications

- Light dimmer
- Inrush current limitation
- Pre-heating for electronic lamp ballast

### Description

This IGBT utilizes the advanced Power MESH™ process resulting in an excellent trade-off between switching performance and low on-state behavior.

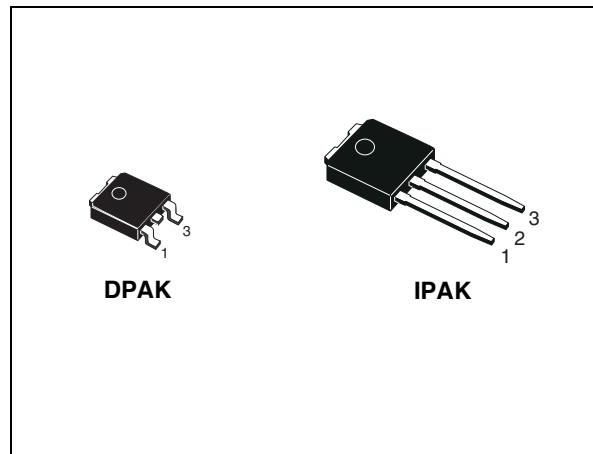

**Figure 1. Internal schematic diagram**

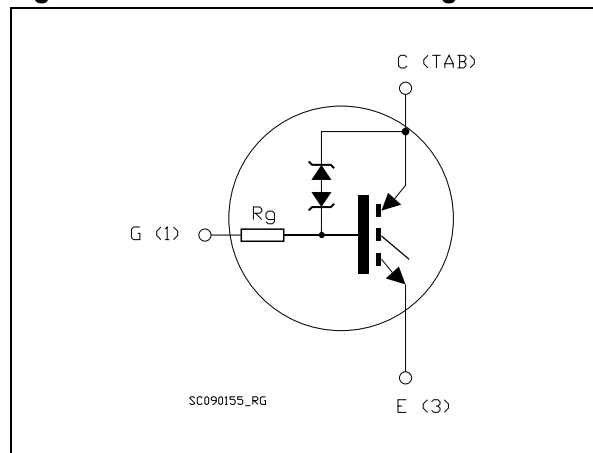

**Table 1. Device summary**

Order codes	Marking	Package	Packaging
STGD5NB120SZ-1	GD5NB120SZ	IPAK	Tube
STGD5NB120SZT4	GD5NB120SZ	DPAK	Tape and reel

## Contents

<b>1</b>	<b>Electrical ratings</b> .....	<b>3</b>
<b>2</b>	<b>Electrical characteristics</b> .....	<b>4</b>
	2.1 Electrical characteristics (curves) .....	6
<b>3</b>	<b>Test circuit</b> .....	<b>9</b>
<b>4</b>	<b>Package mechanical data</b> .....	<b>10</b>
<b>5</b>	<b>Packaging mechanical data</b> .....	<b>13</b>
<b>6</b>	<b>Revision history</b> .....	<b>14</b>

# 1 Electrical ratings

**Table 2. Absolute maximum ratings**

Symbol	Parameter	Value	Unit
$V_{CES}$	Collector-emitter voltage ( $V_{GE} = 0$ )	1200	V
$I_C^{(1)}$	Collector current (continuous) at $T_C = 25\text{ °C}$	10	A
$I_C^{(1)}$	Collector current (continuous) at $T_C = 100\text{ °C}$	5	A
$I_{CP}^{(2)}$	Pulsed collector current	10	A
$I_{CL}^{(3)}$	Turn-off latching current	10	A
$V_{GE}$	Gate-emitter voltage	$\pm 20$	V
$V_{ECR}$	Emitter-collector voltage	20	V
$E_{AS}^{(4)}$	Single pulse avalanche energy at $T_C = 25\text{ °C}$	10	mJ
	Single pulse avalanche energy at $T_C = 100\text{ °C}$	7	mJ
$P_{TOT}$	Total dissipation at $T_C = 25\text{ °C}$	75	W
$T_j$	Operating junction temperature	- 55 to 150	$^{\circ}\text{C}$

1. Calculated according to the iterative formula:

$$I_C(T_C) = \frac{T_{j(\max)} - T_C}{R_{thj-c} \times V_{CE(\text{sat})}(\max)(T_{j(\max)}, I_C(T_C))}$$

2. Pulse width limited by max. temperature allowed
3.  $V_{CLAMP} = 80\% (V_{CES})$ ,  $V_{GE} = 15\text{ V}$ ,  $R_G = 10\ \Omega$ ,  $T_J = 150\text{ °C}$
4.  $V_{CE} = 50\text{ V}$ ,  $I_{AV} = 3.3\text{ A}$

**Table 3. Thermal resistance**

Symbol	Parameter	Value	Unit
$R_{thj-case}$	Thermal resistance junction-case IGBT max	1.67	$^{\circ}\text{C/W}$
$R_{thj-amb}$	Thermal resistance junction-ambient max	100	$^{\circ}\text{C/W}$

## 2 Electrical characteristics

( $T_{CASE}=25\text{ °C}$  unless otherwise specified)

**Table 4. Static electrical characteristics**

Symbol	Parameter	Test conditions	Min.	Typ.	Max.	Unit
$V_{(BR)CES}$	Collector-emitter breakdown voltage ( $V_{GE} = 0$ )	$I_C = 10\text{ mA}$	1200			V
$V_{CE(sat)}$	Collector-emitter saturation voltage	$V_{GE} = 15\text{ V}$ , $I_C = 5\text{ A}$ $V_{GE} = 15\text{ V}$ , $I_C = 5\text{ A}$ , $T_C = 125\text{ °C}$		1.3 1.2	2.0	V V
$V_{GE(th)}$	Gate threshold voltage	$V_{CE} = V_{GE}$ , $I_C = 250\text{ }\mu\text{A}$	2		5	V
$V_{GE}$	Gate emitter voltage	$V_{CE} = 2.5\text{ V}$ , $I_C = 2\text{ A}$ , $T_C = 25 \div 125\text{ °C}$			6.5	V
$I_{CES}$	Collector cut-off current ( $V_{GE} = 0$ )	$V_{CE} = 900\text{ V}$ $V_{CE} = 900\text{ V}$ , $T_C = 125\text{ °C}$			50 250	$\mu\text{A}$ $\mu\text{A}$
$I_{GES}$	Gate-emitter leakage current ( $V_{CE} = 0$ )	$V_{GE} = \pm 20\text{ V}$			$\pm 100$	nA
$g_{fs}$	Forward transconductance	$V_{CE} = 15\text{ V}$ , $I_C = 5\text{ A}$		5		S
$R_G$	Gate resistance			4		k $\Omega$

**Table 5. Dynamic electrical characteristics**

Symbol	Parameter	Test conditions	Min.	Typ.	Max.	Unit
$C_{ies}$	Input capacitance	$V_{CE} = 25\text{ V}$ , $f = 1\text{ MHz}$ , $V_{GE} = 0$		430		pF
$C_{oes}$	Output capacitance			40		pF
$C_{res}$	Reverse transfer capacitance			7		pF

**Table 6. Switching on/off (inductive load)**

Symbol	Parameter	Test conditions	Min.	Typ.	Max.	Unit
$t_{d(on)}$	Turn-on delay time	$V_{CC} = 960 \text{ V}, I_C = 5 \text{ A}$		690		ns
$t_r$	Current rise time	$R_{drive} = 1 \text{ k}\Omega, V_{GE} = 15 \text{ V},$ <i>(see Figure 18)</i>		170		ns
$(di/dt)_{on}$	Turn-on current slope			39.6		A/ $\mu$ s
$t_{d(on)}$	Turn-on delay time	$V_{CC} = 960 \text{ V}, I_C = 5 \text{ A}$		600		ns
$t_r$	Current rise time	$R_{drive} = 1 \text{ k}\Omega, V_{GE} = 15 \text{ V}$		185		ns
$(di/dt)_{on}$	Turn-on current slope	$T_C = 125 \text{ }^\circ\text{C}$ <i>(see Figure 18)</i>		39		A/ $\mu$ s
$t_c$	Cross-over time	$V_{CC} = 960 \text{ V}, I_C = 5 \text{ A}$		4		$\mu$ s
$t_r(V_{off})$	Off voltage rise time	$R_{drive} = 1 \text{ k}\Omega, V_{GE} = 15 \text{ V}$		2.2		$\mu$ s
$t_{d(off)}$	Turn-off delay time	<i>(see Figure 18)</i>		12.1		$\mu$ s
$t_f$	Current fall time			1.13		$\mu$ s
$t_c$	Cross-over time	$V_{CC} = 960 \text{ V}, I_C = 5 \text{ A}$		5		$\mu$ s
$t_r(V_{off})$	Off voltage rise time	$R_{drive} = 1 \text{ k}\Omega, V_{GE} = 15 \text{ V},$		2.2		$\mu$ s
$t_{d(off)}$	Turn-off delay time	$T_C = 125 \text{ }^\circ\text{C}$ <i>(see Figure 18)</i>		12.1		$\mu$ s
$t_f$	Current fall time			2		$\mu$ s

**Table 7. Switching energy (inductive load)**

Symbol	Parameter	Test conditions	Min.	Typ.	Max.	Unit
$E_{on}^{(1)}$	Turn-on switching losses	$V_{CC} = 960 \text{ V}, I_C = 5 \text{ A}$		2.59		mJ
$E_{off}^{(2)}$	Turn-off switching losses	$R_{drive} = 1 \text{ k}\Omega, V_{GE} = 15 \text{ V}$		9		mJ
$E_{ts}$	Total switching losses	<i>(see Figure 18)</i>		11.59		mJ
$E_{on}^{(1)}$	Turn-on switching losses	$V_{CC} = 960 \text{ V}, I_C = 5 \text{ A}$		2.64		mJ
$E_{off}^{(2)}$	Turn-off switching losses	$R_{drive} = 1 \text{ k}\Omega, V_{GE} = 15 \text{ V},$		10.2		mJ
$E_{ts}$	Total switching losses	$T_C = 125 \text{ }^\circ\text{C}$ <i>(see Figure 18)</i>		12.68		mJ

- $E_{on}$  is the turn-on losses when a typical diode is used in the test circuit in *(see Figure 18)*. If the IGBT is offered in a package with a co-pak diode, the co-pak diode is used as external diode. IGBTs & Diode are at the same temperature (25°C and 125°C)
- Turn-off losses include also the tail of the collector current

**Table 8. Functional test**

Symbol	Parameter	Test conditions	Min.	Typ.	Max.	Unit
$I_{AS}$	Unclamped inductive switching current	$V_{CC} = 50 \text{ V}, L = 1.8 \text{ mH}$ $T_{start} = 25 \text{ }^\circ\text{C}, R_{drive} = 1 \text{ k}\Omega$	3.3			A

## 2.1 Electrical characteristics (curves)

Figure 2. Output characteristics

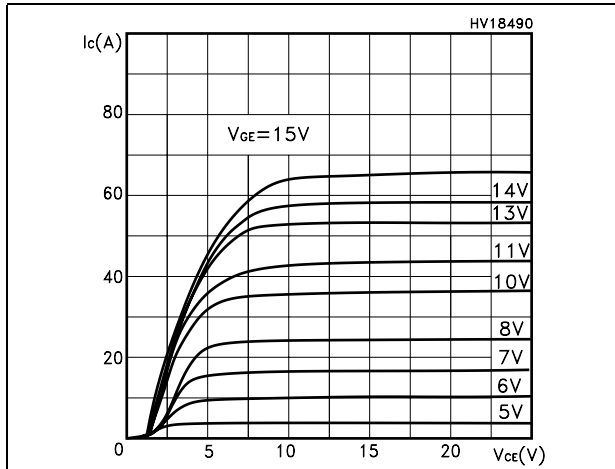

Figure 3. Transfer characteristics

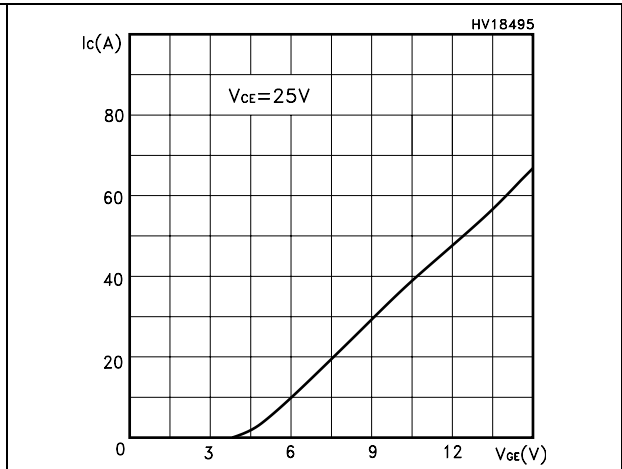

Figure 4. Transconductance

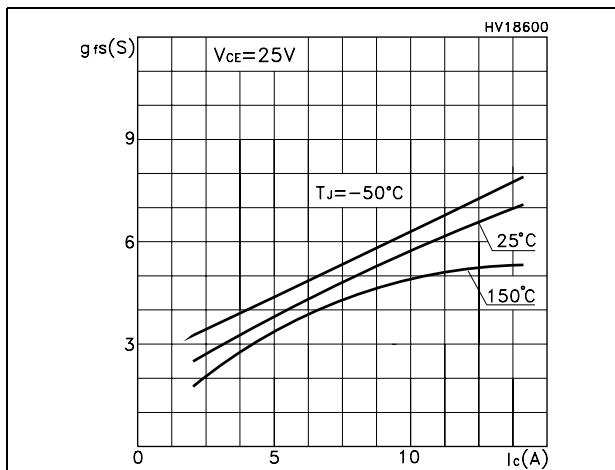

Figure 5. Collector-emitter on voltage vs temperature

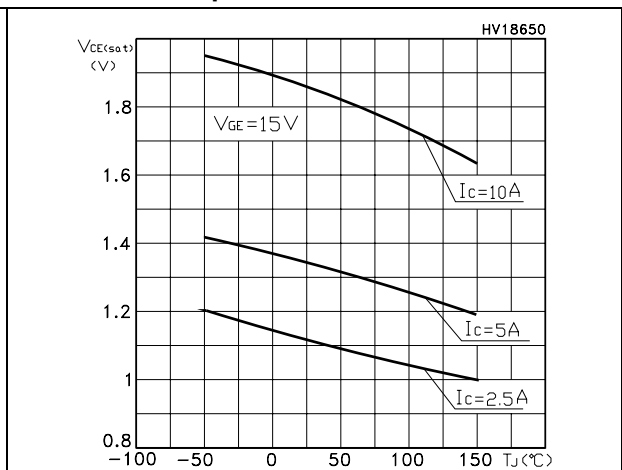

Figure 6. Gate charge vs gate-source voltage

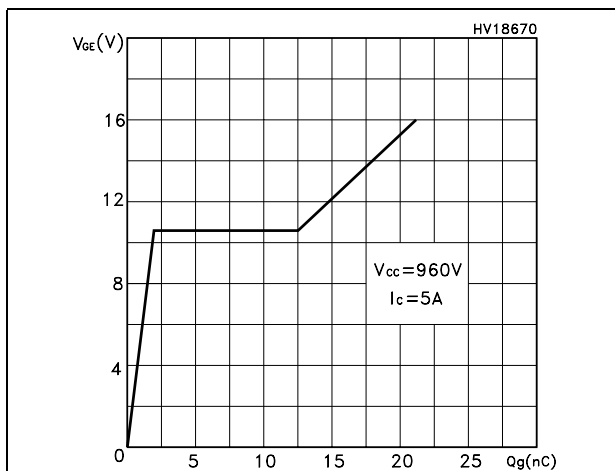

Figure 7. Capacitance variations

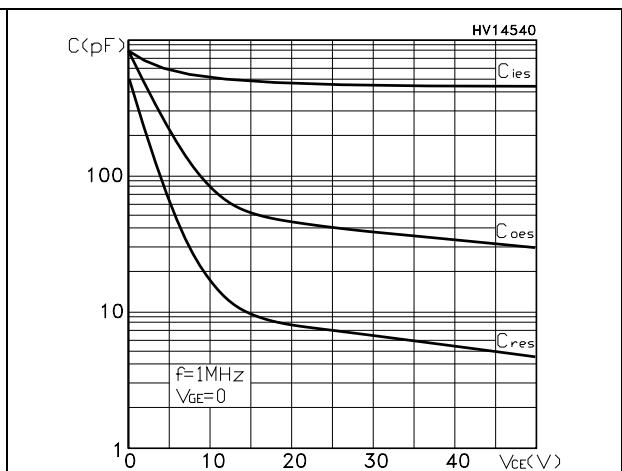

Figure 8. Normalized gate threshold voltage vs temperature

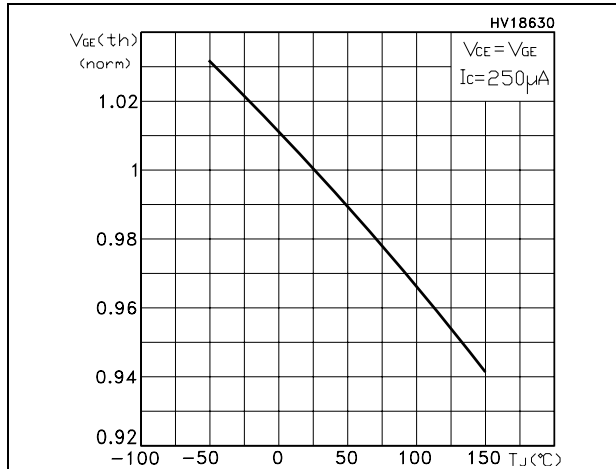

Figure 9. Collector-emitter on voltage vs collector current

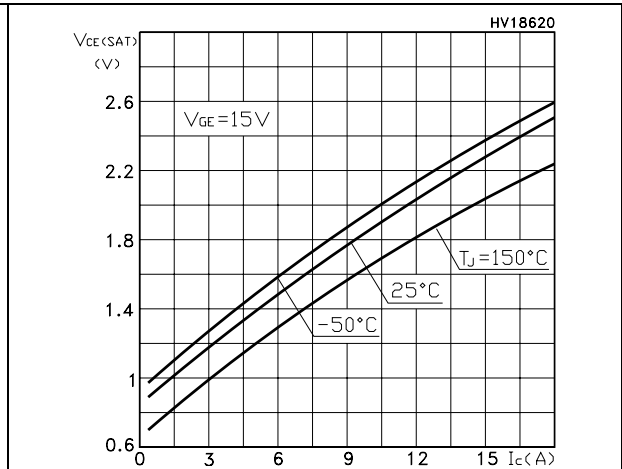

Figure 10. Breakdown voltage vs temperature

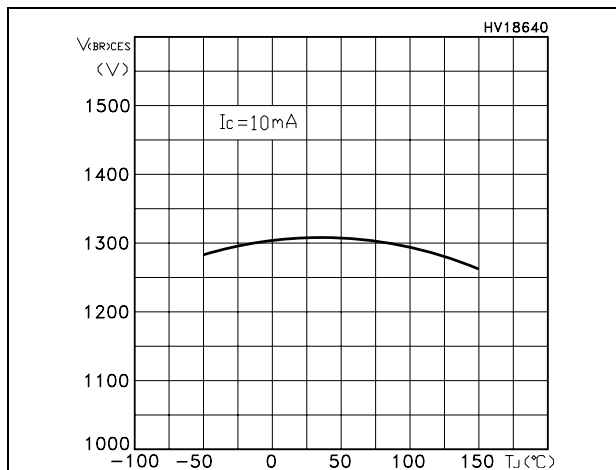

Figure 11. Normalized collector-emitter on voltage vs temperature

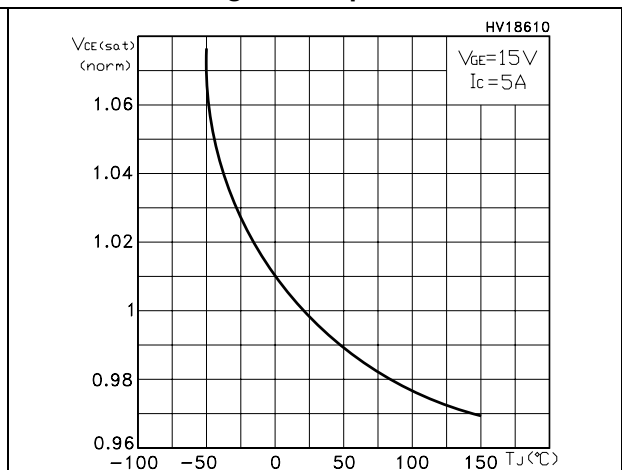

Figure 12. Switching losses vs gate resistance

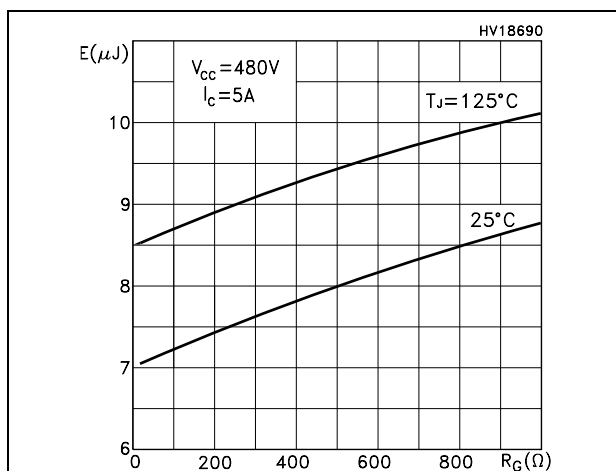

Figure 13. Switching losses vs collector current

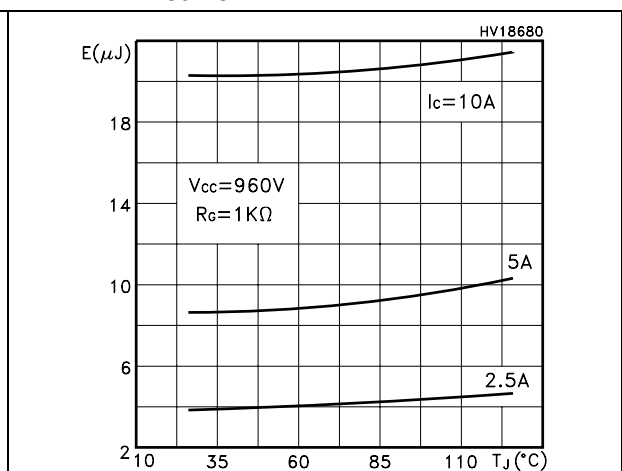

Figure 14. Turn-off SOA

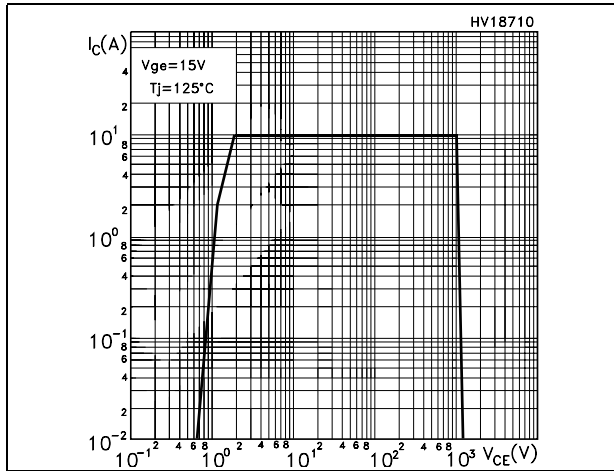
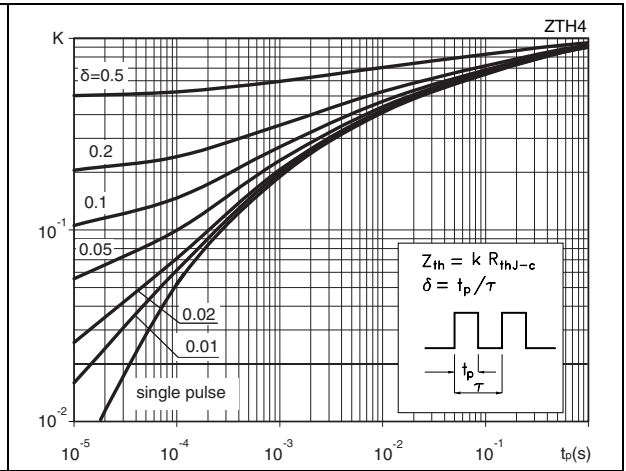

Figure 15. Thermal impedance





### 3 Test circuit

Figure 16. Test circuit for inductive load switching

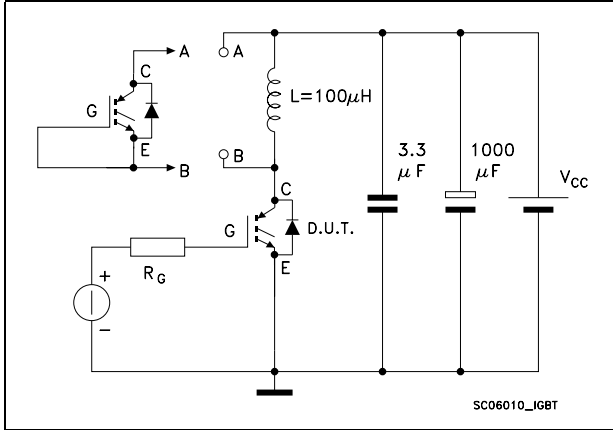

Figure 17. Gate charge test circuit

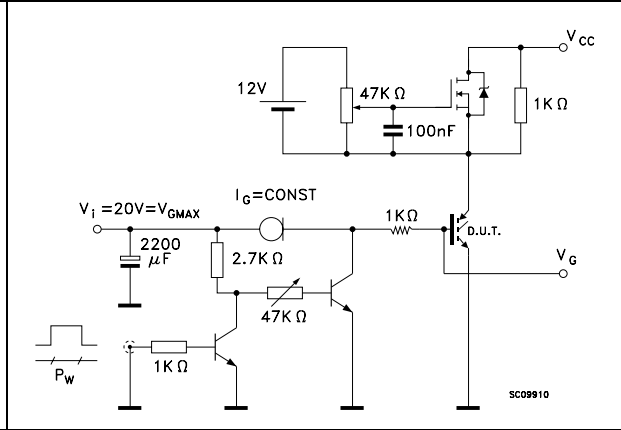
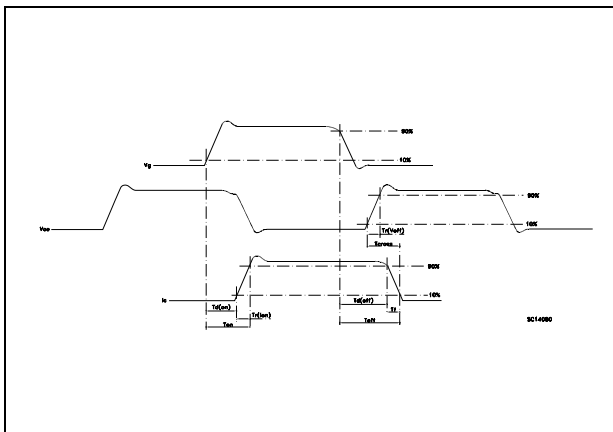

Figure 18. Switching waveform



## 4 Package mechanical data

In order to meet environmental requirements, ST offers these devices in ECOPACK® packages. These packages have a Lead-free second level interconnect. The category of second level interconnect is marked on the package and on the inner box label, in compliance with JEDEC Standard JESD97. The maximum ratings related to soldering conditions are also marked on the inner box label. ECOPACK is an ST trademark. ECOPACK specifications are available at: [www.st.com](http://www.st.com)

**TO-252 (DPAK) mechanical data**

DIM.	mm.		
	min.	typ	max.
A	2.20		2.40
A1	0.90		1.10
A2	0.03		0.23
b	0.64		0.90
b4	5.20		5.40
c	0.45		0.60
c2	0.48		0.60
D	6.00		6.20
D1		5.10	
E	6.40		6.60
E1		4.70	
e		2.28	
e1	4.40		4.60
H	9.35		10.10
L	1		
L1		2.80	
L2		0.80	
L4	0.60		1
R		0.20	
V2	0°		8°

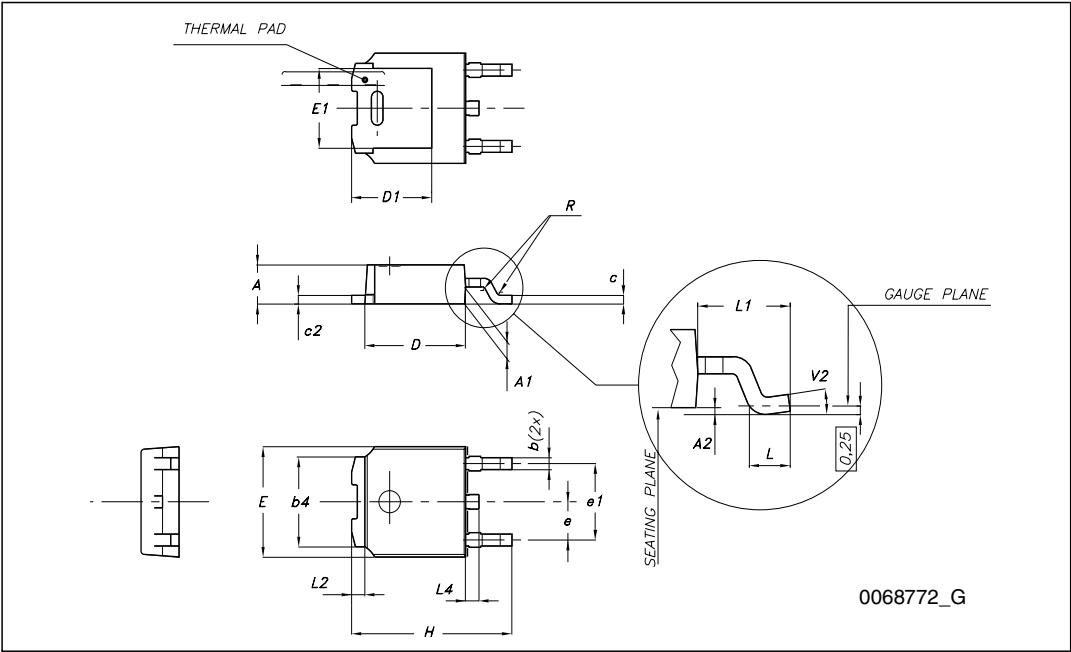

**TO-251 (IPAK) mechanical data**

DIM.	mm.		
	min.	typ	max.
A	2.20		2.40
A1	0.90		1.10
b	0.64		0.90
b2			0.95
b4	5.20		5.40
c	0.45		0.60
c2	0.48		0.60
D	6.00		6.20
E	6.40		6.60
e		2.28	
e1	4.40		4.60
H		16.10	
L	9.00		9.40
(L1)	0.80		1.20
L2		0.80	
V1		10°	

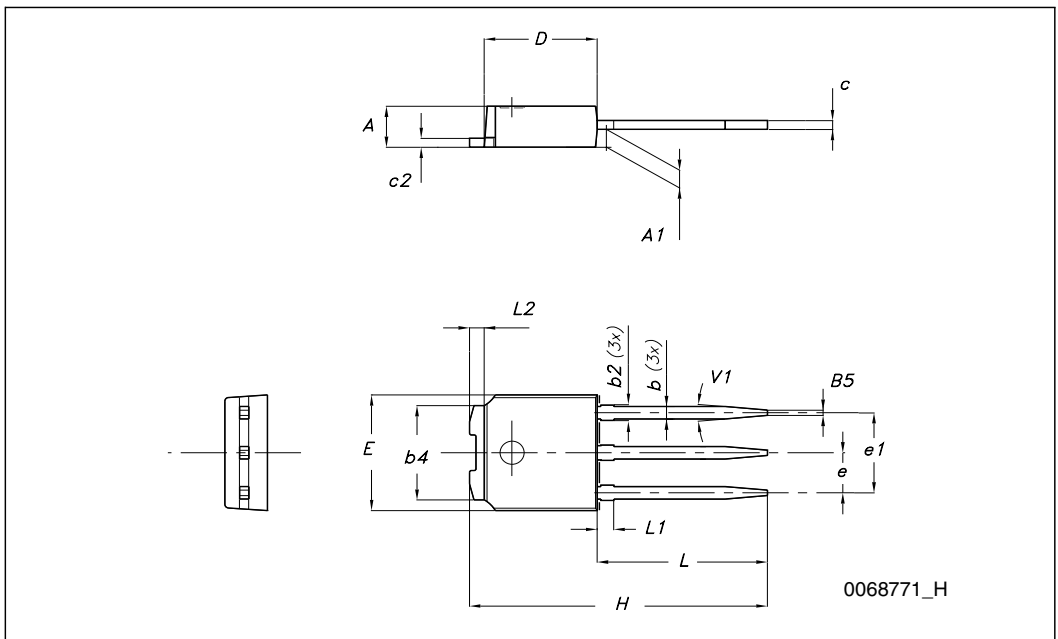

## 5 Packaging mechanical data

### DPAK FOOTPRINT

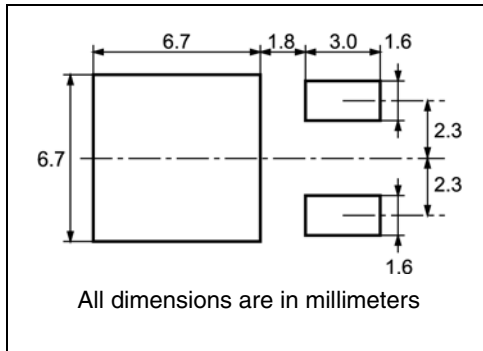

### TAPE AND REEL SHIPMENT

DIM.	mm		inch	
	MIN.	MAX.	MIN.	MAX.
A		330		12.992
B	1.5		0.059	
C	12.8	13.2	0.504	0.520
D	20.2		0.795	
G	16.4	18.4	0.645	0.724
N	50		1.968	
T		22.4		0.881

BASE QTY		BULK QTY	
2500		2500	

DIM.	mm		inch	
	MIN.	MAX.	MIN.	MAX.
A0	6.8	7	0.267	0.275
B0	10.4	10.6	0.409	0.417
B1		12.1		0.476
D	1.5	1.6	0.059	0.063
D1	1.5		0.059	
E	1.65	1.85	0.065	0.073
F	7.4	7.6	0.291	0.299
K0	2.55	2.75	0.100	0.108
P0	3.9	4.1	0.153	0.161
P1	7.9	8.1	0.311	0.319
P2	1.9	2.1	0.075	0.082
R	40		1.574	
W	15.7	16.3	0.618	0.641

## 6 Revision history

**Table 9. Document revision history**

Date	Revision	Changes
06-Oct-2003	5	No history because migration
18-Jan-2005	6	Final datasheet
13-Nov-2008	7	Insert new value in <a href="#">Table 2: Absolute maximum ratings</a>

**Please Read Carefully:**

Information in this document is provided solely in connection with ST products. STMicroelectronics NV and its subsidiaries ("ST") reserve the right to make changes, corrections, modifications or improvements, to this document, and the products and services described herein at any time, without notice.

All ST products are sold pursuant to ST's terms and conditions of sale.

Purchasers are solely responsible for the choice, selection and use of the ST products and services described herein, and ST assumes no liability whatsoever relating to the choice, selection or use of the ST products and services described herein.

No license, express or implied, by estoppel or otherwise, to any intellectual property rights is granted under this document. If any part of this document refers to any third party products or services it shall not be deemed a license grant by ST for the use of such third party products or services, or any intellectual property contained therein or considered as a warranty covering the use in any manner whatsoever of such third party products or services or any intellectual property contained therein.

**UNLESS OTHERWISE SET FORTH IN ST'S TERMS AND CONDITIONS OF SALE ST DISCLAIMS ANY EXPRESS OR IMPLIED WARRANTY WITH RESPECT TO THE USE AND/OR SALE OF ST PRODUCTS INCLUDING WITHOUT LIMITATION IMPLIED WARRANTIES OF MERCHANTABILITY, FITNESS FOR A PARTICULAR PURPOSE (AND THEIR EQUIVALENTS UNDER THE LAWS OF ANY JURISDICTION), OR INFRINGEMENT OF ANY PATENT, COPYRIGHT OR OTHER INTELLECTUAL PROPERTY RIGHT.**

**UNLESS EXPRESSLY APPROVED IN WRITING BY AN AUTHORIZED ST REPRESENTATIVE, ST PRODUCTS ARE NOT RECOMMENDED, AUTHORIZED OR WARRANTED FOR USE IN MILITARY, AIR CRAFT, SPACE, LIFE SAVING, OR LIFE SUSTAINING APPLICATIONS, NOR IN PRODUCTS OR SYSTEMS WHERE FAILURE OR MALFUNCTION MAY RESULT IN PERSONAL INJURY, DEATH, OR SEVERE PROPERTY OR ENVIRONMENTAL DAMAGE. ST PRODUCTS WHICH ARE NOT SPECIFIED AS "AUTOMOTIVE GRADE" MAY ONLY BE USED IN AUTOMOTIVE APPLICATIONS AT USER'S OWN RISK.**

Resale of ST products with provisions different from the statements and/or technical features set forth in this document shall immediately void any warranty granted by ST for the ST product or service described herein and shall not create or extend in any manner whatsoever, any liability of ST.

ST and the ST logo are trademarks or registered trademarks of ST in various countries.

Information in this document supersedes and replaces all information previously supplied.

The ST logo is a registered trademark of STMicroelectronics. All other names are the property of their respective owners.

© 2008 STMicroelectronics - All rights reserved

STMicroelectronics group of companies

Australia - Belgium - Brazil - Canada - China - Czech Republic - Finland - France - Germany - Hong Kong - India - Israel - Italy - Japan - Malaysia - Malta - Morocco - Singapore - Spain - Sweden - Switzerland - United Kingdom - United States of America

[www.st.com](http://www.st.com)