

Micropower 1A synchronous step-up DC-DC converter

Features

- Very low supply current: 500µA (typ)
- Output voltage adjustable from 6V to 12V
- Output voltage accuracy: ±2%
- Output current up to 1A
- Low ripple voltage: 5mV (typ)
- Synchronous rectification
- High 90% efficiency: $V_O = 9V$ (typ)
- Few external components
- Very small DFN8 (4x4mm) package

Description

The ST8R00 family of low quiescent current, synchronous PWM step-up DC-DC converters offer high efficiency even in light load conditions. The ST8R00 accepts a positive input voltage from 4 to 6V and provides an output voltage in the 6 to 12V range.

The ST8R00 is developed in two versions: Burst mode and Continuous mode. The Burst mode version functions in discontinuous mode, allowing the device to maintain the regulated voltage in no load conditions by turning off the internal switches. The Continuous mode version,

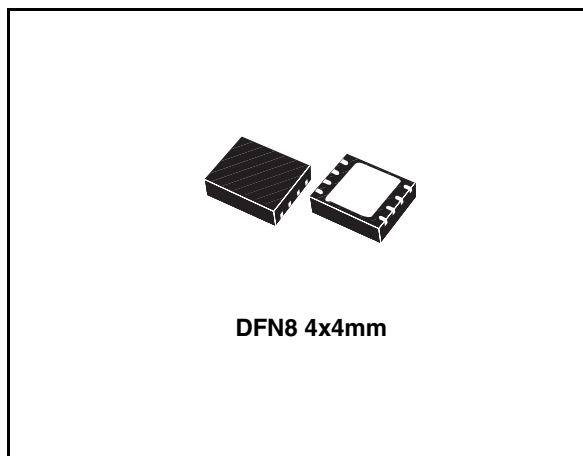

ST8R00W, guarantees the lowest switching ripple when the device is used at light load conditions.

The high switching frequency and internally limited peak inductor current permit the use of small, low-cost inductors. Only three external components are required: an inductor and two ceramic capacitors.

The ST8R00 is suitable for use in equipment where low noise, low ripple and low supply current are required. The ST8R00 is available in a very small DFN8 4x4mm package.

Order codes

Part number	Package	Output voltages
ST8R00 ⁽¹⁾	ST8R00PUR	ADJ
ST8R00W ⁽²⁾	ST8R00WPUR	ADJ

1. Burst mode at light load

2. Full PWM mode

Contents

1	Block diagram	3
2	Pin configuration	4
3	Typical application circuit	5
4	Maximum ratings	6
5	Electrical characteristics	7
6	Typical characteristics	9
7	Package mechanical data	14
8	Revision history	18

1 Block diagram

Figure 1. Schematic diagram

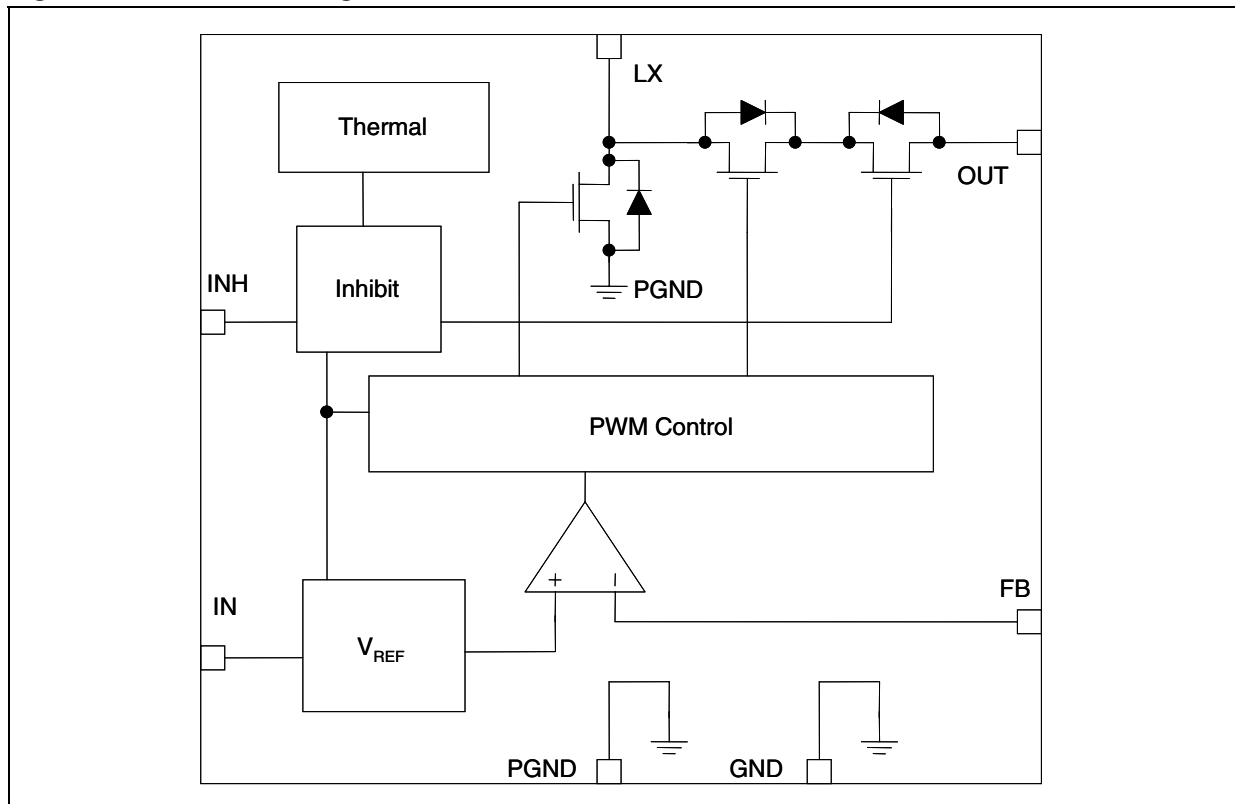

2 Pin configuration

Figure 2. Pin connections (top view)

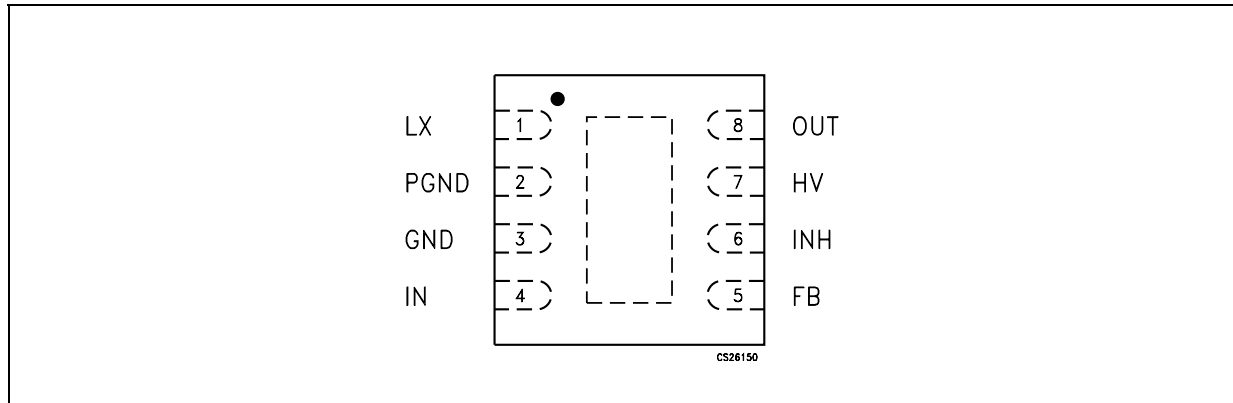
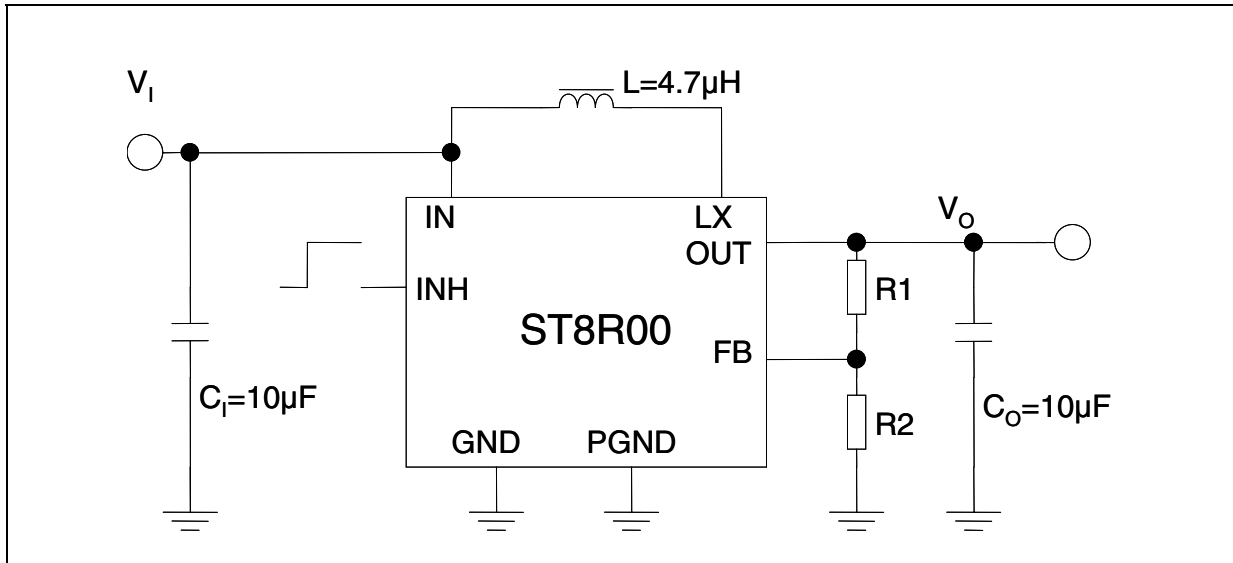

Table 1. Pin description

Pin n°	Symbol	Name and function
1	LX	Switching output
2	PGND	Power ground
3	GND	Analog ground
4	IN	Power input for analog circuit
5	FB	Feedback
6	INH	Inhibit. Connecting the pin to a voltage higher than 2V = device ON. Connecting the pin to a voltage lower than 0.8V = device OFF, resulting in no current flow to the load
7	HV	Trimming (floating or connected to GND)
8	OUT	Output voltage
EXP pad	GND	Exposed pad. Must be connected to GND

3 Typical application circuit

Figure 3. Application circuit



4 Maximum ratings

Table 2. Absolute maximum ratings

Symbol	Parameter	Value	Unit
V_O	Output voltage	16	V
V_I	Input voltage	6	V
V_{INH}	Inhibit voltage	6	V
V_{LX}	LX pin voltage	16	V
I_{LX}	LX pin output current	Internally limited	
T_{STG}	Storage temperature range	-50 to 150	°C
T_{OP}	Operating junction temperature range	-25 to 125	°C

Table 3. Thermal Data

Symbol	Parameter	Value	Unit
R_{thJC}	Thermal resistance junction-case	10	°C/W
R_{thJA}	Thermal resistance junction-ambient	50	°C/W

Table 4. ESD Performance

Symbol	Parameter	Test conditions	Value	Unit
ESD	ESD protection voltage	HBM	4	KV
ESD	ESD protection voltage	MM	500	V

5 Electrical characteristics

Table 5. Electrical characteristics for the ST8R00 ($V_I = 5V$, $V_{INH} = 2V$, $I_O = 100mA$, $T_J = -25^\circ C$ to $125^\circ C$, $C_I = C_O = 10\mu F(X7R)$, $L = 4.7\mu H$ unless otherwise specified.)

Symbol	Parameter	Test conditions	Min.	Typ.	Max.	Unit
V_O	Output voltage	(1)	6		12	V
$V_{START-UP}$	Start-up voltage	$I_O = 400mA$, V_I rising		3	3.5	V
V_I	Input voltage range		4		6	V
V_{FB}	Feedback voltage	$I_O = 50mA$	1.195	1.22	1.245	V
V_{FB_OFF}	Feedback voltage	$I_O = 0$, $V_{INH} = 0$		0		V
I_{FB}	Feedback current	$V_{FB} = 0$, $V_{INH} = 2V$		600		nA
I_{SUPPLY}	Supply current	To be measured at V_I , no load		500		μA
R_{DSON_N}	Internal N channel R_{DSON}	$I_{LX} = 400mA$		300		m Ω
R_{DSON_P}	Internal P channel R_{DSON}	$I_{LX} = 400mA$		300		
$I_{LX(leak)}$	Internal leakage current	$V_{LX} = 4V$, $V_{FB} = 2V$, $V_{INH} = 0$			0.5	μA
$I_{LX(LIM)}$	LX current limitation	$V_{LX} = 4V$		3		A
f_{OSC}	Oscillator frequency	To be measured on LX pin	0.8	1.2	1.4	MHz
D_{TY}	Max. oscillator duty cycle	To be measured on LX pin		90		%
Eff	Efficiency	$I_O = 100mA$, $V_O = 9V$		80		%
		$I_O = 500mA$, $V_O = 9V$		90		
		$I_O = 1A$, $V_O = 9V$		90		
V_{INH_H}	Inhibit threshold high		2			V
V_{INH_L}	Inhibit threshold low	$V_I = 4$ to $6V$, $I_O = 50mA$			0.8	
I_{INH}	Inhibit pin current	$V_{INH} = V_I = 5V$			2	μA
T_{SHDN}	Thermal shut down (2)		130	150		$^\circ C$
T_{HYS}	Thermal shut down hysteresis (2)			15		$^\circ C$
$\Delta V_O/\Delta V_I$	Line transient response	V_I from 4 to 5.5V, $I_O = 500mA$ (2)	-5		5	% V_O
$\Delta V_O/\Delta I_O$	Load transient response	$V_I = 5V$, I_O from 10mA to 500mA, $V_O = 7V$ (2)	-5		5	% V_O
$\Delta V_O/\Delta V_I$	Start-up transient	V_I from 0 to 5V, $I_O = 500mA$	-10		10	% V_O
T_{START}	Start-up time	V_{INH} from 0 to 5V, $I_O = 100mA$		500		μs

1. For V_O higher than 9V the maximum output current capability is reduced according to LX current limitation

2. Guaranteed by design

Table 6. Electrical characteristics for the ST8R00W ($V_I = 5V$, $V_{INH} = 2V$, $I_O = 100mA$, $T_J = -25^\circ C$ to $125^\circ C$, $C_I = C_O = 10\mu F(X7R)$, $L = 4.7\mu H$ unless otherwise specified.)

Symbol	Parameter	Test conditions	Min.	Typ.	Max.	Unit
V_O	Output voltage	(1)	6		12	V
$V_{START-UP}$	Start-up voltage	$I_O = 400mA$, V_I rising		3	3.5	V
V_I	Input voltage range		4		6	V
V_{FB}	Feedback voltage	$I_O = 50mA$	1.195	1.22	1.245	V
V_{FB_OFF}	Feedback voltage	$I_O = 0$, $V_{INH} = 0$		0		V
I_{FB}	Feedback current	$V_{FB} = 0$, $V_{INH} = 2V$		600		nA
I_{SUPPLY}	Supply current	To be measured at V_I , $V_O = 7V$, no load		10		mA
R_{DSON_N}	Internal N channel R_{DSON}	$I_{LX} = 400mA$		300		m Ω
R_{DSON_P}	Internal P channel R_{DSON}	$I_{LX} = 400mA$		300		
$I_{LX(leak)}$	Internal leakage current	$V_{LX} = 4V$, $V_{FB} = 2V$, $V_{INH} = 0$			0.5	μA
$I_{LX(LIM)}$	LX current limitation	$V_{LX} = 4V$		3		A
f_{OSC}	Oscillator frequency	To be measured on LX pin	0.8	1.2	1.4	MHz
D_{TY}	Max. oscillator duty cycle	To be measured on LX pin		90		%
Eff	Efficiency	$I_O = 50mA$, $V_O = 7V$		85		%
		$I_O = 500mA$, $V_O = 9V$		90		
		$I_O = 1A$, $V_O = 9V$		90		
V_{INH_H}	Inhibit threshold high		2			V
V_{INH_L}	Inhibit threshold low	$V_I = 4$ to $6V$, $I_O = 50mA$			0.8	
I_{INH}	Inhibit pin current	$V_{INH} = V_I = 5V$			2	μA
T_{SHDN}	Thermal shut down (2)		130	150		$^\circ C$
T_{HYS}	Thermal shut down hysteresis (2)			15		$^\circ C$
$\Delta V_O/\Delta V_I$	Line transient response	V_I from 4 to 5.5V, $I_O = 500mA$ (2)	-5		5	% V_O
$\Delta V_O/\Delta I_O$	Load transient response	$V_I = 5V$, I_O from 10mA to 500mA, $V_O = 7V$ (2)	-5		5	% V_O
$\Delta V_O/\Delta V_I$	Start-up transient	V_I from 0 to 5V, $I_O = 500mA$	-10		10	% V_O
T_{START}	Start-up time	V_{INH} from 0 to 5V, $I_O = 100mA$		500		μs

1. For V_O higher than 9V the maximum output current capability is reduced according to LX current limitation
2. Guaranteed by design

6 Typical characteristics

($L = 4.7\mu\text{H}$, $C_1 = C_O = 10\mu\text{F}$)

Figure 4. Voltage feedback vs temperature

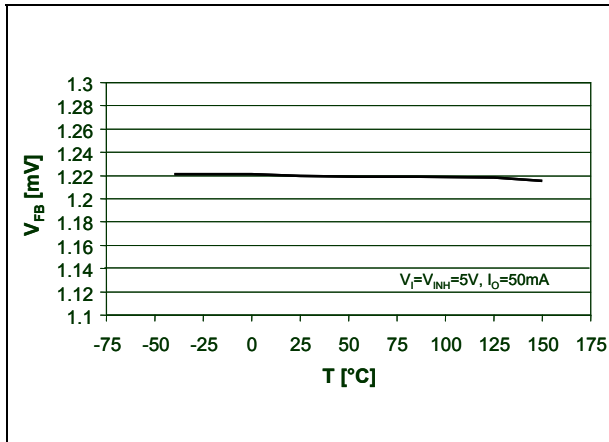

Figure 5. Feedback current vs temperature

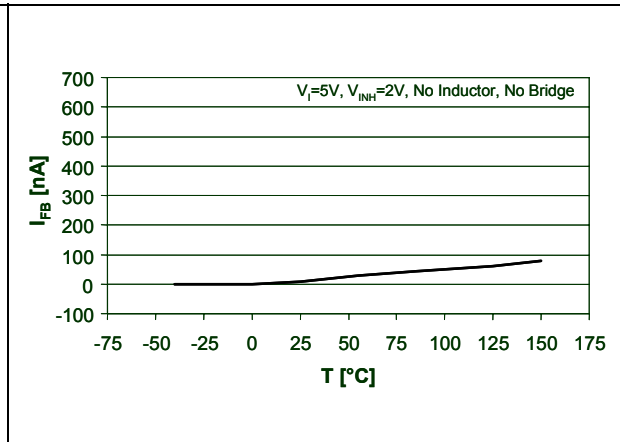

Figure 6. Supply current vs temperature (for ST8R00W)

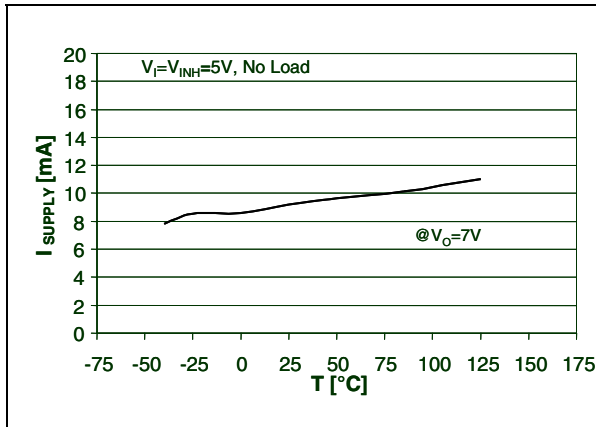

Figure 7. Supply current vs temperature (for ST8R00W)

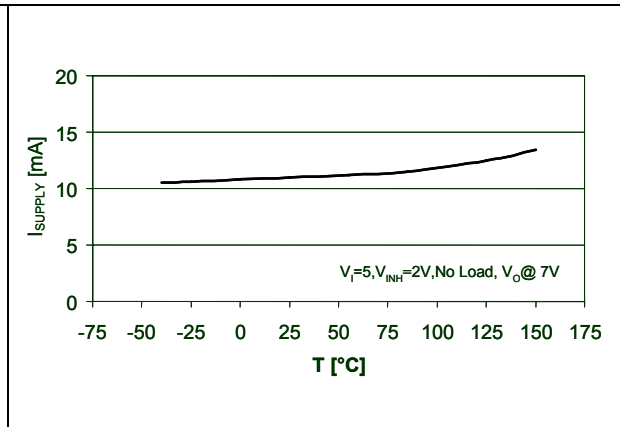

Figure 8. Supply current vs temperature (for ST8R00W)

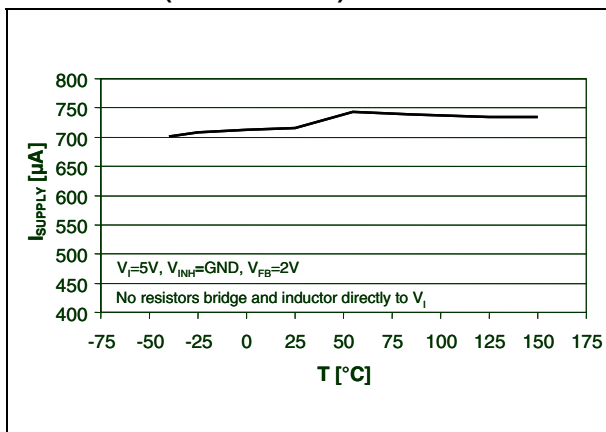

Figure 9. LX current limitation vs temperature

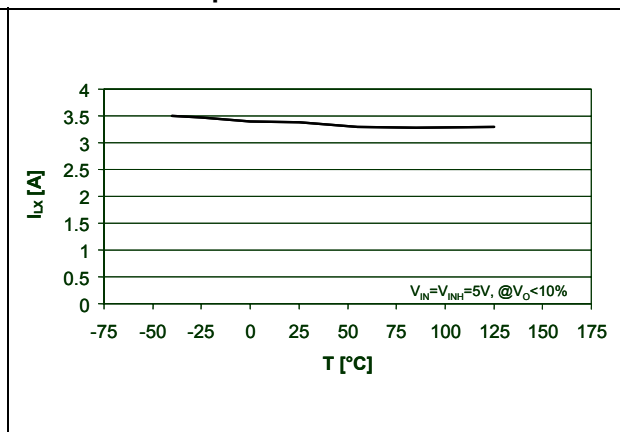

Figure 10. Inhibit voltage vs temperature

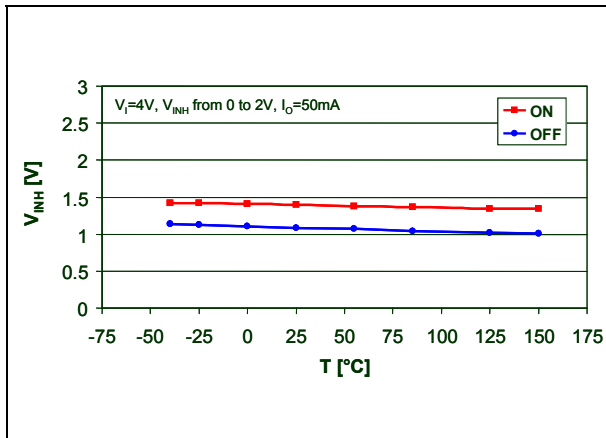

Figure 11. Inhibit voltage vs temperature

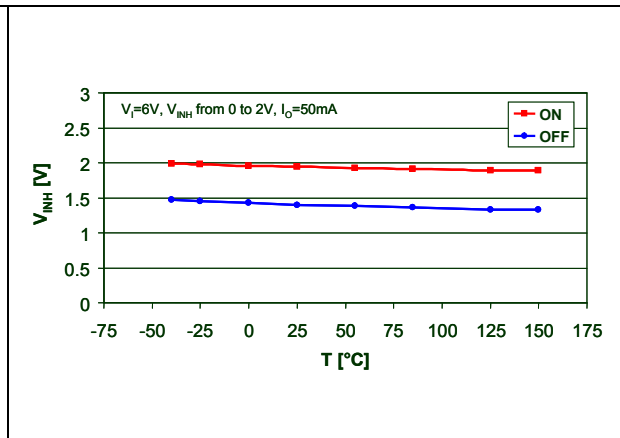

Figure 12. Line regulation vs temperature

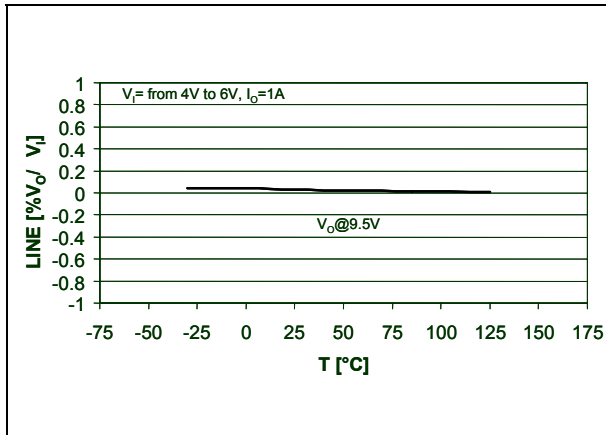

Figure 13. Load regulation vs temperature

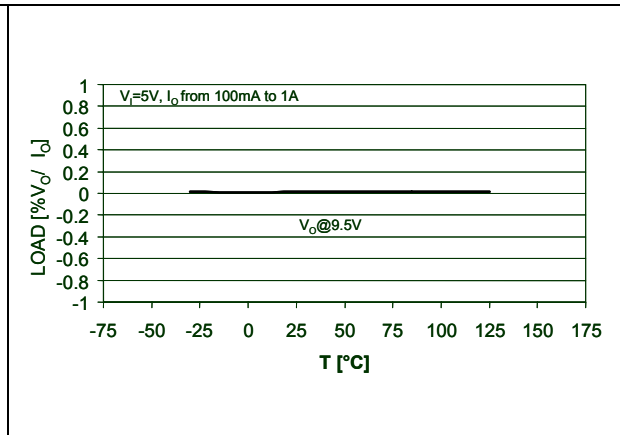

Figure 14. Oscillator frequency vs temperature

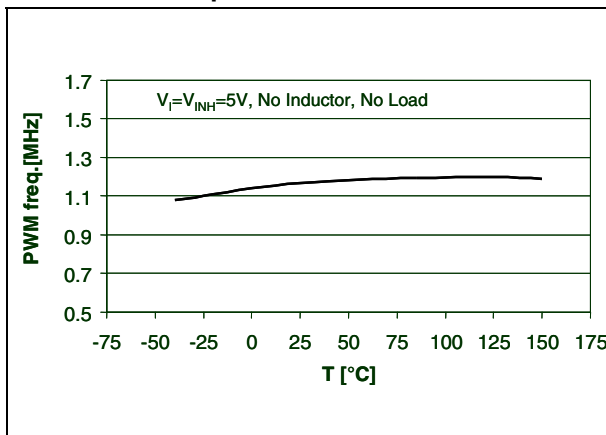

Figure 15. Max oscillator duty cycle vs temperature

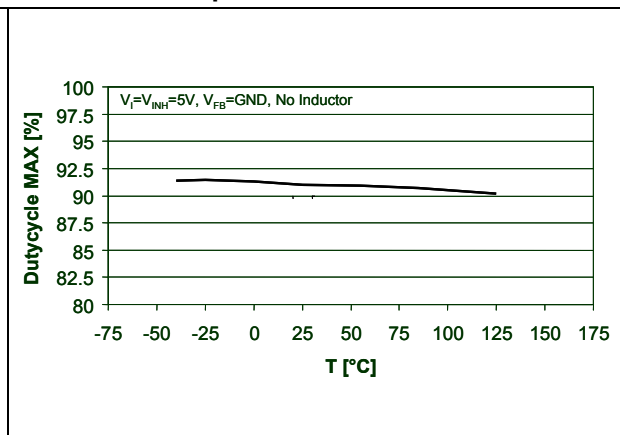

Figure 16. Internal leakage current vs temperature

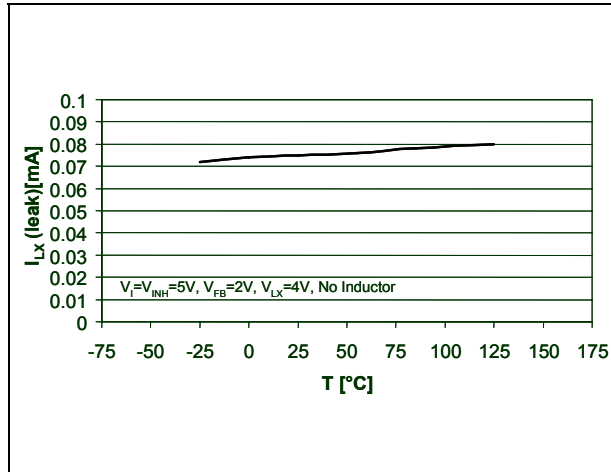

Figure 17. Internal leakage current vs temperature

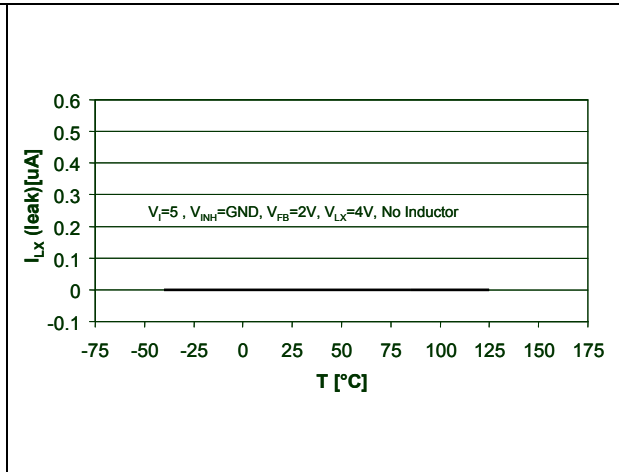

Figure 18. NMOS switch on resistance vs temperature

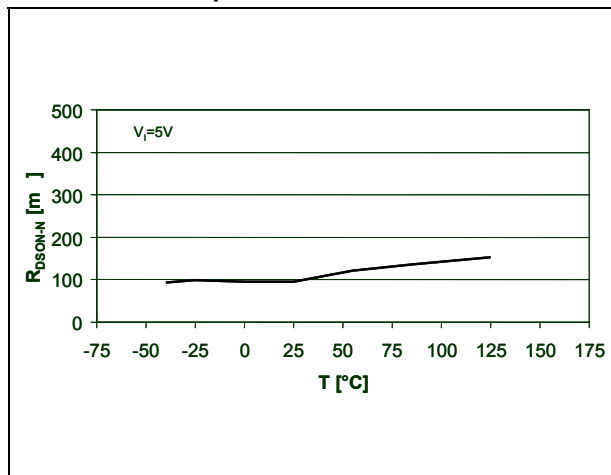

Figure 19. PMOS switch on resistance vs temperature

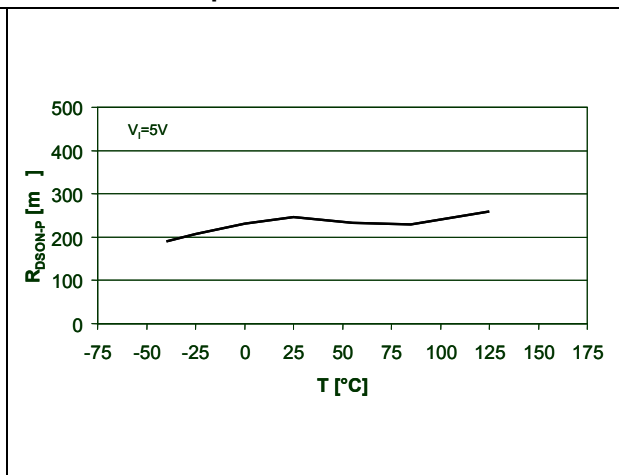

Figure 20. Efficiency vs output current (for ST8R00W)

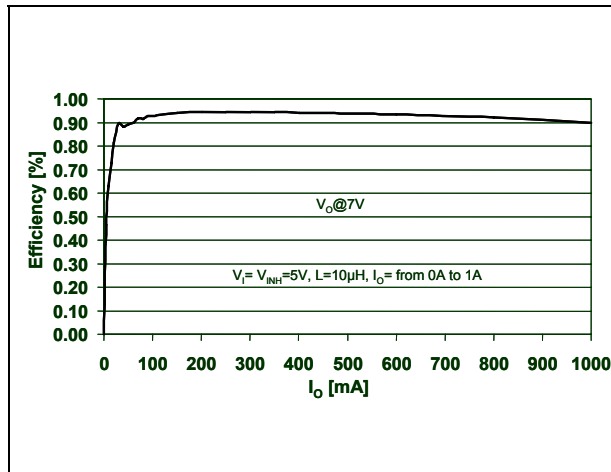

Figure 21. Efficiency vs output current (for ST8R00W)

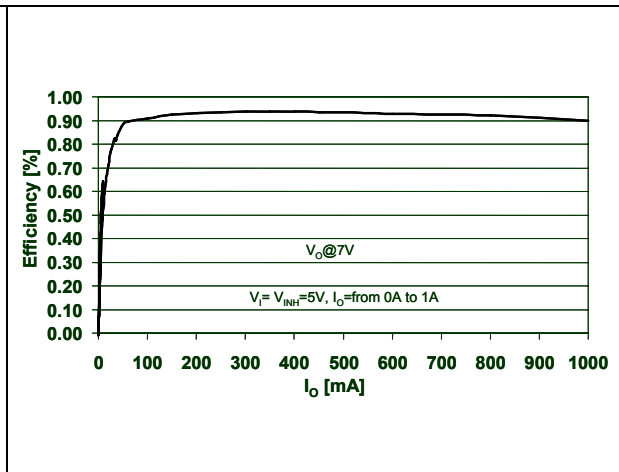

Figure 22. Output voltage vs input voltage (for ST8R00W)

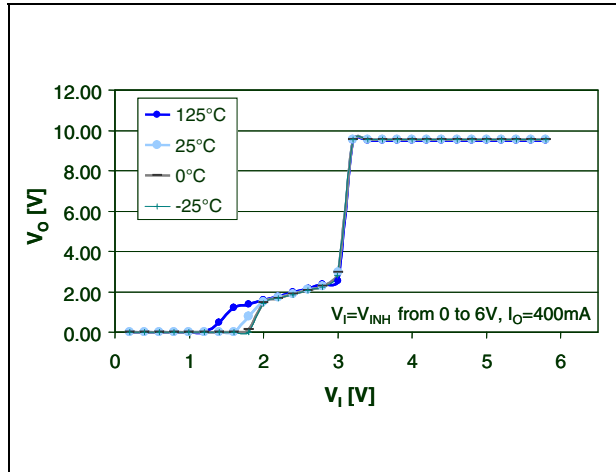

Figure 23. Maximum output current vs output voltage

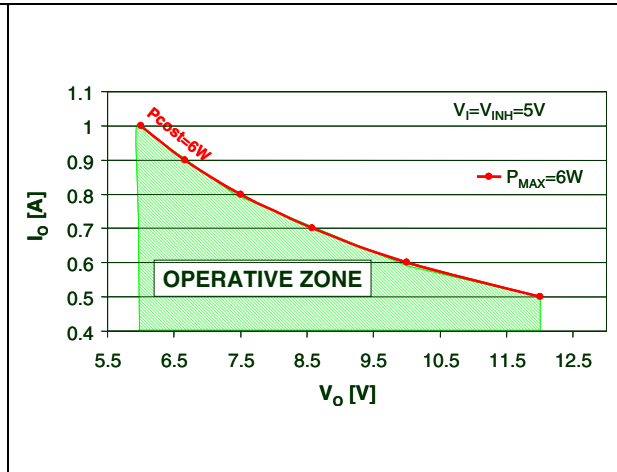

Figure 24. Efficiency vs output current

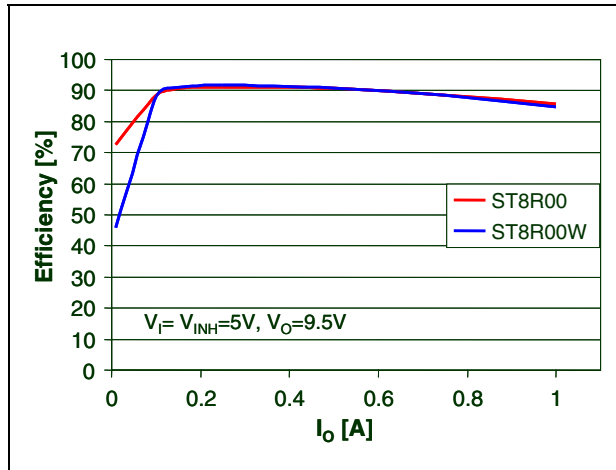

Figure 25. Efficiency vs input voltage

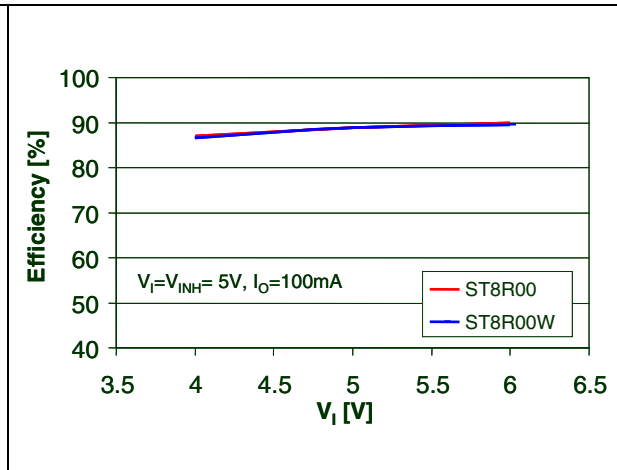

Figure 26. Efficiency vs input voltage

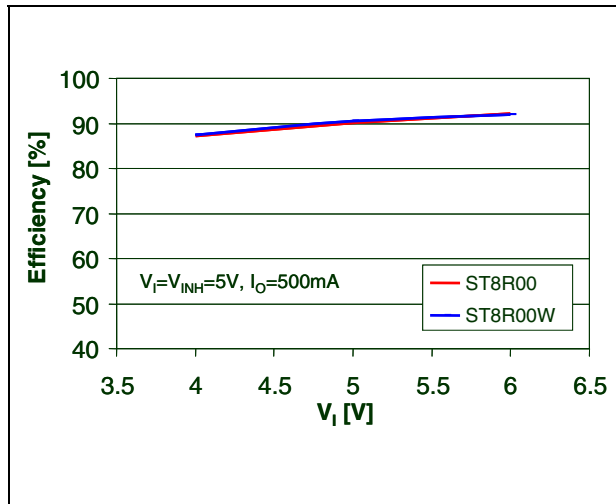

Figure 27. Inductor current (for ST8R00W)

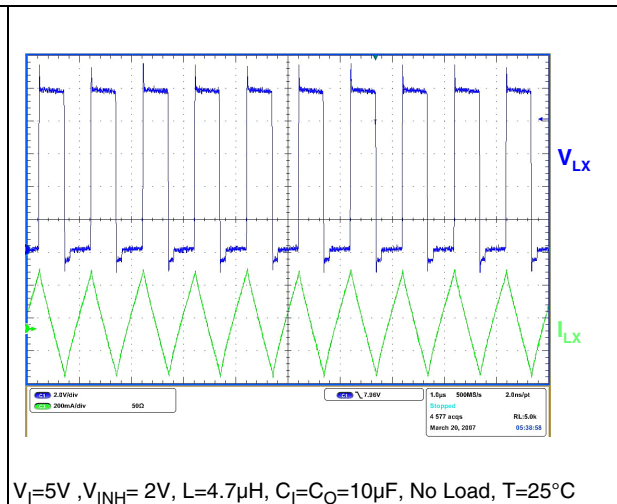

Figure 28. Load transient

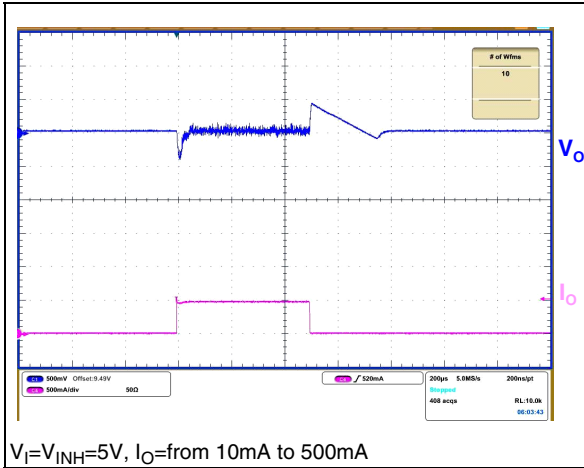

Figure 29. Line transient

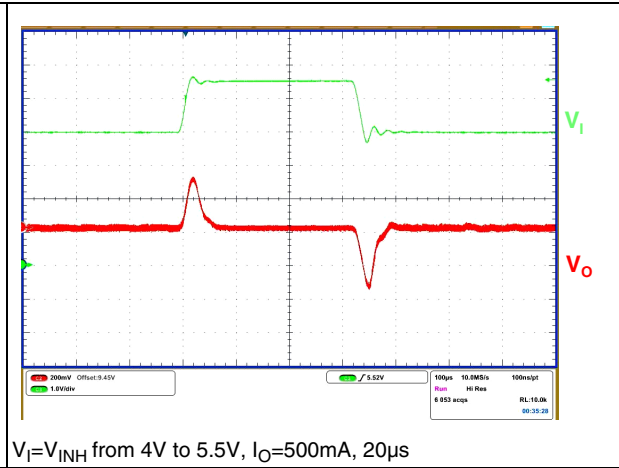

Figure 30. INH transient

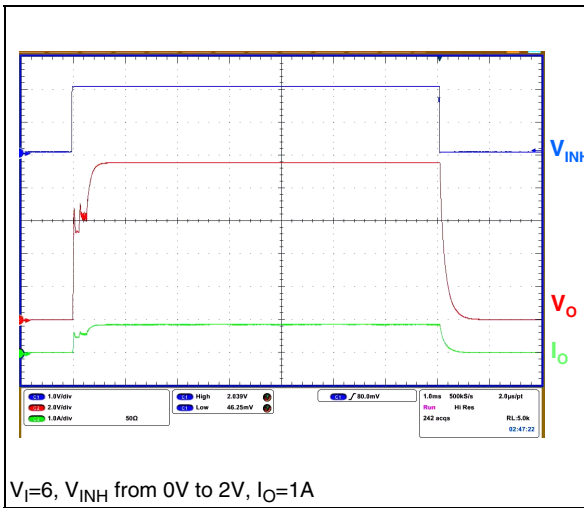
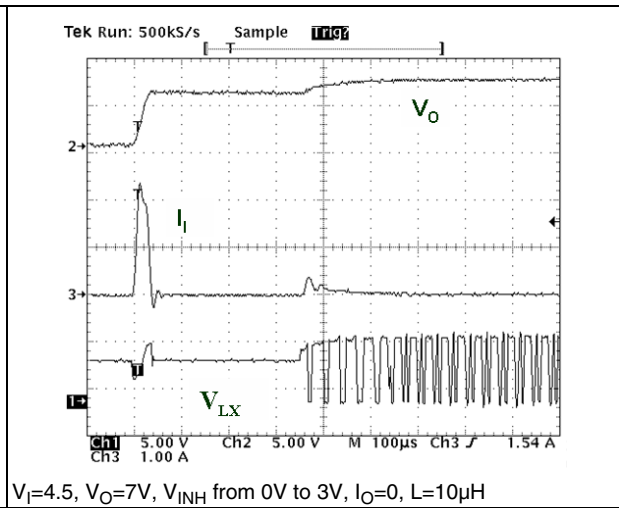

Figure 31. Inrush current



7 Package mechanical data

In order to meet environmental requirements, ST offers these devices in ECOPACK® packages. These packages have a Lead-free second level interconnect. The category of second Level Interconnect is marked on the package and on the inner box label, in compliance with JEDEC Standard JESD97. The maximum ratings related to soldering conditions are also marked on the inner box label. ECOPACK is an ST trademark. ECOPACK specifications are available at: www.st.com.

DFN8 (4x4) Mechanical Data

Dim.	mm.			inch.		
	Min.	Typ.	Max.	Min.	Typ.	Max.
A	0.80	0.90	1.00	0.031	0.035	0.039
A1	0	0.02	0.05	0	0.001	0.002
A3		0.20			0.008	
b	0.23	0.30	0.38	0.009	0.012	0.015
D	3.90	4.00	4.10	0.154	0.157	0.161
D2	2.82	3.00	3.23	0.111	0.118	0.127
E	3.90	4.00	4.10	0.154	0.157	0.161
E2	2.05	2.20	2.30	0.081	0.087	0.091
e		0.80			0.031	
L	0.40	0.50	0.60	0.016	0.020	0.024

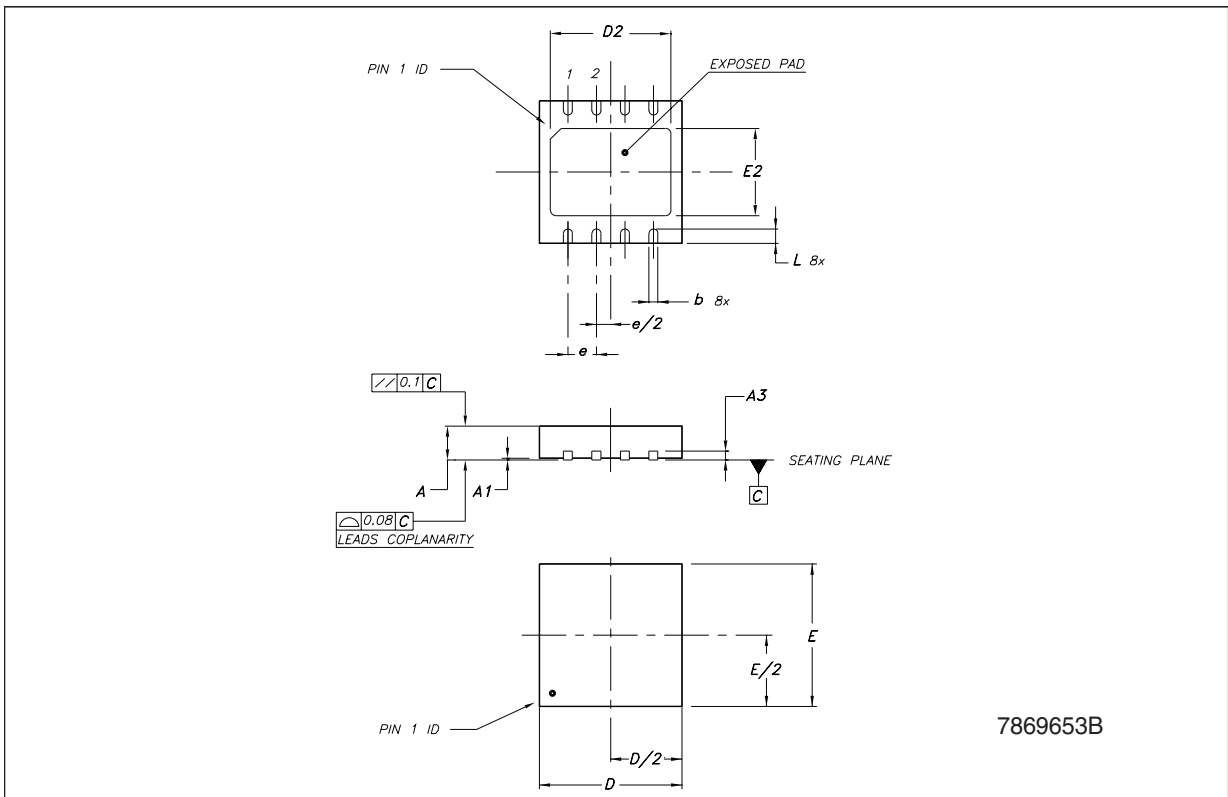
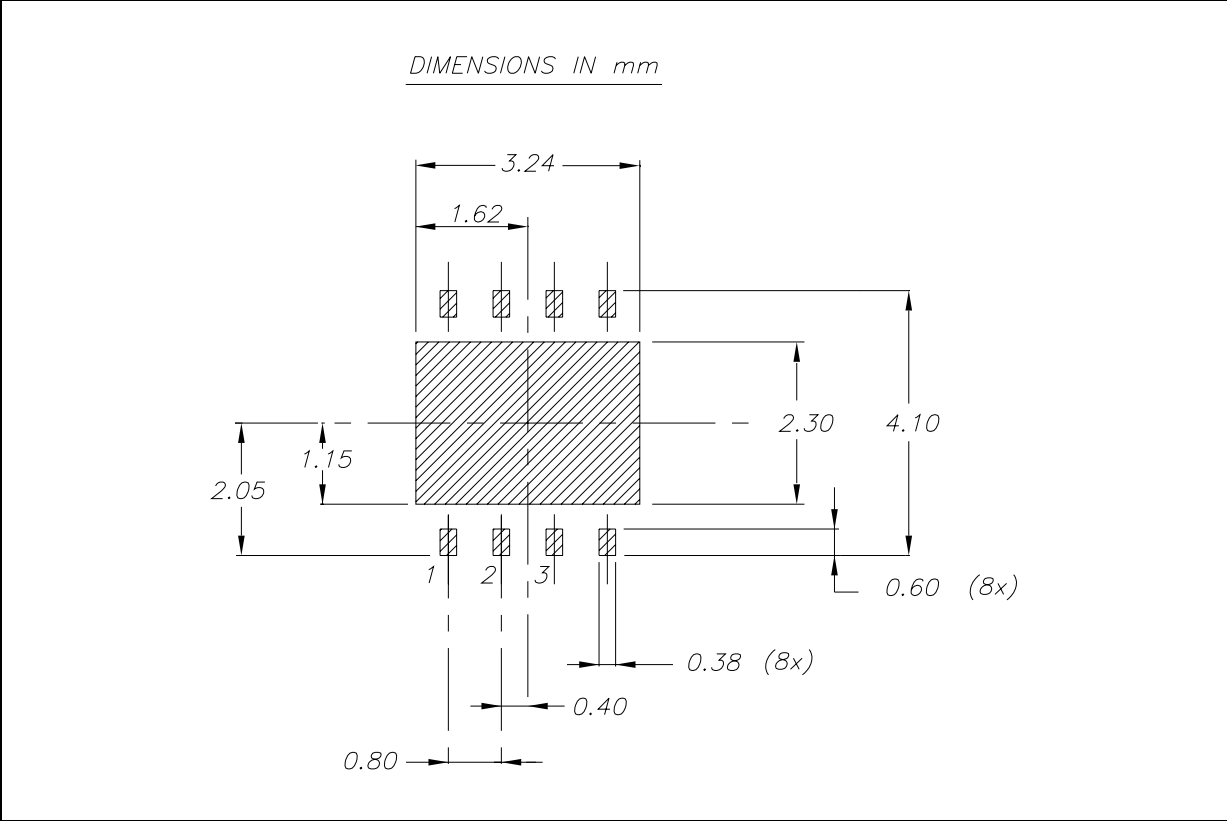
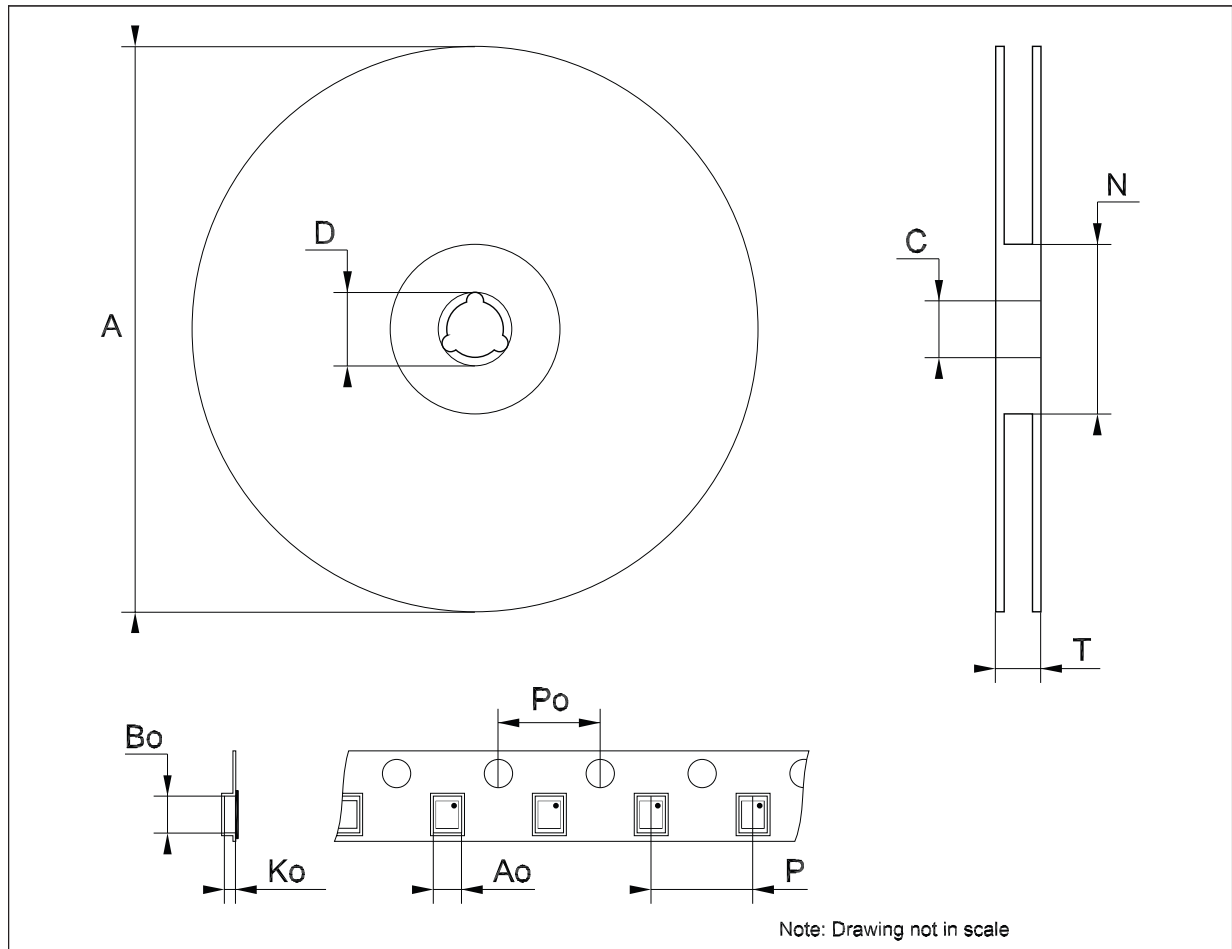

Figure 32. DFN8 (4x4) Footprint Recommended Data



Tape & Reel QFNxx/DFNxx (4x4) Mechanical Data

Dim.	mm.			inch.		
	Min.	Typ.	Max.	Min.	Typ.	Max.
A			330			12.992
C	12.8		13.2	0.504		0.519
D	20.2			0.795		
N	99		101	3.898		3.976
T			14.4			0.567
Ao		4.35			0.171	
Bo		4.35			0.171	
Ko		1.1			0.043	
Po		4			0.157	
P		8			0.315	



8 Revision history

Table 7. Revision history

Date	Revision	Changes
23-May-2007	1	Initial release.

Please Read Carefully:

Information in this document is provided solely in connection with ST products. STMicroelectronics NV and its subsidiaries ("ST") reserve the right to make changes, corrections, modifications or improvements, to this document, and the products and services described herein at any time, without notice.

All ST products are sold pursuant to ST's terms and conditions of sale.

Purchasers are solely responsible for the choice, selection and use of the ST products and services described herein, and ST assumes no liability whatsoever relating to the choice, selection or use of the ST products and services described herein.

No license, express or implied, by estoppel or otherwise, to any intellectual property rights is granted under this document. If any part of this document refers to any third party products or services it shall not be deemed a license grant by ST for the use of such third party products or services, or any intellectual property contained therein or considered as a warranty covering the use in any manner whatsoever of such third party products or services or any intellectual property contained therein.

UNLESS OTHERWISE SET FORTH IN ST'S TERMS AND CONDITIONS OF SALE ST DISCLAIMS ANY EXPRESS OR IMPLIED WARRANTY WITH RESPECT TO THE USE AND/OR SALE OF ST PRODUCTS INCLUDING WITHOUT LIMITATION IMPLIED WARRANTIES OF MERCHANTABILITY, FITNESS FOR A PARTICULAR PURPOSE (AND THEIR EQUIVALENTS UNDER THE LAWS OF ANY JURISDICTION), OR INFRINGEMENT OF ANY PATENT, COPYRIGHT OR OTHER INTELLECTUAL PROPERTY RIGHT.

UNLESS EXPRESSLY APPROVED IN WRITING BY AN AUTHORIZED ST REPRESENTATIVE, ST PRODUCTS ARE NOT RECOMMENDED, AUTHORIZED OR WARRANTED FOR USE IN MILITARY, AIR CRAFT, SPACE, LIFE SAVING, OR LIFE SUSTAINING APPLICATIONS, NOR IN PRODUCTS OR SYSTEMS WHERE FAILURE OR MALFUNCTION MAY RESULT IN PERSONAL INJURY, DEATH, OR SEVERE PROPERTY OR ENVIRONMENTAL DAMAGE. ST PRODUCTS WHICH ARE NOT SPECIFIED AS "AUTOMOTIVE GRADE" MAY ONLY BE USED IN AUTOMOTIVE APPLICATIONS AT USER'S OWN RISK.

Resale of ST products with provisions different from the statements and/or technical features set forth in this document shall immediately void any warranty granted by ST for the ST product or service described herein and shall not create or extend in any manner whatsoever, any liability of ST.

ST and the ST logo are trademarks or registered trademarks of ST in various countries.

Information in this document supersedes and replaces all information previously supplied.

The ST logo is a registered trademark of STMicroelectronics. All other names are the property of their respective owners.

© 2007 STMicroelectronics - All rights reserved

STMicroelectronics group of companies

Australia - Belgium - Brazil - Canada - China - Czech Republic - Finland - France - Germany - Hong Kong - India - Israel - Italy - Japan - Malaysia - Malta - Morocco - Singapore - Spain - Sweden - Switzerland - United Kingdom - United States of America

www.st.com