



2200 Keyboard for public environments. Application / Engineering Manual



USA OFFICE
364 Pennsylvania Avenue, Suite 202
Glen Ellyn
Illinois 60137
USA
Tel +1 (630) 469 2981

UK OFFICE
14 Bentinck Court,
Bentinck Road,
West Drayton UB7 7RQ
ENGLAND
Tel +44 (1895) 431421

www.keymat.com email: sales@keymat.com

This document is provided for use and guidance of engineering personnel engaged in the installation or application of STORM data entry products manufactured by Keymat Technology Ltd. Please be advised that all information, data, and illustrations contained within this document remain the exclusive property of Keymat Technology Ltd. and are provided for the express and exclusive use as described above. This document is not supported by Keymat Technology's engineering change note, revision or reissue system. Data contained within this document is subject to periodic revision, reissue or withdrawal. Whilst every effort is made to ensure the information, data and illustrations are correct at the time of publication, Keymat Technology Ltd. are not responsible for any errors or omissions contained within this document.



Table of Contents

<u>Section</u>	<u>Page</u>
Section 1. Overview of Product Range.....	3
Section 2. Options.....	4
Section 3. Ratings and Performance.....	5
Section 4. Connectors and Connections.....	6
Connections	
Fitting Cables	
Pinout Details.....	7
Section 5. Installation in host equipment	8
Underpanel use	
Benchtop use	
Section 6. Availability/Reliability/Maintainability.....	9
Servicability	
Warranty	
Installation Quickstart guide.....	10
Ordering Details, Part Numbering.....	11
Appendix 1. Language Layouts	
Appendix 2 Panel Cutouts and Mounting Details	
Appendix 3. Code Tables	

This document is provided for use and guidance of engineering personnel engaged in the installation or application of STORM data entry products manufactured by Keymat Technology Ltd. Please be advised that all information, data, and illustrations contained within this document remain the exclusive property of Keymat Technology Ltd. and are provided for the express and exclusive use as described above. This document is not supported by Keymat Technology's engineering change note, revision or reissue system. Data contained within this document is subject to periodic revision, reissue or withdrawal. Whilst every effort is made to ensure the information, data and illustrations are correct at the time of publication, Keymat Technology Ltd. are not responsible for any errors or omissions contained within this document.

Section 1. Overview of Product Range

Developed for use in kiosk applications this range of Keyboards is suitable for use in exposed or hostile environments. Their robust construction is highly resistant to hard use, abuse and vandalism. They are sealed against water and dust to ensure responsive and reliable data entry in the most demanding situations.

**2210 Keyboard, Vandal Resistant
Small Footprint
290mm x 118mm overall size**



**2210 Keyboard, Vandal Resistant
Small Footprint plus trackerball
360mm x 118mm overall size**



**2220 Keyboard. Vandal Resistant
Additional Function Keys
Medium Footprint 290mm x 137mm overall size**



**2230 Keyboard. QWERTY Layout,
Vandal Resistant Function Keys + Num. pad,
Large Footprint 346mm x 137mm overall size**



This document is provided for use and guidance of engineering personnel engaged in the installation or application of STORM data entry products manufactured by Keymat Technology Ltd. Please be advised that all information, data, and illustrations contained within this document remain the exclusive property of Keymat Technology Ltd. and are provided for the express and exclusive use as described above. This document is not supported by Keymat Technology's engineering change note, revision or reissue system. Data contained within this document is subject to periodic revision, reissue or withdrawal. Whilst every effort is made to ensure the information, data and illustrations are correct at the time of publication, Keymat Technology Ltd. are not responsible for any errors or omissions contained within this document.

Section 2. Options

2210

2220

2230



QWERTY KEYBOARD
(61 KEYS)



QWERTY + EXTRA ROW OF
FUNCTION KEYS
(75 KEYS)



QWERTY + EXTRA ROW OF
FUNCTION KEYS + NUMERIC
PAD
(92 KEYS)

(NB Double Space Bar counts as one key in all versions)

Build Style

Vandal Resistant (stainless steel top plate)	<input type="checkbox"/>	<input type="checkbox"/>	<input type="checkbox"/>
--	--------------------------	--------------------------	--------------------------

Keytops

Black Keytops laser marked white	<input type="checkbox"/>	<input type="checkbox"/>	<input type="checkbox"/>
Cast Metal Keytops Chrome Plated	<input type="checkbox"/>	<input type="checkbox"/>	<input type="checkbox"/>

Encoder

PS2	<input checked="" type="checkbox"/>	<input checked="" type="checkbox"/>	<input checked="" type="checkbox"/>
PS2 / USB Selectable	<input type="checkbox"/>	<input type="checkbox"/>	<input type="checkbox"/>

Languages

English UK	<input type="checkbox"/>	<input type="checkbox"/>	<input type="checkbox"/>
English USA	<input type="checkbox"/>	<input type="checkbox"/>	<input type="checkbox"/>
French	<input type="checkbox"/>	<input type="checkbox"/>	
Spanish	<input type="checkbox"/>	<input type="checkbox"/>	
German	<input type="checkbox"/>	<input type="checkbox"/>	

Pointing Devices For Technical Information see document - 2200 Application/Engineering Manual – Trackerball Supplement

Trackerball	<input type="checkbox"/>
-------------	--------------------------

Accessories

Cable with PS2 terminator	<input type="checkbox"/>	<input type="checkbox"/>	<input type="checkbox"/>
Cable with USB terminator	<input type="checkbox"/>	<input type="checkbox"/>	<input type="checkbox"/>
Foot Kit	<input type="checkbox"/>	<input type="checkbox"/>	<input type="checkbox"/>
Underpanel Mounting Kit	<input type="checkbox"/>	<input type="checkbox"/>	<input type="checkbox"/>

NB : Not suitable for keyboard with
integral trackerball

Key : Available as standard Available as an option

This document is provided for use and guidance of engineering personnel engaged in the installation or application of STORM data entry products manufactured by Keymat Technology Ltd. Please be advised that all information, data, and illustrations contained within this document remain the exclusive property of Keymat Technology Ltd. and are provided for the express and exclusive use as described above. This document is not supported by Keymat Technology's engineering change note, revision or reissue system. Data contained within this document is subject to periodic revision, reissue or withdrawal. Whilst every effort is made to ensure the information, data and illustrations are correct at the time of publication, Keymat Technology Ltd. are not responsible for any errors or omissions contained within this document.

Section 3. Ratings and Performance

The 2200 Series keyboard range is designed to meet the following requirements. Validation is by in-house test and additional third party assessment by an accredited test house, where appropriate. Storm 2200 Series keyboards are a UL Recognized Component.

DESCRIPTION	REFERENCE	RELATED BASIC STANDARD OR TEST METHOD
Electrical		
EMC Emissions	EN55022 : 1998 Class B Limit	*
	FCC CFR 47 Part 15 Class B	*
EMC Immunity to ESD	EN55024 : 1998	EN 61000-4-2 :1995 ± 8kV Air ± 4kV Contact
EMC Immunity to Radiated Fields	EN55024 : 1998	EN61000-4-3 :1996
Electrical Safety	EN60950, UL60950 UL Recognized Component E230121	
Communication	Industry Standard PS2 or USB Interface	
Supply requirements – Voltage	+ 5V nominal (5.5 V to 4.75 V)	
Supply requirements – Current	60mA (with 2 LEDs illuminated)	
Environmental		
Sealing – Water / Particulates	EN60529 (sealing to IP65)	
Temperature	-20 °C to + 75 °C operating (dry)	
Mechanical		
Impact resistance	20 Joules via 50mm dia steel striker	
Key pitch	19mm	
Size	11mm square	
Travel	1.5mm nominal	
Actuation force	130g nominal	
Flammability of Major Plastic Parts	Keytops UL94 HB Moulding UL94 V-0 PCB UL94 V-0 Actuators UL94 HB	

This document is provided for use and guidance of engineering personnel engaged in the installation or application of STORM data entry products manufactured by Keymat Technology Ltd. Please be advised that all information, data, and illustrations contained within this document remain the exclusive property of Keymat Technology Ltd. and are provided for the express and exclusive use as described above. This document is not supported by Keymat Technology's engineering change note, revision or reissue system. Data contained within this document is subject to periodic revision, reissue or withdrawal. Whilst every effort is made to ensure the information, data and illustrations are correct at the time of publication, Keymat Technology Ltd. are not responsible for any errors or omissions contained within this document.

Section 4. Connectors and Connections

The 2200 range has as standard a selectable output for PS2 or USB. This is configured by the user via a switch on the encoder pcb at the time that the cables are fitted.

Connections

The 2200 keyboard is supplied without a cable so that the user can select the correct cable length and connector type to suit their application. Cables are offered as separately purchased options, or alternatively the user can source their own cable to suit the application. The pinout details for the connectors are shown on the following page.

Option 1 PS2 Minidin connector, straight cable, 2.5 metres long
Option 2 USB connector, straight cable, 2.5 metres long

Fitting Cables

WARNING : THE FOLLOWING MUST BE DONE IN AN ESSD SAFE HANDLING AREA

In order to fit the cable the pod cover on the back of the keyboard must be snapped open, and the molex connector plugged into the corresponding connector on board. Connect the earth tag to the securing nut and tighten. Set the positions of the USB / PS2 selector switches. Ensure the grommet is correctly located into the slot in the pod; this provides strain relief and sealing. Close the pod cover.

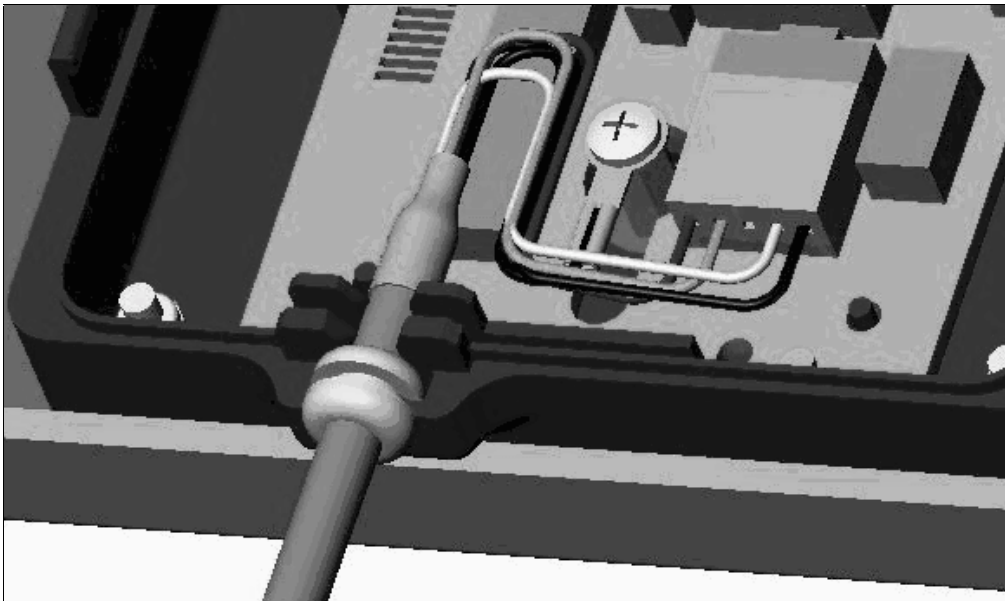

This document is provided for use and guidance of engineering personnel engaged in the installation or application of STORM data entry products manufactured by Keymat Technology Ltd. Please be advised that all information, data, and illustrations contained within this document remain the exclusive property of Keymat Technology Ltd. and are provided for the express and exclusive use as described above. This document is not supported by Keymat Technology's engineering change note, revision or reissue system. Data contained within this document is subject to periodic revision, reissue or withdrawal. Whilst every effort is made to ensure the information, data and illustrations are correct at the time of publication, Keymat Technology Ltd. are not responsible for any errors or omissions contained within this document.

Picture of each end of cable showing pin designations

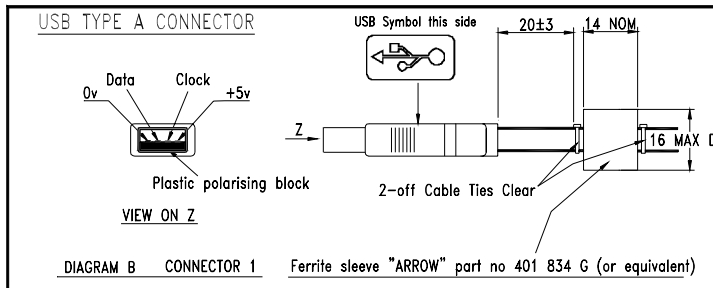
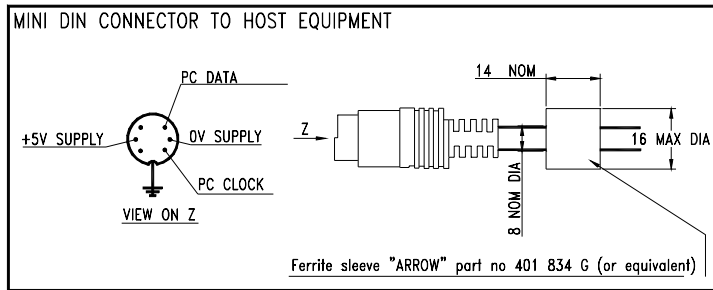
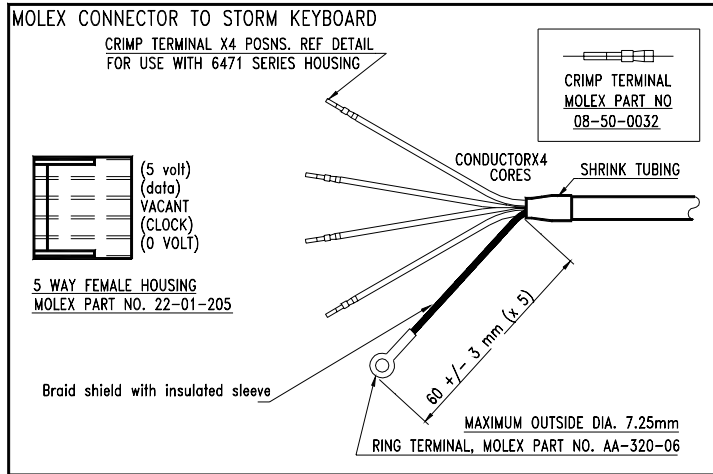

This document is provided for use and guidance of engineering personnel engaged in the installation or application of STORM data entry products manufactured by Keymat Technology Ltd. Please be advised that all information, data, and illustrations contained within this document remain the exclusive property of Keymat Technology Ltd. and are provided for the express and exclusive use as described above. This document is not supported by Keymat Technology's engineering change note, revision or reissue system. Data contained within this document is subject to periodic revision, reissue or withdrawal. Whilst every effort is made to ensure the information, data and illustrations are correct at the time of publication, Keymat Technology Ltd. are not responsible for any errors or omissions contained within this document.

Section 5. Installation in host equipment

Underpanel use

The panel cutout sizes and space requirements for each size of 2200 keyboard are shown in Appendix 2
The overall requirements are as shown below

	2210	2210 TB	2220	2230
Overall Length mm (in)	290.0 (11.4 in)	360.0 (14.2 in)	290.0 (11.4 in)	346.5 (13.6 in)
Overall Width mm (in)	117.6 (4.6 in)	117.6 (4.6 in)	136.5 (5.4 in)	136.5 (5.4 in)
Overall Depth mm (in)	18,5 plus 20 for pod (1.5 in. total)	18,5 plus 20 for pod (1.5 in. total)	18,5 plus 20 for pod (1.5 in. total)	18,5 plus 20 for pod (1.5 in. total)
Weight Kg.	1.05	1.8	1.5	2.2
Underpanel cut out aperture dimensions (in) Panel thickness generally 2mm	280.5 x 109.5 (11.0 x 4.3 in)	351.0 x 109.5	280.5 x 128.5 (11.0 x 5.0 in)	337.5 x 128.5

The 2200 keyboard is designed to be mounted underpanel onto M3 studs, using the separately supplied mounting kit. See figure below for a scrap view.

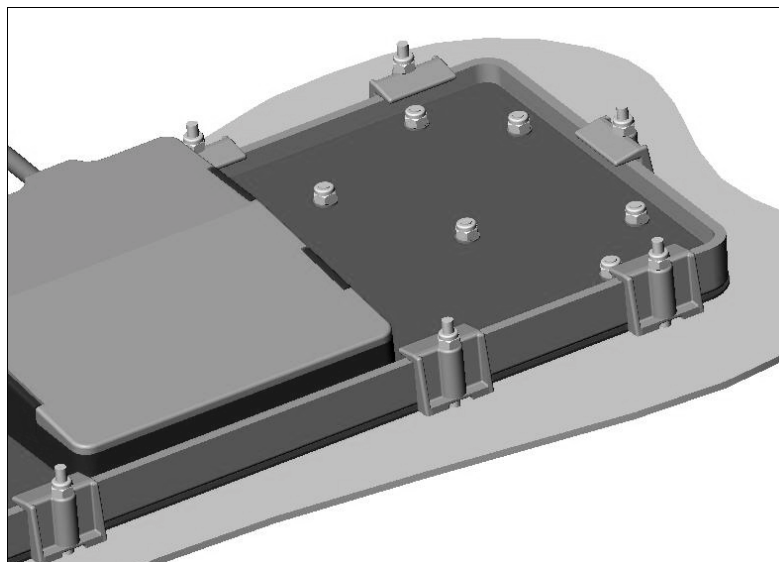

Benchtop use

For use on top of a bench the 2200 requires a foot mounting kit (containing non-slip rubber feet) to be purchased separately and fitted to the rear of the unit prior to use. Note that this kit is not suitable for the trackerball unit.

This document is provided for use and guidance of engineering personnel engaged in the installation or application of STORM data entry products manufactured by Keymat Technology Ltd. Please be advised that all information, data, and illustrations contained within this document remain the exclusive property of Keymat Technology Ltd. and are provided for the express and exclusive use as described above. This document is not supported by Keymat Technology's engineering change note, revision or reissue system. Data contained within this document is subject to periodic revision, reissue or withdrawal. Whilst every effort is made to ensure the information, data and illustrations are correct at the time of publication, Keymat Technology Ltd. are not responsible for any errors or omissions contained within this document.

Section 6. Availability/Reliability/Maintainability.

Firmware

The firmware version is shown on the back of the microchip controller (visible when the pod is open).

Serviceability .

All STORM 2200 Series Keyboards are assembled in a clean purpose designed static free environment. Advanced and closely controlled cellular manufacturing techniques are used to ensure the keyboard remains responsive and reliable throughout it's operational life. The space enclosed within the keyboard casing is subjected to a vacuum test bar to establish a warranted and consistent water seal. For this reason the keyboard's performance, reliability and warranty will be compromised by any tampering or disassembly of major components.

As cables can become damaged in use, the keyboard's 'Interface Pod' [located on the keyboard's under surface] is designed to permit replacement or repair of the cable by any competent technician. If the selected STORM keyboard features a tracker ball, design provision has been made for the tracker ball to be replaced without disturbing the sealed section of the keyboard housing. Only STORM approved replacement parts should be used to ensure continued performance and reliability. The use of non-approved replacement parts may result in reduced performance and invalidated warranty.

The keyboard should be regularly cleaned by washing the operational surface with weak solution of detergent and water. Care should be taken to ensure that no liquids enter the rear face of the keyboard or the connector mechanism.

Warranty

Policy Statement

It is Keymat Technology's intention to provide a fair and rapid response when any customer reports a defect in any product supplied by Keymat Technology.

If a valid warranty claim is received, then it is our policy to repair, replace or provide a credit note for those defective products as quickly as possible and with minimum inconvenience to our customers.

Exclusions

Product shipped more than 12 months before the date of claim are not covered by warranty.

Product damaged by inappropriate use is not covered by warranty.

Product that has been modified is not covered by warranty.

Product where the serial numbers/ batch numbers have been removed or modified are not covered by warranty.

QUICKSTART GUIDE

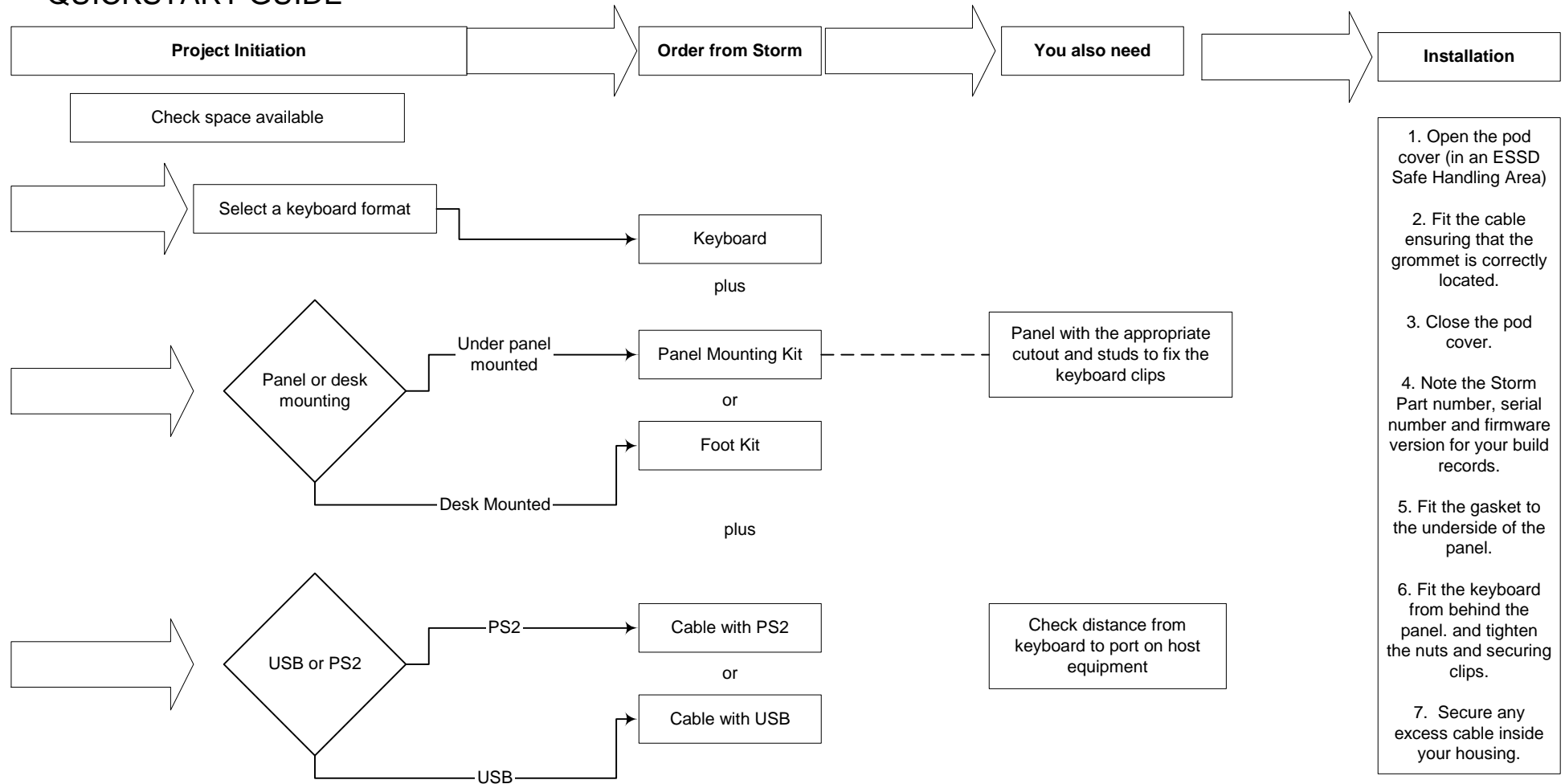

This document is provided for use and guidance of engineering personnel engaged in the installation or application of STORM data entry products manufactured by Keymat Technology Ltd. Please be advised that all information, data, and illustrations contained within this document remain the exclusive property of Keymat Technology Ltd. and are provided for the express and exclusive use as described above. This document is not supported by Keymat Technology's engineering change note, revision or reissue system. Data contained within this document is subject to periodic revision, reissue or withdrawal. Whilst every effort is made to ensure the information, data and illustrations are correct at the time of publication, Keymat Technology Ltd. are not responsible for any errors or omissions contained within this document.

Appendix 1: Keyboard Layouts.

2210 UK Layout

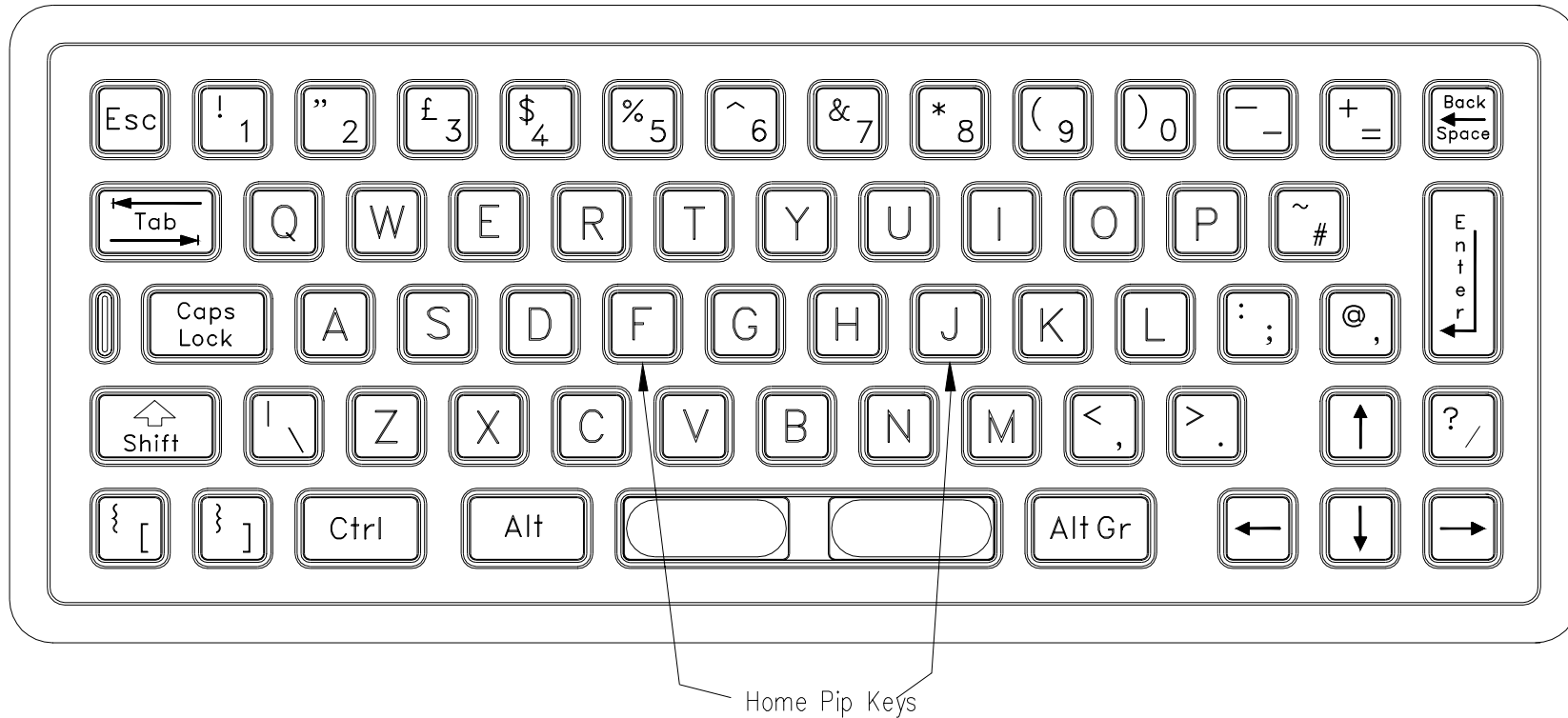

This document is provided for use and guidance of engineering personnel engaged in the installation or application of STORM data entry products manufactured by Keymat Technology Ltd. Please be advised that all information, data, and illustrations contained within this document remain the exclusive property of Keymat Technology Ltd. and are provided for the express and exclusive use as described above. This document is not supported by Keymat Technology's engineering change note, revision or reissue system. Data contained within this document is subject to periodic revision, reissue or withdrawal. Whilst every effort is made to ensure the information, data and illustrations are correct at the time of publication, Keymat Technology Ltd. are not responsible for any errors or omissions contained within this document.

2210 US Layout

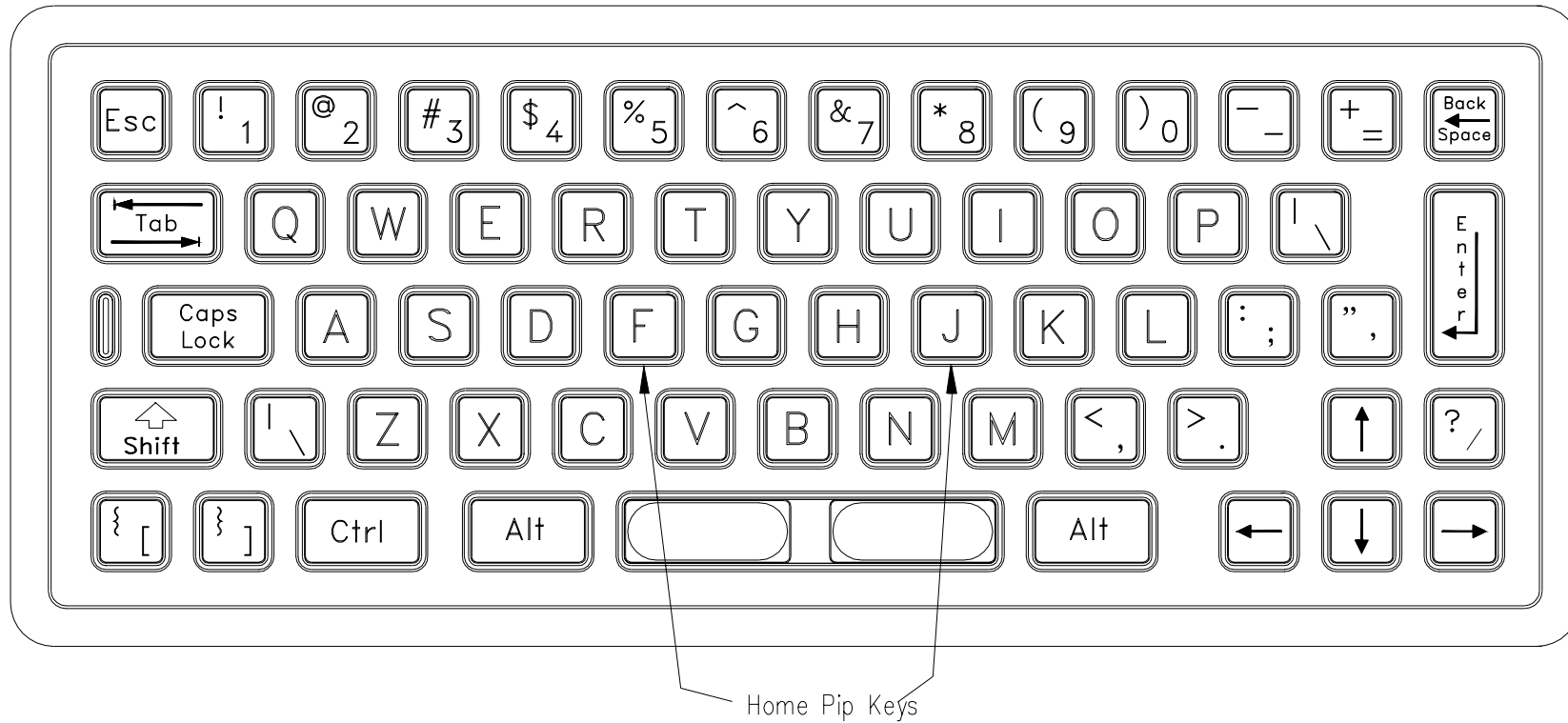

This document is provided for use and guidance of engineering personnel engaged in the installation or application of STORM data entry products manufactured by Keymat Technology Ltd. Please be advised that all information, data, and illustrations contained within this document remain the exclusive property of Keymat Technology Ltd. and are provided for the express and exclusive use as described above. This document is not supported by Keymat Technology's engineering change note, revision or reissue system. Data contained within this document is subject to periodic revision, reissue or withdrawal. Whilst every effort is made to ensure the information, data and illustrations are correct at the time of publication, Keymat Technology Ltd. are not responsible for any errors or omissions contained within this document.

Appendix 2.
Panel Mounting Details
2210 Keyboard (no trackerball)

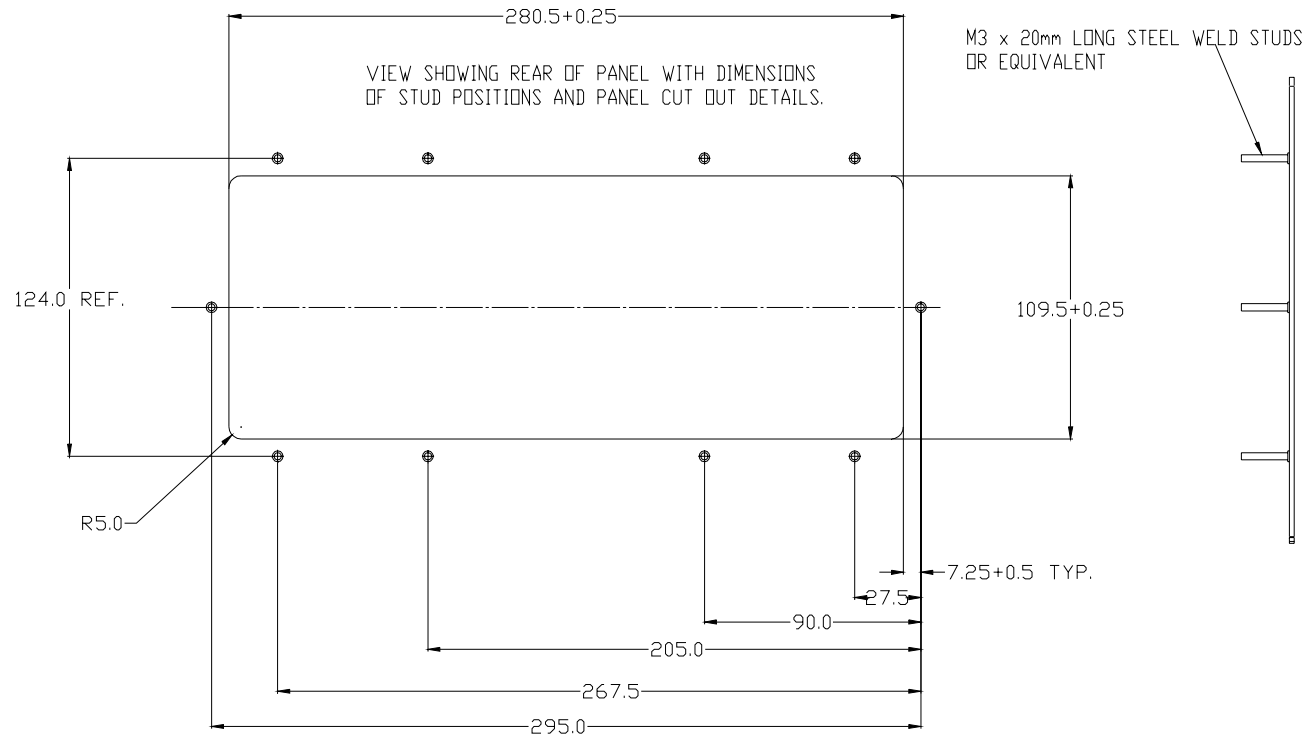

This document is provided for use and guidance of engineering personnel engaged in the installation or application of STORM data entry products manufactured by Keymat Technology Ltd. Please be advised that all information, data, and illustrations contained within this document remain the exclusive property of Keymat Technology Ltd. and are provided for the express and exclusive use as described above. This document is not supported by Keymat Technology's engineering change note, revision or reissue system. Data contained within this document is subject to periodic revision, reissue or withdrawal. Whilst every effort is made to ensure the information, data and illustrations are correct at the time of publication, Keymat Technology Ltd. are not responsible for any errors or omissions contained within this document.

Panel Mounting Details 2210 Keyboard (with trackerball)

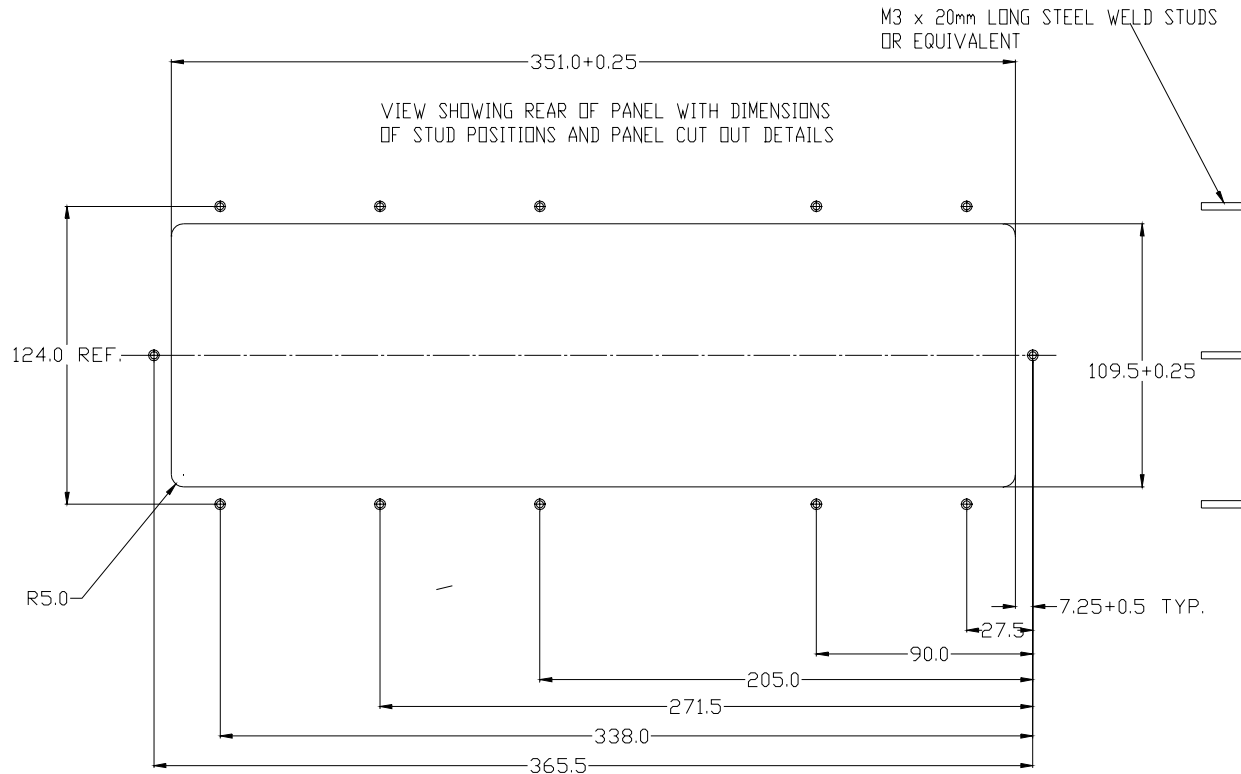

This document is provided for use and guidance of engineering personnel engaged in the installation or application of STORM data entry products manufactured by Keymat Technology Ltd. Please be advised that all information, data, and illustrations contained within this document remain the exclusive property of Keymat Technology Ltd. and are provided for the express and exclusive use as described above. This document is not supported by Keymat Technology's engineering change note, revision or reissue system. Data contained within this document is subject to periodic revision, reissue or withdrawal. Whilst every effort is made to ensure the information, data and illustrations are correct at the time of publication, Keymat Technology Ltd. are not responsible for any errors or omissions contained within this document.

Panel Mounting Details 2220 Keyboard

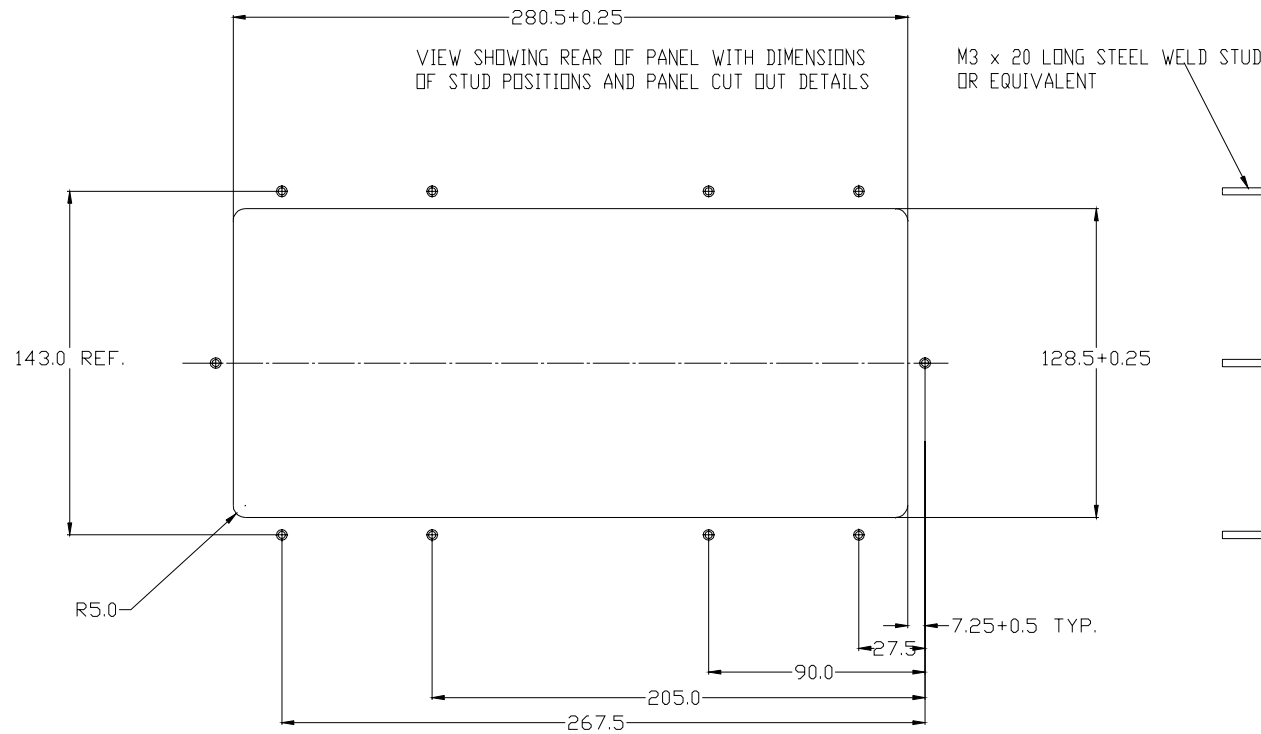

This document is provided for use and guidance of engineering personnel engaged in the installation or application of STORM data entry products manufactured by Keymat Technology Ltd. Please be advised that all information, data, and illustrations contained within this document remain the exclusive property of Keymat Technology Ltd. and are provided for the express and exclusive use as described above. This document is not supported by Keymat Technology's engineering change note, revision or reissue system. Data contained within this document is subject to periodic revision, reissue or withdrawal. Whilst every effort is made to ensure the information, data and illustrations are correct at the time of publication, Keymat Technology Ltd. are not responsible for any errors or omissions contained within this document.

Panel Mounting Details 2230 Keyboard

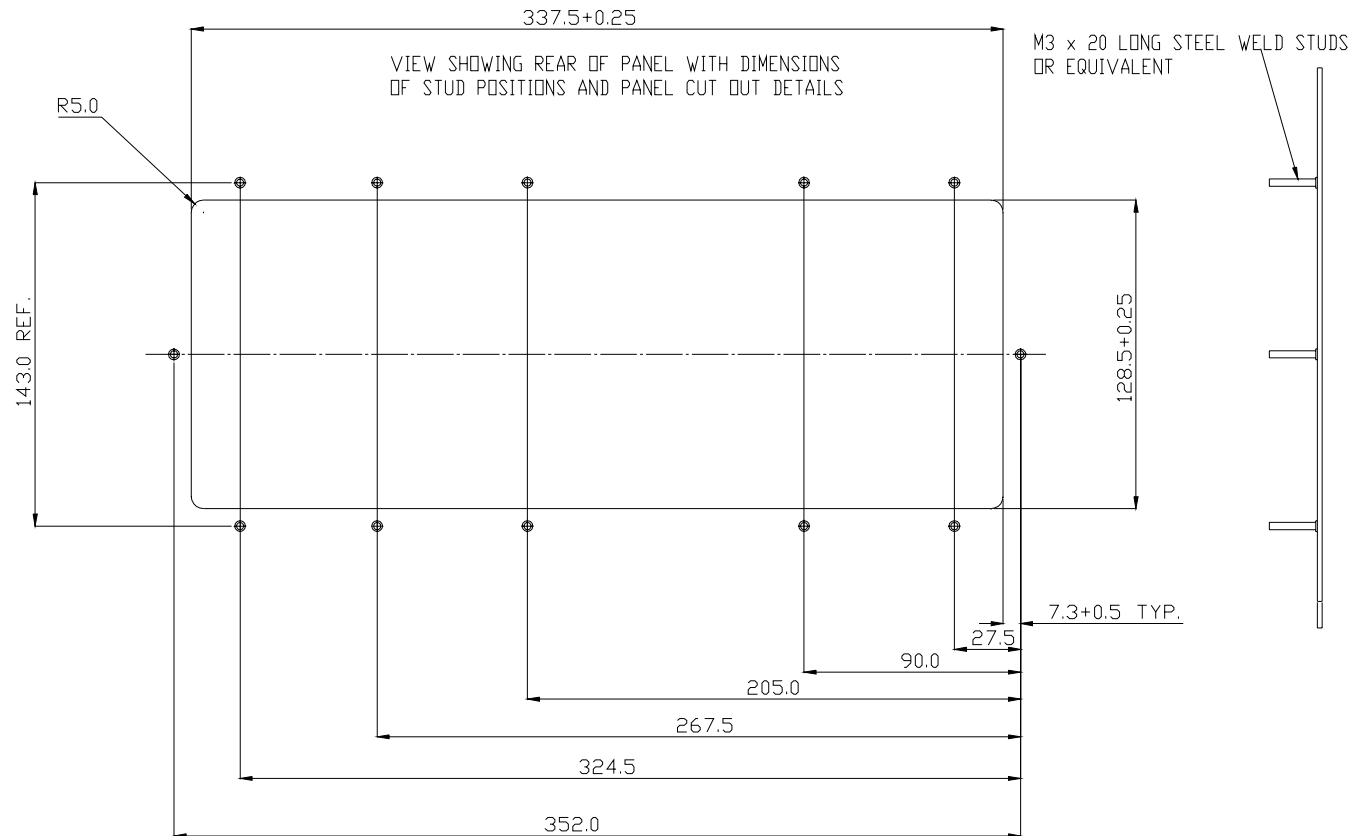

This document is provided for use and guidance of engineering personnel engaged in the installation or application of STORM data entry products manufactured by Keymat Technology Ltd. Please be advised that all information, data, and illustrations contained within this document remain the exclusive property of Keymat Technology Ltd. and are provided for the express and exclusive use as described above. This document is not supported by Keymat Technology's engineering change note, revision or reissue system. Data contained within this document is subject to periodic revision, reissue or withdrawal. Whilst every effort is made to ensure the information, data and illustrations are correct at the time of publication, Keymat Technology Ltd. are not responsible for any errors or omissions contained within this document.

2210 Positions and Codes.

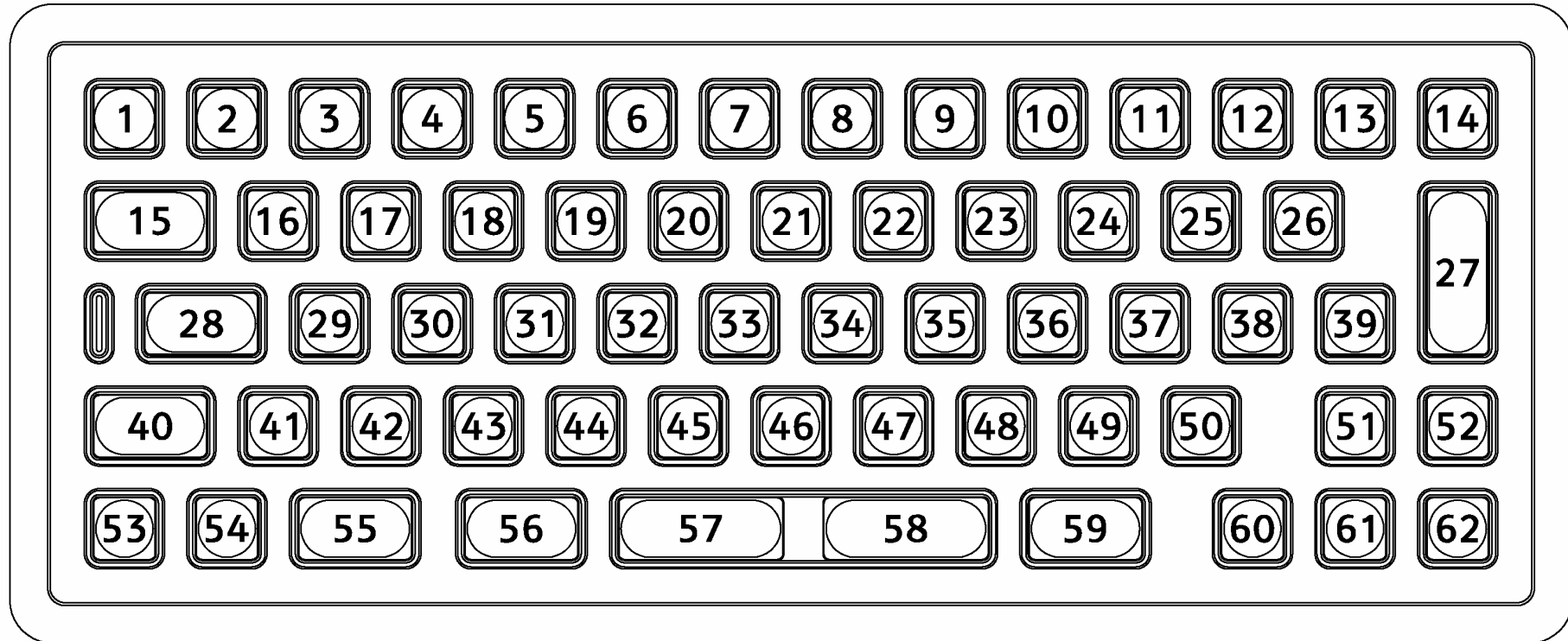

This document is provided for use and guidance of engineering personnel engaged in the installation or application of STORM data entry products manufactured by Keymat Technology Ltd. Please be advised that all information, data, and illustrations contained within this document remain the exclusive property of Keymat Technology Ltd. and are provided for the express and exclusive use as described above. This document is not supported by Keymat Technology's engineering change note, revision or reissue system. Data contained within this document is subject to periodic revision, reissue or withdrawal. Whilst every effort is made to ensure the information, data and illustrations are correct at the time of publication, Keymat Technology Ltd. are not responsible for any errors or omissions contained within this document.



2200 Keyboard for public environments. Application / Engineering Manual

Key Position	Row / Column	2210 UK Layout.		2210 US Layout.		PC/AT Code (Code Set 2)
		Base	Shifted	Base	Shifted	
1	R0C0	Escape		Escape		76
2	R1C1	1	!	1	!	16
3	R1C2	2	“	2	@	1E
4	R1C3	3	£	3	#	26
5	R1C4	4	\$	4	\$	25
6	R1C5	5	%	5	%	2E
7	R1C6	6	^	6	^	36
8	R1C7	7	&	7	&	3D
9	R1C8	8	*	8	*	3E
10	R1C9	9	(9	(46
11	R1C10	0)	0)	45
12	R1C11	-	_	-	_	4E
13	R1C55	=	+	=	+	55
14	R3C12	Backspace		Backspace		66
15	R2C0	Tab		Tab		0D
16	R2C1	Q	Q	q	Q	15
17	R2C2	W	W	w	W	1D
18	R2C3	E	E	e	E	24
19	R2C4	R	R	r	R	2D
20	R2C5	T	T	t	T	2C
21	R2C6	Y	Y	y	Y	35
22	R2C7	U	U	u	U	3C
23	R2C8	I	I	i	I	43
24	R2C9	O	O	o	O	44
25	R2C10	P	P	p	P	4D
26	R2C11	#	~	\		5D
27	R4C12	Enter		Enter		5A
28	R4C0	Caps		Caps		58
29	R3C1	A	A	a	A	1C
30	R3C2	S	S	s	S	1B
31	R3C3	D	D	d	D	23
32	R3C4	F	F	f	F	2B
33	R3C5	G	G	g	G	34
34	R3C6	H	H	h	H	33
35	R3C7	J	J	j	J	3B
36	R3C8	K	K	k	K	42

This document is provided for use and guidance of engineering personnel engaged in the installation or application of STORM data entry products manufactured by Keymat Technology Ltd. Please be advised that all information, data, and illustrations contained within this document remain the exclusive property of Keymat Technology Ltd. and are provided for the express and exclusive use as described above. This document is not supported by Keymat Technology's engineering change note, revision or reissue system. Data contained within this document is subject to periodic revision, reissue or withdrawal. Whilst every effort is made to ensure the information, data and illustrations are correct at the time of publication, Keymat Technology Ltd. are not responsible for any errors or omissions contained within this document.



2200 Keyboard for public environments. Application / Engineering Manual

Key Position	Row / Column	2210 UK Layout.		2210 US Layout.		PC/AT Code (Code Set 2)
		Base	Shifted	Base	Shifted	
37	R3C9	L	L	l	L	4B
38	R3C10	;	:	;	:	4C
39	R3C11	'	@	'	"	52
40	R4C14	Shift		Shift		12
41	R4C1	\		\		61
42	R4C2	Z	Z	z	Z	1A
43	R4CE	X	X	x	X	22
44	R4C4	C	C	c	C	21
45	R4C5	V	V	v	V	2A
46	R4C6	B	B	b	B	32
47	R4C7	N	N	n	N	31
48	R4C8	M	M	m	M	3A
49	R4C9	,	<	,	<	41
50	R4C10	.	>	.	>	49
51	R7C10	↑		↑		E0,75
52	R4C11	/	?	/	?	4A
53	R5C0	[{	[{	54
54	R5C1]	}]	}	5B
55	R5C10	Control		Control		E0,27
56	R6C13	Alt		Alt		11
57	R5C5	Space		Space		29
58	R5C6	Space		Space		29
59	R7C13	Alt Gr		Alt Gr		E0,11
60	R7C9	←		←		E0,6B
61	R7C11	↓		↓		E0,72
62	R7C12	→		→		E0,74

Release Codes.

The PC/AT release code for each key is the Scan Code preceded by H'F0.

Example: Q – H'F0', H'15.

Exception: Keys with Scan Codes starting with H'E0, the release code sequence (for example LEFT ARROW) is as follows: H'E0', H'F0',H'6B.

This document is provided for use and guidance of engineering personnel engaged in the installation or application of STORM data entry products manufactured by Keymat Technology Ltd. Please be advised that all information, data, and illustrations contained within this document remain the exclusive property of Keymat Technology Ltd. and are provided for the express and exclusive use as described above. This document is not supported by Keymat Technology's engineering change note, revision or reissue system. Data contained within this document is subject to periodic revision, reissue or withdrawal. Whilst every effort is made to ensure the information, data and illustrations are correct at the time of publication, Keymat Technology Ltd. are not responsible for any errors or omissions contained within this document.

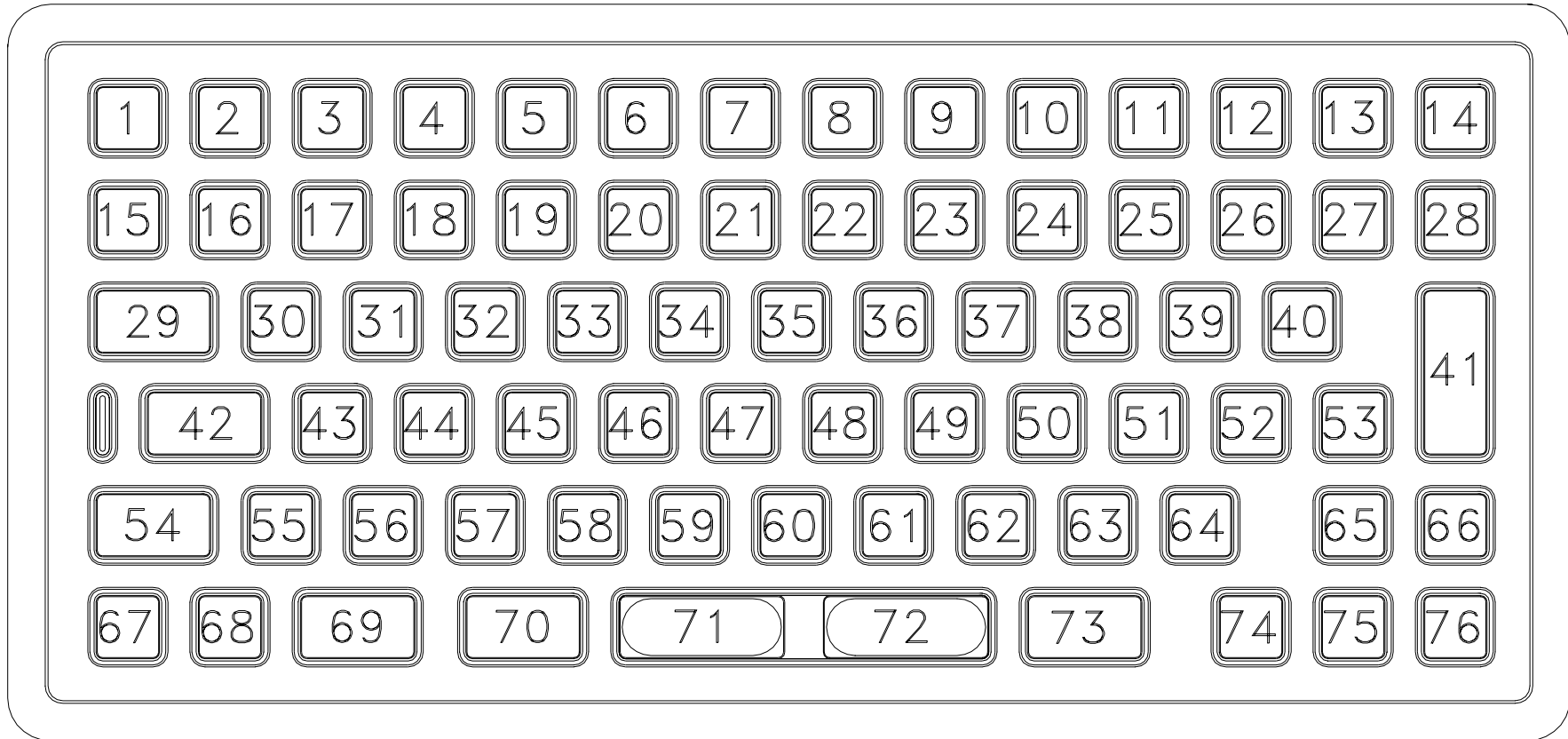

This document is provided for use and guidance of engineering personnel engaged in the installation or application of STORM data entry products manufactured by Keymat Technology Ltd. Please be advised that all information, data, and illustrations contained within this document remain the exclusive property of Keymat Technology Ltd. and are provided for the express and exclusive use as described above. This document is not supported by Keymat Technology's engineering change note, revision or reissue system. Data contained within this document is subject to periodic revision, reissue or withdrawal. Whilst every effort is made to ensure the information, data and illustrations are correct at the time of publication, Keymat Technology Ltd. are not responsible for any errors or omissions contained within this document.



2200 Keyboard for public environments. Application / Engineering Manual

Key Position	Row / Column	2220 UK Layout.			2220 US Layout.		PC/AT Code (Code Set 2)
		Base	Shifted	Ctrl+Alt	Base	Shifted	
1	R0C0	Escape			Escape		76
2	R0C1	F1			F1		05
3	R0C2	F2			F2		05
4	R0C3	F3			F3		04
5	R0C4	F4			F4		0C
6	R0C5	F5			F5		03
7	R0C6	F6			F6		0B
8	R0C7	F7			F7		83
9	R0C8	F8			F8		0A
10	R0C9	F9			F9		01
11	R0C10	F10			F10		09
12	R0C11	F11			F11		78
13	R0C12	F12			F12		07
14	R3C0	Print Scrn			Print Scrn		E0,2F
15	R1C0	'	¬	;	'	~	0E
16	R1C1	1	!		1	!	16
17	R1C2	2	“		2	@	1E
18	R1C3	3	£		3	#	26
19	R1C4	4	\$		4	\$	25
20	R1C5	5	%		5	%	2E
21	R1C6	6	^		6	^	36
22	R1C7	7	&		7	&	3D
23	R1C8	8	*		8	*	3E
24	R1C9	9	(9	(46
25	R1C10	0)		0)	45
26	R1C11	-	_		-	_	4E

This document is provided for use and guidance of engineering personnel engaged in the installation or application of STORM data entry products manufactured by Keymat Technology Ltd. Please be advised that all information, data, and illustrations contained within this document remain the exclusive property of Keymat Technology Ltd. and are provided for the express and exclusive use as described above. This document is not supported by Keymat Technology's engineering change note, revision or reissue system. Data contained within this document is subject to periodic revision, reissue or withdrawal. Whilst every effort is made to ensure the information, data and illustrations are correct at the time of publication, Keymat Technology Ltd. are not responsible for any errors or omissions contained within this document.



2200 Keyboard for public environments. Application / Engineering Manual

Key Position	Row / Column	2220 UK Layout.			2220 US Layout.		PC/AT Code (Code Set 2)
		Base	Shifted	Ctrl+Alt	Base	Shifted	
27	R1C55	=	+		=	+	55
28	R3C12	Backspace			Backspace		66
29	R2C0	Tab			Tab		0D
30	R2C1	q	Q		q	Q	15
31	R2C2	w	W		w	W	1D
32	R2C3	e	E		e	E	24
33	R2C4	r	R		r	R	2D
34	R2C5	t	T		t	T	2C
35	R2C6	y	Y		y	Y	35
36	R2C7	u	U		u	U	3C
37	R2C8	i	I		i	I	43
38	R2C9	o	O		o	O	44
39	R2C10	p	P		p	P	4D
40	R2C11	#	~		\		5D
41	R4C12	Enter			Enter		5A
42	R4C0	Caps			Caps		58
43	R3C1	a	A		a	A	1C
44	R3C2	s	S		S	S	1B
45	R3C3	d	D		d	D	23
46	R3C4	f	F		f	F	2B
47	R3C5	g	G		g	G	34
48	R3C6	h	H		h	H	33
49	R3C7	j	J		j	J	3B
50	R3C8	k	K		k	K	42
51	R3C9	l	L		l	L	4B
52	R3C10	;	:		;	:	4C
53	R3C11	'	@		'	“	52
54	R4C14	Shift			Shift		12

This document is provided for use and guidance of engineering personnel engaged in the installation or application of STORM data entry products manufactured by Keymat Technology Ltd. Please be advised that all information, data, and illustrations contained within this document remain the exclusive property of Keymat Technology Ltd. and are provided for the express and exclusive use as described above. This document is not supported by Keymat Technology's engineering change note, revision or reissue system. Data contained within this document is subject to periodic revision, reissue or withdrawal. Whilst every effort is made to ensure the information, data and illustrations are correct at the time of publication, Keymat Technology Ltd. are not responsible for any errors or omissions contained within this document.



2200 Keyboard for public environments. Application / Engineering Manual

Key Position	Row / Column	2220 UK Layout.			2220 US Layout.		PC/AT Code (Code Set 2)
		Base	Shifted	Ctrl+Alt	Base	Shifted	
55	R4C1	\			\		61
56	R4C2	z	Z		z	Z	1A
57	R4C3	x	X		x	X	22
58	R4C4	c	C		c	C	21
59	R4C5	v	V		v	V	2A
60	R4C6	b	B		b	B	32
61	R4C7	n	N		n	N	31
62	R4C8	m	M		m	M	3A
63	R4C9	,	<		,	<	41
64	R4C10	.	>		.	>	49
65	R7C10	↑			↑		E0,75
66	R4C11	/	?		/	?	4A
67	R5C0	[{		[{	54
68	R5C1]	}]	}	5B
69	R5C10	Control			Control		E0,27
70	R6C13	Alt			Alt		11
71	R5C5	Space			Space		29
72	R5C6	Space			Space		29
73	R7C13	Alt Gr			Alt Gr		E0,11
74	R7C9	←			←		E0,6B
75	R7C11	↓			↓		E0,72
76	R7C12	→			→		E0,74

Release Codes.

The PC/AT release code for each key is the Scan Code preceded by H'F0.

Example: Q – H'F0', H'15.

Exception: Keys with Scan Codes starting with H'E0, the release code sequence (for example LEFT ARROW) is as follows: H'E0', H'F0', H'6B.

This document is provided for use and guidance of engineering personnel engaged in the installation or application of STORM data entry products manufactured by Keymat Technology Ltd. Please be advised that all information, data, and illustrations contained within this document remain the exclusive property of Keymat Technology Ltd. and are provided for the express and exclusive use as described above. This document is not supported by Keymat Technology's engineering change note, revision or reissue system. Data contained within this document is subject to periodic revision, reissue or withdrawal. Whilst every effort is made to ensure the information, data and illustrations are correct at the time of publication, Keymat Technology Ltd. are not responsible for any errors or omissions contained within this document.

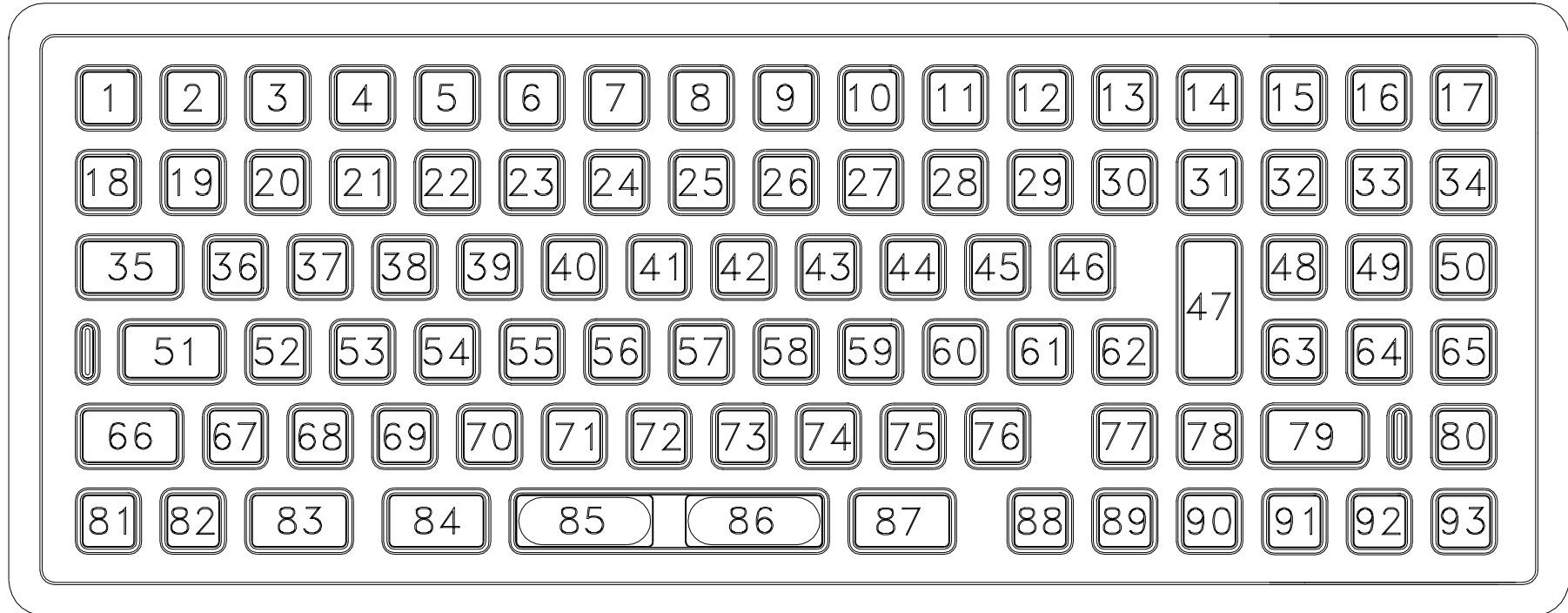

This document is provided for use and guidance of engineering personnel engaged in the installation or application of STORM data entry products manufactured by Keymat Technology Ltd. Please be advised that all information, data, and illustrations contained within this document remain the exclusive property of Keymat Technology Ltd. and are provided for the express and exclusive use as described above. This document is not supported by Keymat Technology's engineering change note, revision or reissue system. Data contained within this document is subject to periodic revision, reissue or withdrawal. Whilst every effort is made to ensure the information, data and illustrations are correct at the time of publication, Keymat Technology Ltd. are not responsible for any errors or omissions contained within this document.



2200 Keyboard for public environments. Application / Engineering Manual

Key Position.	Row / Column	2230 UK Layout.				2230 US Layout.			PC/AT Code (Code Set 2)
		Base	Shifted	Ctrl+Alt	Num Lock	Base	Shifted	Num Lock	
1	R0C0	Escape				Escape			76
2	R0C1	F1				F1			05
3	R0C2	F2				F2			06
4	R0C3	F3				F3			04
5	R0C4	F4				F4			0C
6	R0C5	F5				F5			03
7	R0C6	F6				F6			0B
8	R0C7	F7				F7			83
9	R0C8	F8				F8			0A
10	R0C9	F9				F9			01
11	R0C10	F10				F10			09
12	R0C11	F11				F11			78
13	R0C12	F12				F12			07
14	R3C0	Print Scrn				Print Scrn			E0,2F
15	R0C13	Home			7	Home		7	6C
16	R0C14	↑			8	↑		8	75
17	R0C15	Pg Up			9	Pg Up		9	7D
18	R1C0	‘	¬	¡		‘	~		0E
19	R1C1	1	!			1	!		16
20	R1C2	2	“			2	“		1E
21	R1C3	3	£			3	£		26
22	R1C4	4	\$			4	\$		25
23	R1C5	5	%			5	%		2E
24	R1C6	6	^			6	^		36
25	R1C7	7	&			7	&		3D
26	R1C8	8	*			8	*		3E
27	R1C9	9	(9	(46
28	R1C10	0)			0)		45
29	R1C11	-	_			-	_		4E

This document is provided for use and guidance of engineering personnel engaged in the installation or application of STORM data entry products manufactured by Keymat Technology Ltd. Please be advised that all information, data, and illustrations contained within this document remain the exclusive property of Keymat Technology Ltd. and are provided for the express and exclusive use as described above. This document is not supported by Keymat Technology's engineering change note, revision or reissue system. Data contained within this document is subject to periodic revision, reissue or withdrawal. Whilst every effort is made to ensure the information, data and illustrations are correct at the time of publication, Keymat Technology Ltd. are not responsible for any errors or omissions contained within this document.



2200 Keyboard for public environments. Application / Engineering Manual

Key Position.	Row / Column	2230 UK Layout.				2230 US Layout.			PC/AT Code (Code Set 2)
		Base	Shifted	Ctrl+Alt	Num Lock	Base	Shifted	Num Lock	
30	R1C55	=	+			=	+		55
31	R3C12	Backspace				Backspace			66
32	R1C13	←			4	←		4	6B
33	R1C14				5			5	73
34	R1C15	→			6	→		6	74
35	R2C0	Tab				Tab			0D
36	R2C1	q	Q			q	Q		15
37	R2C2	w	W			w	W		1D
38	R2C3	e	E			e	E		24
39	R2C4	r	R			r	R		2D
40	R2C5	t	T			t	T		2C
41	R2C6	y	Y			y	Y		35
42	R2C7	u	U			u	U		3C
43	R2C8	i	I			i	I		43
44	R2C9	o	O			o	O		44
45	R2C10	p	P			p	P		4D
46	R2C11	#	~			\			5D
47	R4C12	Enter				Enter			5A
48	R2C13	End			1	End		1	69
49	R2C14	↓			2	↓		2	72
50	R2C15	Pg Dn			3	Pg Dn		3	7A
51	R4C0	Caps				Caps			58
52	R3C1	a	A			a	A		1C
53	R3C2	s	S			s	S		1B
54	R3C3	d	D			d	D		23
55	R3C4	f	F			f	F		2B
56	R3C5	g	G			g	G		34
57	R3C6	h	H			h	H		33
58	R3C7	j	J			j	J		3B
59	R3C8	k	K			k	K		42
60	R3C9	l	L			l	L		4B
61	R3C10	;	:			;	:		4C
62	R3C11	'	@			'	“		52
63	R3C13	+				+			79
64	R3C14	Ins			0	Ins		0	70

This document is provided for use and guidance of engineering personnel engaged in the installation or application of STORM data entry products manufactured by Keymat Technology Ltd. Please be advised that all information, data, and illustrations contained within this document remain the exclusive property of Keymat Technology Ltd. and are provided for the express and exclusive use as described above. This document is not supported by Keymat Technology's engineering change note, revision or reissue system. Data contained within this document is subject to periodic revision, reissue or withdrawal. Whilst every effort is made to ensure the information, data and illustrations are correct at the time of publication, Keymat Technology Ltd. are not responsible for any errors or omissions contained within this document.



2200 Keyboard for public environments. Application / Engineering Manual

Key Position.	Row / Column	2230 UK Layout.				2230 US layout.			PC/AT Code (Code Set 2)
		Base	Shifted	Ctrl+Alt	Num Lock	Base	Shifted	Num Lock	
65	R2C12	Del			.	Del		.	71
66	R4C14	Lt Shift				Lt Shift			12
67	R4C1	\				\			61
68	R4C2	z	Z			z	Z		1A
69	R4C3	x	X			x	X		22
70	R4C4	c	C			c	C		21
71	R4C5	v	V			v	V		2A
72	R4C6	b	B			b	B		32
73	R4C7	n	N			n	N		31
74	R4C8	m	M			m	M		3A
75	R4C9	,	<			,	<		41
76	R4C10	.	>			.	>		49
77	R7C10	↑				↑			E0,75
78	R4C11	/	?			/	?		4A
79	R5C14	Rt Shift				Rt Shift			59
80	R5C11	Num Lock				Num Lock			77
81	R5C0	[{			[{		54
82	R5C1]	}]	}		5B
83	R5C10	Lt Control				Lt Control			14
84	R6C13	Lt Alt				Lt Alt			11
85	R5C5	Space				Space			29
86	R5C6	Space				Space			29
87	R7C13	Alt Gr				Alt Gr			E0,11
88	R7C9	←				←			E0,6B
89	R7C11	↓				↓			E0,72
90	R7C12	→				→			E0,74
91	R5C10	Rt Control				Rt Control			E0,27
92	R6C15	www.				www.			1D,1D,1D,49
93	R7C15	.com				.com			49,21,44,3A

Release Codes.

The PC/AT release code for each key is the Scan Code preceded by H'F0. Example: Q – H'F0', H'15.

Exception: Keys with Scan Codes starting with H'E0, the release code sequence (for example LEFT ARROW) is as follows: H'E0', H'F0',H'6B.

This document is provided for use and guidance of engineering personnel engaged in the installation or application of STORM data entry products manufactured by Keymat Technology Ltd. Please be advised that all information, data, and illustrations contained within this document remain the exclusive property of Keymat Technology Ltd. and are provided for the express and exclusive use as described above. This document is not supported by Keymat Technology's engineering change note, revision or reissue system. Data contained within this document is subject to periodic revision, reissue or withdrawal. Whilst every effort is made to ensure the information, data and illustrations are correct at the time of publication, Keymat Technology Ltd. are not responsible for any errors or omissions contained within this document.